



INVISIDOOOR

INVISIBLE ALUMINIUM FRAME
FOR INTERIOR DOORS





ALL TECHNICAL DRAWINGS ARE SHOWN IN MILLIMETRES AND ARE SUBJECT TO CHANGE BY ARLU.

ARLU, THE REFERENCE FOR OPENING DOORS

ARLU® is the manufacturer behind the brand names argenta® and rob®. Argenta has been a leading brand in door hardware for over 100 years, but today it is mainly synonymous with invisible door systems.

Minimalist architecture swears by clean lines and a "back to the essence" mentality. In terms of interior doors, this results in integrated door fittings, invisible integrated techniques, door frames and skirting boards for revolving, sliding and pivoting doors.

Argenta stands for a full range of sleek interior solutions.

01

HINGED DOORS

Thanks to an ingenious aluminium interior door frame, it is possible to achieve integrated doors in walls with a frameless appearance. With the invisidoor® the door is lined up perfectly with the wall allowing architects to create clean lines.

01

HINGED DOORS

- 4 invisidoor® 2.0
- 10 invisidoor®

02

PIVOTING DOORS

- 18 invisidoor® AX / AX Pro

03

POCKET DOORS

- 24 invisidoor® S
- 30 invisidoor® SDX

04

INVISIBLE SKIRTING BOARDS

- 42 invisiplint

05

GENERAL INFORMATION

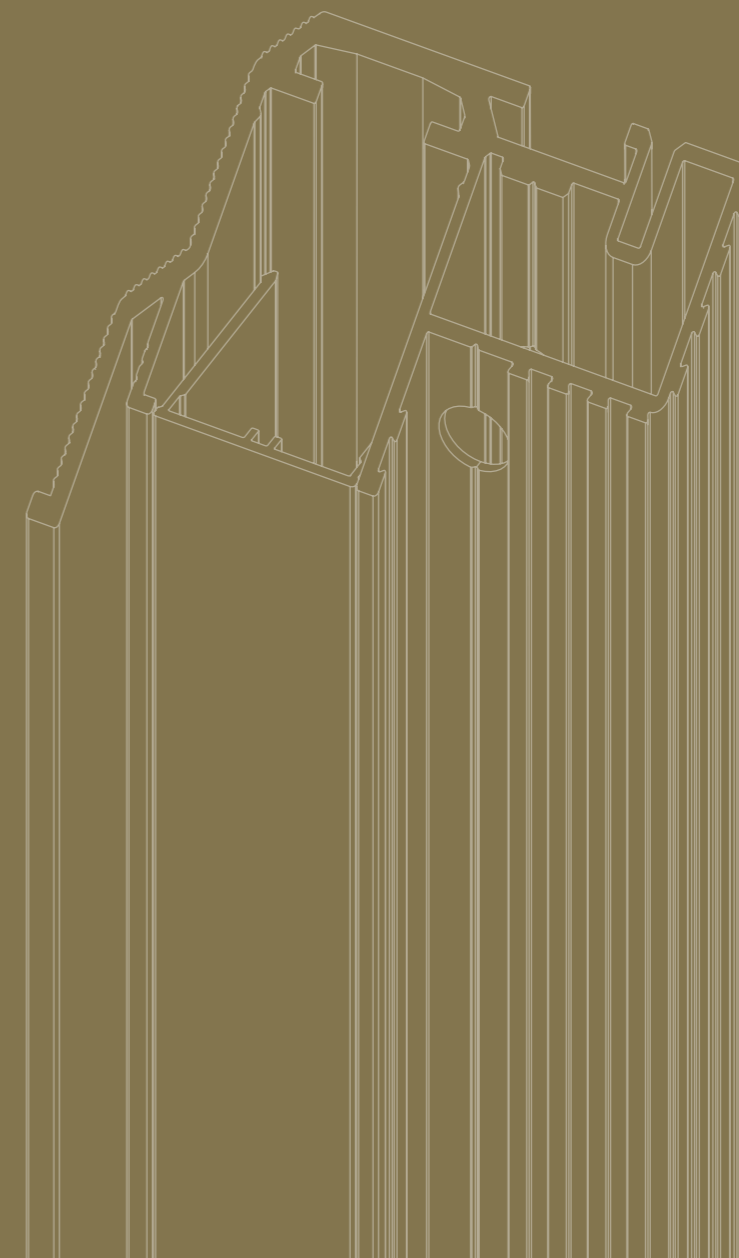



argenta
INVISIDOOR 2.0

Maximum flexibility in invisible doorframes: that's what invisidoor® 2.0 stands for. The doorframe of invisidoor 2.0 consists of a base profile with u-profiling, in which the position of the invisible neo hinges and the lock can be freely selected using various adapters. The base frame for doors rotating to both the left and the right is the same, meaning the rotation direction of the door can still be freely decided even after the frame has been plastered in. Once the position of the adapters has been decided, the remaining space in the u-profile is simply and neatly finished using the cover profile.

argenta invisidoor 2.0

What are the benefits?

Modular

- A single frame for both left and right-hand doors
- Free choice between a left or right-hand door, even after the doorframe has been installed/finished
- Adding an extra hinge or door closer is always possible

Aesthetics

- No visible frame around the door
- Paintable primer coating as standard (powder-coated in any RAL colour upon request)

Efficient installation

- Free installation choice in a milled reveal: before or after plastering (excl. reveals)
- The position of the finger plate and hinges can be adjusted depending on the positioning in the door leaf

Can be applied universally

- For all standard and non-standard door openings (newbuild and renovation)
- For standard flush doors
- For both brick and plasterboard walls

Little chance of cracks in plasterwork thanks to:

- Internal corner joints with permanent access to mitres
- Stable profile
- Strong and easy wall-mounting using screws or window anchors
- Special dovetail profiling for excellent PUR and plaster adhesion

Dimensions

- No difference between custom solutions and standard dimensions
- Top rail (width) and stiles (height) can easily be cut/adjusted to size

Dimensions regarding the door

Dimensions door frame

Width:
 $A = X + 80 \text{ mm}$ (without dowels)
 $A = X + 90 \text{ mm}$ (with dowels)

Height:
 $B = Y + 44 \text{ mm}$

X = DOOR WIDTH
 Y = DOOR HEIGHT
 A = STRUCTURAL OPENING, MIN. WIDTH
 B = STRUCTURAL OPENING, MIN. HEIGHT

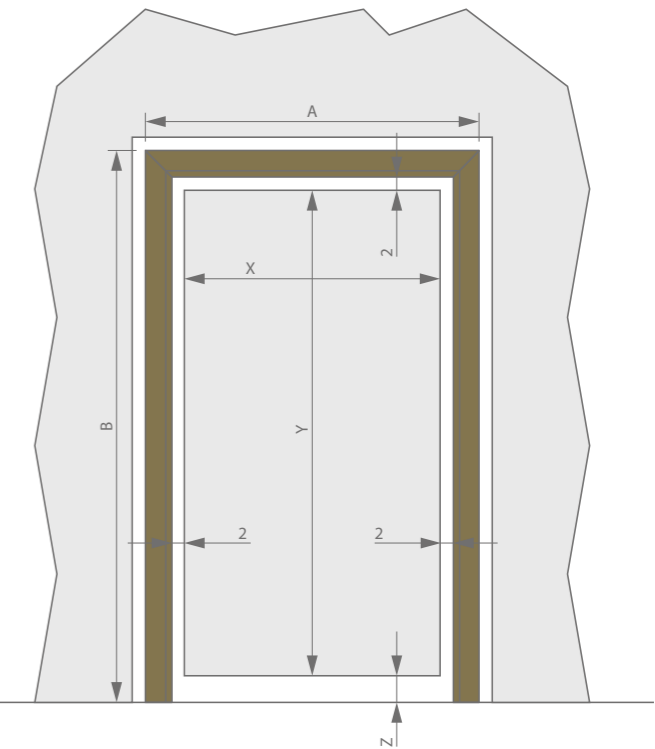

Technical features

	40 mm	44 mm	50 mm	54 mm
Max. door width - single door	1250 mm	1250 mm	1250 mm	1250 mm
Max. door width - double door	2500 mm	2500 mm	2500 mm	2500 mm
Max. door height	4000 mm	4000 mm	4000 mm	4000 mm
door thickness	38 - 40 mm	44 / 45 mm	50 mm	54 mm
Min. wall thickness	75 mm	90 mm	90 mm	90 mm
Fire resistant version (according to EN 1634-1)			EI,30, EI,30, EW30, E30	

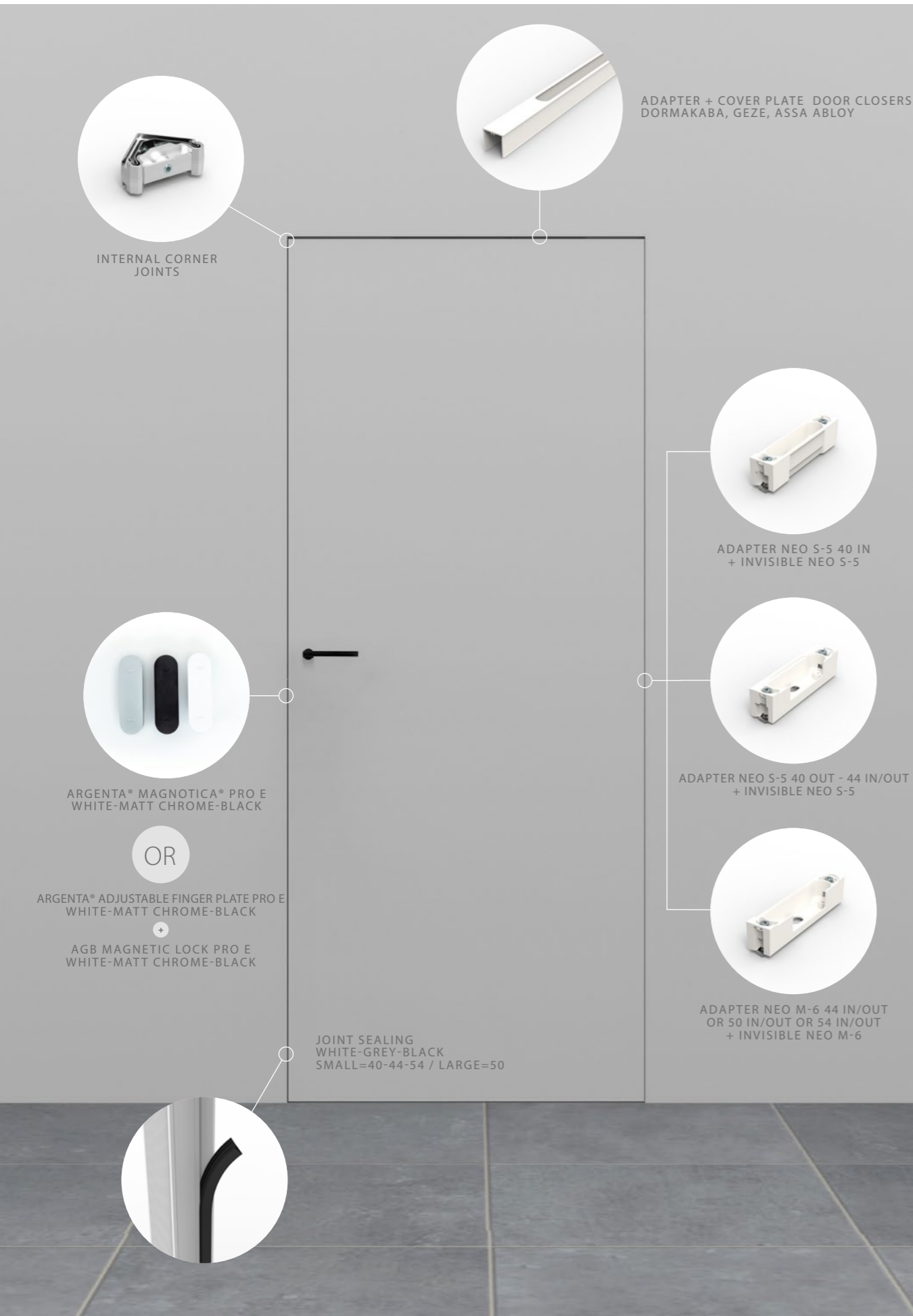

argenta invisidoor 2.0

Adapters and door hardware

Compile your invisidoor® 2.0 from a wide range of door hardware, all with the associated adapters for installation in the base profile.

argenta® invisidoor 2.0		40		44		50		54	
		in	out	in	out	in	out	in	out
Hinges									
Adapter	neo S-5 (in)	epoxy primer	✓						
	neo S-5 (out)	epoxy primer		✓	✓	✓			
	neo M-6 (in / out)	epoxy primer			✓	✓	✓	✓	✓
Hinges	neo S-5	11 finish	✓	✓	✓	✓			
	neo M-6	11 finish			✓	✓	✓	✓	✓
Locks and lock plates		Type	Colour						
			Matt chrome		Black		White		
AGB magnetic lock	Key		✓		✓		✓		
	Cylinder		✓		✓		✓		
	Toilettes		✓		✓		✓		
Lock plate	Adjustable lock plate pro E		✓		✓		✓		
	Electric striking plate Eff-Eff 118TQ13								
KFV magnetic lock	Key		✓		✓		✓		
	Cylinder		✓		✓		✓		
	Toilettes		✓		✓		✓		
Lock plate	Adjustable lock plate KFV		✓		✓		✓		
	Electric striking plate Eff-Eff 118TQ13								
argenta magnetic catch	magnotica® pro E		✓		✓		✓		



argenta
INVISIDOOR

In contrast to traditional interior doors, invisidoor® prioritises contemporary, minimalist architecture and the greatest purity in all aspects. With its hinges and doorframe invisibly concealed, this results in the ultimate solution for sleek interiors. This way, the design of the building can get the attention it deserves, without drowning in technical aspects that often take the aesthetic upper hand.

argenta invisidoor

What are the benefits?

Aesthetics

- no visible frame around the door
- standard equipped with a primer coating (powder coated in all RAL colours on request)

Efficient installation

- option of fitting: before or after plastering
- units are supplied with special hinge caps in the cut-outs for protection during plastering

Can be applied universally

- for all standard and non-standard door openings (new buildings and renovation)
- for standard rebated doors
- for both brickwork and gypsum board walls (metal stud and CLS frames)

Little chance of cracks in plasterwork thanks to:

- sturdy frame construction (integrated corner connection)
- stable profile
- direct, sturdy and easy mounting on walls by using screws or stone anchors
- good adhesion of the plaster work against the profile thanks to the special dovetail profiling

Dimensions

- Large choice in standard dimensions
- doors at room height
- you can easily adjust the upper profile (width) by sawing/adjusting as needed

Dimensions regarding the door

Dimensions door frame

Width:
 $A = X + 64 \text{ mm}$ (without dowels)
 $A = X + 74 \text{ mm}$ (with dowels)

Height:
 $B = Y + 36 \text{ mm}$

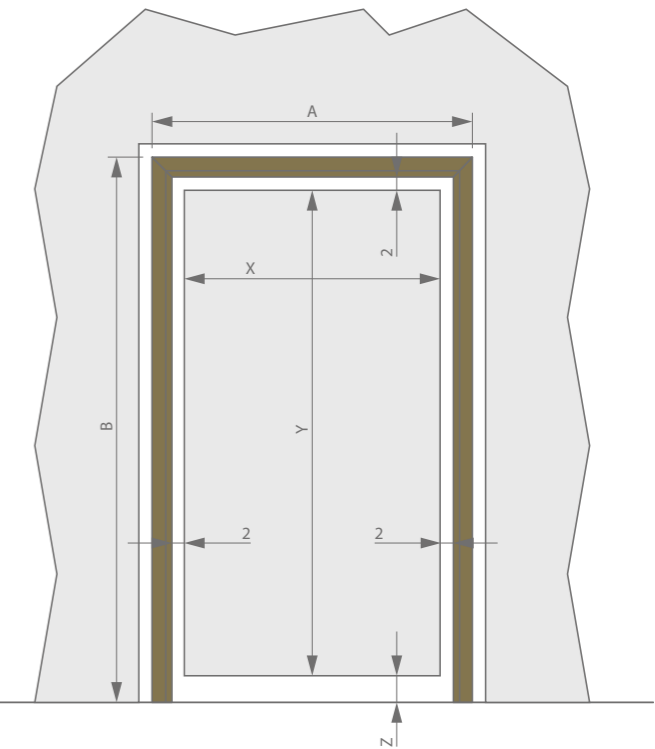

Technical features

	basic	DL 40	DL 44/45	DL 50	DL 54
Max. door width - single door	1250 mm	1250 mm	1250 mm	1250 mm	1250 mm
Max. door width - double door	2500 mm	2500 mm	2500 mm	2500 mm	2500 mm
Max. door height	2500 mm	4000 mm	4000 mm	4000 mm	4000 mm
door thickness	38 - 40 mm	38 - 40 mm	44 / 45 mm	50 mm	54 mm
Min. wall thickness (for brickwork and walls with minimum wall thickness of)	70 mm	70 mm	80 mm	80 mm	80 mm
Fire resistant version (according to EN 1634-1)	EI,30, EI,30, EW30, E30	EI,30, EI,30, EW30, E30	EI,30, EI,30, EW30, E30	EI,30, EI,30, EW30, E30	EI,30, EI,30, EW30, E30



argenta invisidoor — What is included in an argenta invisidoor?

	basic	DL 40	DL 44/45	DL 50	DL 54
Hinges	invisible small	invisible neo S-5 (optional neo M-6)	invisible neo S-5 (optional neo M-6)	invisible neo M-6 (optional neo L-7)	invisible neo M-6 (optional neo L-7)
Integrated seal absorbing door closing impact	Standard: grey	Standard: white On demand: grey or black	Standard: white On demand: grey or black	Standard: white On demand: grey or black	Standard: white On demand: grey or black
Lock	Standard: - AGB Magnetic lock On demand: - AGB Magnetic cylinder lock - AGB magnetic bathroom- and toilet lock - magnotica® pro white, greys or black	Standard: - AGB Magnetic lock Standard: grey On demand: black On demand: - AGB Magnetic cylinder lock - AGB Magnetic bathroom- and toilet lock - Magnotica Pro, magnetic closing system (without lock) - KFV magnetic lock - KFV magnetic cylinder lock - KFV magnetic bathroom- and toilet lock - Litto Multipoint lock type T1781 (only milling) - Smart Entrance, invisible electromagnetic lock - Smart Entrance invisible electromagnetic bathroom and toilet lock - Invisible No-Ha lock - Invisible No-Ha bathroom- and toilet lock	Standard: - AGB Magnetic lock Standard: grey On demand: black On demand: - AGB Magnetic cylinder lock - AGB Magnetic bathroom- and toilet lock - Magnotica Pro, magnetic closing system (without lock) - KFV magnetic lock - KFV magnetic cylinder lock - KFV magnetic bathroom- and toilet lock - Litto Multipoint lock type T1781 (only milling) - Smart Entrance, invisible electromagnetic lock - Smart Entrance invisible electromagnetic bathroom and toilet lock - Invisible No-Ha lock - Invisible No-Ha bathroom- and toilet lock	Standard: - AGB Magnetic lock On demand: - AGB Magnetic cylinder lock - AGB magnetic bathroom- and toilet lock - magnotica® pro white, greys or black	Standard: - AGB Magnetic lock On demand: - AGB Magnetic cylinder lock - AGB magnetic bathroom- and toilet lock - magnotica® pro white, greys or black
Doorcloser	/	Doorcloser: - Dorma ITS 96 2-4 - Geze boxer 2-4 - Geze Activestop	Doorcloser: - Dorma ITS 96 2-4 - Geze boxer 2-4 - Geze Activestop	Doorcloser: - Dorma ITS 96 2-4 - Geze boxer 2-4 - Geze Activestop	Doorcloser: - Dorma ITS 96 2-4 - Geze boxer 2-4 - Geze Activestop
Finishing	Standard equipped with a primer coating (powder coated in all RAL colours on request)				

Invisible hinges

When choosing an argenta® invisible neo hinge in combination with an argenta invisidoor® DL it is important to keep the door weight in mind and the desired color.

	invisible small	invisible neo S-5	invisible neo M-6	invisible neo L-7
Finishing	matt chrome, tar black, white	Matt chrome, Glossy chrome, Stainless steel look, Tar black, Black umber, Bronze, Dark bronze, Classic bronze, Polished brass (CU), Copper**		
Door weight (2 pc) up to*	40 kg	60 kg	80 kg	100 kg
Door weight (3 pc) up to*	50 kg	80 kg	100 kg	150 kg
Technical characteristics	3D adjustable (height, depth, and pressure)	3D adjustable (height, depth, and pressure) No visible screws Easy-Hook, installation and 3D adjustable by one person Height adjustment without wedge Pure and qualitative design		

* Based on a reference door of 1000 x 2000 mm
** See page 43



02

PIVOT DOORS

Also for pivot doors, ARLU® offers the perfect solution based on its invisidoor® technology. The result is a fully invisible doorframe and base that allows doors to swing open in both directions, once again with minimalism and sleek design as a fundamental feature.

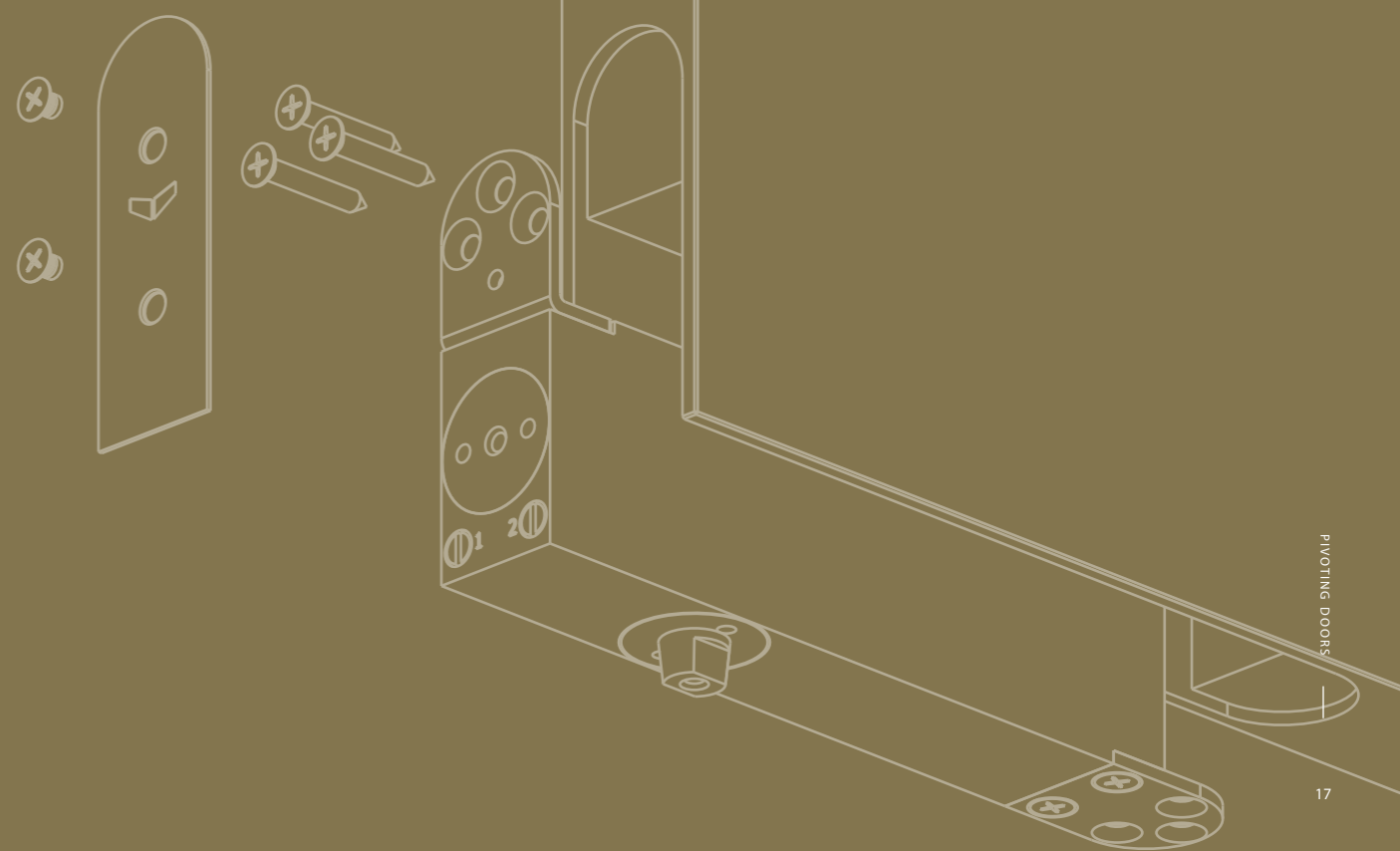



argenta
INVISIDOOR AX
FOR INTERIOR PIVOT DOORS
UP TO 45 KG

Argenta® invisidoor® AX is an invisible aluminium frame for interior pivot doors that can easily, quickly and invisibly be installed and plastered. This innovative concept makes installing of a pivot door like a child's play; fitting the frame with its integrated pivot system is extremely easy, and no built-in floor system is required. Argenta invisidoor AX is the perfect solution for a dressing room door or a door between a kitchen and living room, as it can easily and quickly be pushed open, in both directions, without a door handle.

argenta
INVISIDOOR AX PRO
FOR INTERIOR PIVOT DOORS
UP TO 100 KG

Argenta® invisidoor® AX pro is an invisible aluminium frame for interior pivot doors up to 100 kg that is ideal for heavier and more frequently used solutions. As the pivot system is integrated into the door leaf, argenta invisidoor AX Pro can be used in both newbuild and renovation projects, presenting the ideal solution for floors with under-floor heating in both circumstances. The door can be opened in both directions and has a hold position at 90°. Thanks to an active closure damper, the door always returns to its zero position. This keeps the door perfectly flush with the wall, ensuring there are no interruptions with the sleek design of the wall. Argenta invisidoor AX Pro without hold-open complies with the requirements of the EN 1154 standard for door closers.



argenta invisidoor AX / AX pro

What are the benefits?

Aesthetics

- no visible frame around the door
- easy and hidden door assembly due to patented upper pivot system.
- virtually invisible pivot system
- generally supplied with paintable primer (other colours on request)

Efficient installation

- quick and effortless installation of the door and the frame
- the door position doesn't need to be adjusted
- for brickwork and walls with minimum wall thickness of 70 mm

Can be applied universally

- for all standard and non-standard door openings (new buildings and renovation)
- for both brickwork and gypsum board walls (metal stud and CLS frames)

Little chance of cracks in plasterwork thanks to:

- sturdy frame construction (integrated corner connection)
- stable profile
- direct, sturdy and easy mounting on the walls by using screws or stone anchors
- good adhesion of the plaster work against the profile thanks to the special dovetail profiling

Dimensions

- wide range of dimensions
- doors at room height
- customized dimensions



Dimensions regarding the door

Dimensions door frame AX

Width: $A = X + 70$ mm (without dowels)
 $A = X + 80$ mm (with dowels)
 Height: $B = Y + 39$ mm

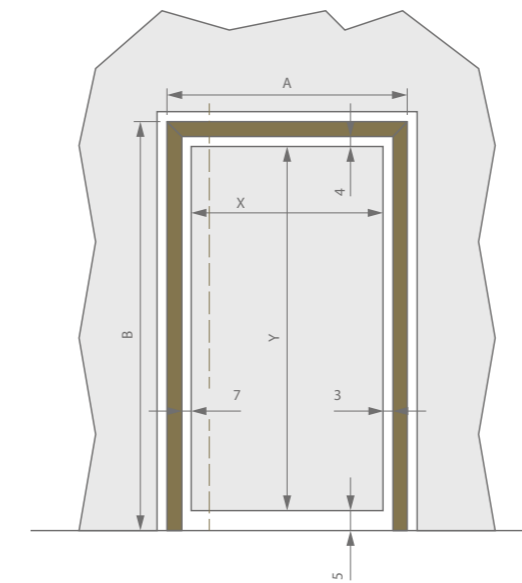

Dimensions door frame AX pro

Width: $A = X + 69$ mm (without dowels)
 $A = X + 79$ mm (with dowels)
 Height: $B = Y + 47$ mm

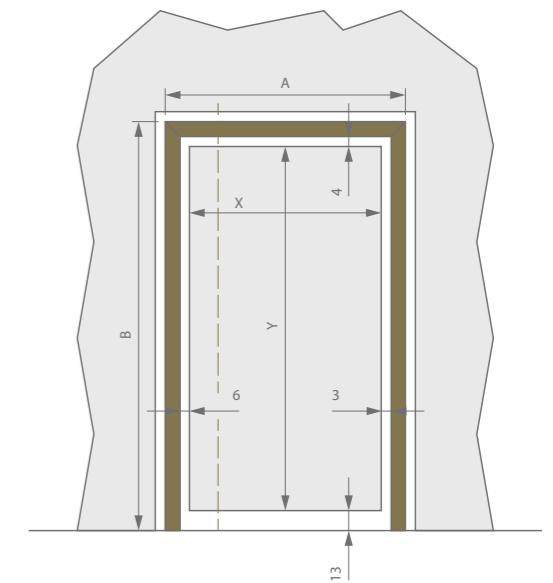

Technical features

	AX	AX pro
Max. door weight	45 kg	100 kg
Max. door width	1000 mm	1000 mm
Max. door height	3000 mm	3000 mm
Min. door thickness	38 - 40 mm	40 mm

What is included in an invisidoor AX / AX pro?

	AX	AX pro
Pivoting door system	argenta® pivotica®	pivotica® pro 100 F90
Lock	Standard: magnotica®, magnetic closing system	Standard: without lock Option: magnotica®pro (grey, black or white)
EPB norm (BE)	Only through additional floor plate (clearance of 5 mm up to 9 mm)	Meets standard (13 mm clearance between the floor and the door)
EN1154	-	Meets the EN1154 standard



03

POCKET DOORS

Sliding door systems are the perfect solution when space saving is a must. As the door leaf slides into the wall, no space is lost compared to the opening angle of a swing or pivot door. Argenta®'s sliding door systems, which are based on the invisidoor® concept, allow you to enjoy timeless and minimal design for both glass and wood interior doors.

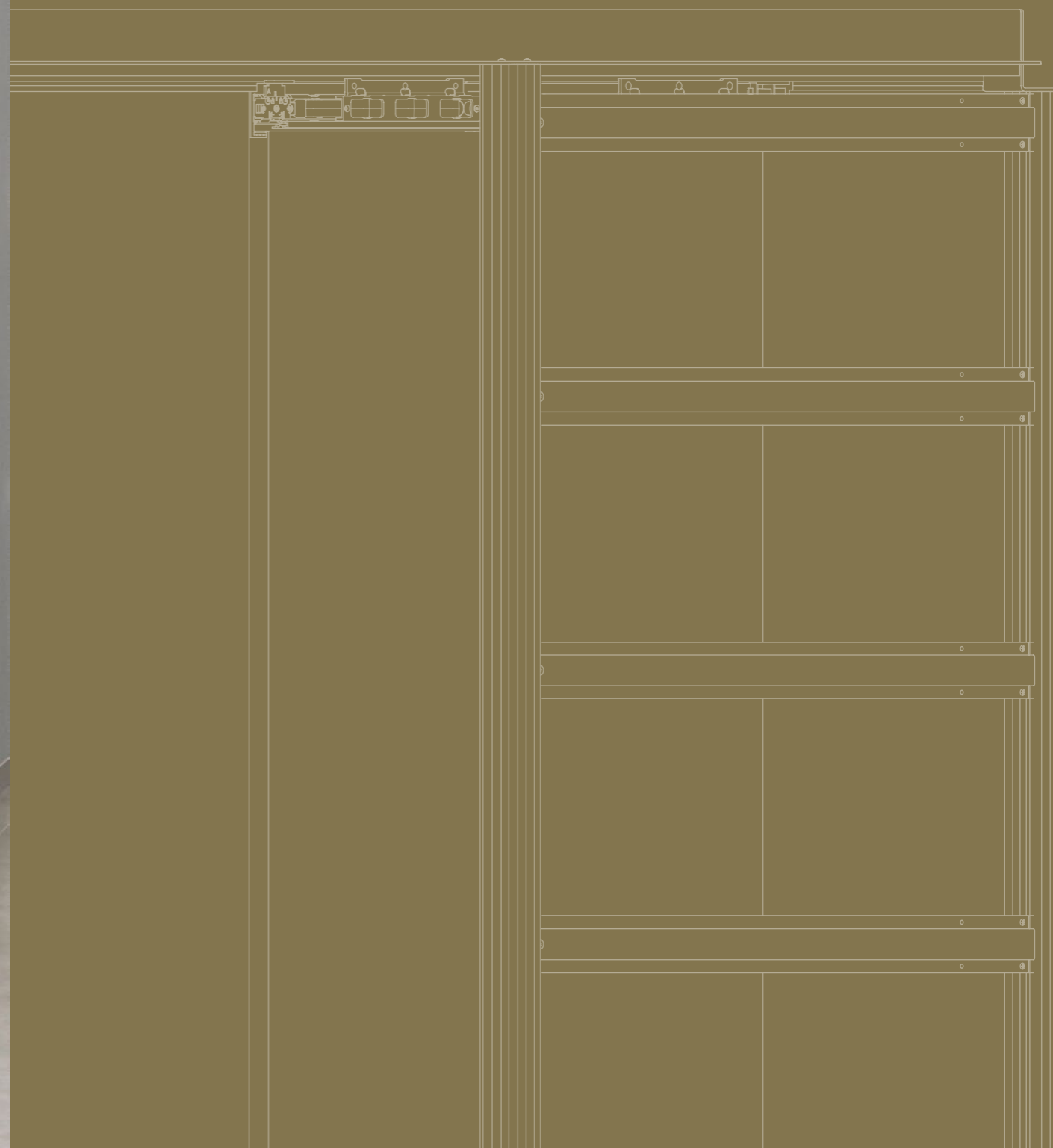



argenta
INVISIDOOOR S
FOR FLUSH POCKET DOORS

Invisidoor® S is a sliding door that disappears into the wall when opened, and sits perfectly flush when closed. It is the ultimate combination of the best of invisidoor DL and invisidoor SDX: the harmonious character of an invisible doorframe for pivot doors paired with the practical space-saving properties of a pocket door. The unique door hardware not only guarantees optimal and diagonal guidance for the door leaf; it also remains accessible at all times for height adjustment and to remove the door leaf if necessary. Ergonomics and top architecture combined, in other words, with the door leaf disappearing completely into the wall.



argenta invisidoor S

Invisidoor® S thus represents a minimalist sliding door integrated into the wall, both when open and closed! This beautiful finish is also combined with a sublime operation. The refined finish of this door system does not stand in the way of its perfect operation: Invisidoor S is equipped as standard with a softclose system to close the door softly and independently. The product has also been designed in such a way that the door leaf remains easily adjustable. Even when everything is finished, the rollers, softclose, and auto-eject can always be disassembled without damaging the wall.



What are the benefits?

Aesthetics

- When closed, the door melds seamlessly into the wall.
- 100% free passage because the door slides into the wall completely
- no visible frame around the door
- paintable primer coating as standard
- opening in wall is closed by a moving cover profile
- door closes softly and independently and is finally 'trapped' in a TPE seal
- an auto-eject is a pleasant way to hide the door away and still make it accessible

Efficient installation

- finishing with double plasterboard panels is possible (only with a wall thickness of 125 mm)

Can be applied universally

- the back of the wall can be adapted to any wall thickness.

Little chance of cracks in plasterwork thanks to:

- solid construction framework (integrated corner connection)
- stable profile
- solid and easy wall mounting using screws
- special dovetail profiling for good PUR and plaster adhesion

Dimensions regarding the door

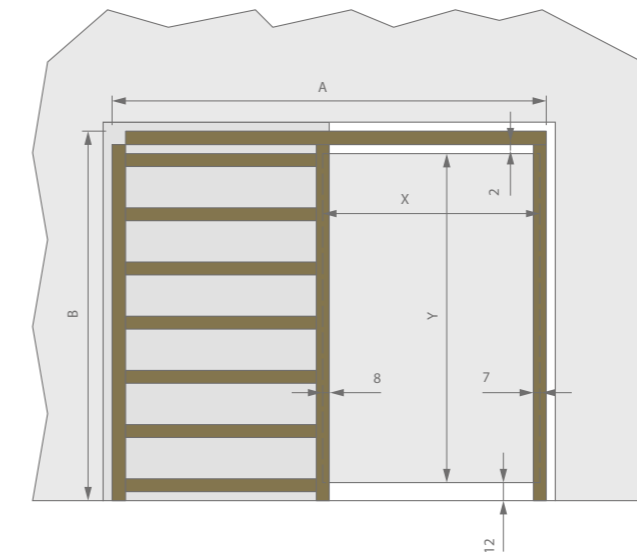

Setup

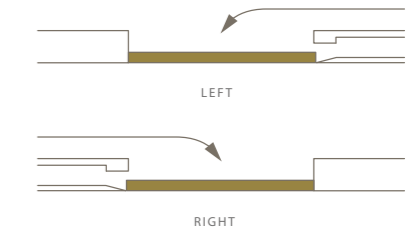

Technical features

	invisidoor® S
Standard door widths	830 - 930 - 1030 mm
Standard door heights	2015 - 2040 - 2115 - 2140 - 2315 - 2600 mm
Door thickness	40 mm
Door weight	80 kg
Min. wall thickness (both masonry and walls with minimum thickness of)	125 mm

Minimum recessed dimensions

W = (width of door panel x 2) + 190 mm
H = height of door panel + 126 mm

Colours

Running profile: black anodisation
Post profiles at the door opening: white primer
Cover profile at the top of the door: white primer
Cover profile at the bottom of the door: white primer

What is included in an invisidoor S?

	invisidoor® S
Frame	Aluminium frame with a running profile and steel reinforcement profiles
Even system	Scissor system combined with trolleys and a guiding system
Cover profiles	Cover profiles to close the back of a scissor system, the guiding system, and the opening in the wall
Sliding door fitting sets	Softclose damper Auto-eject White integrated impact seal White magnetica® Pro Hook lock
Finish	Made as standard with a primer that can be painted over



argenta invisidoor S

S-handle

The argenta® S-handle is an invisible flush mounted door handle. It has been specifically designed to integrate into the invisidoor® S- range and suitable for 40mm blanks. It's position can be chosen freely and it comes in 3 finishes; primed, black anodised, and F1 brushed. The S-handle is applicable as a single or a double handle. We advise to combine it with 1 or more magnotica® pro E magnetic catches.

Technical drawing

double handle

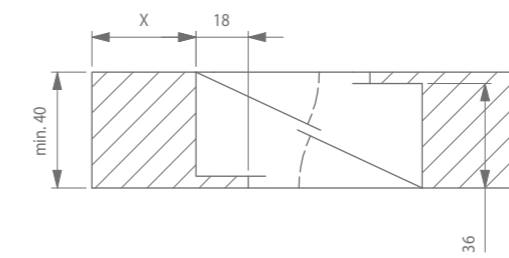

single handle

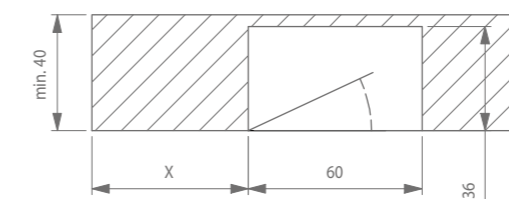
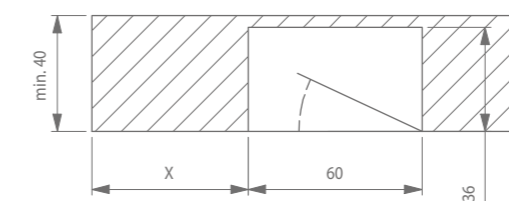

white primed



F1 brushed



black anodised



argenta
INVISIDOOR SDX
COMPLETE SOLUTION FOR
POCKET DOORS

Argenta® invisidoor® SDX is a complete solution with an invisible aluminium frame for interior doors that slide into the wall, which enables you to extend the sleek design of the invisidoor range to your sliding doors in both timber and glass. Now that argenta invisidoor SDX is also available for timber sliding doors in a corner setup, a whole new world of interior design possibilities is opened up. In both assisted-living facilities or lofts, separating small spaces without having to lose any sense of spaciousness is where the skill lies. Interior doors up to 100 kg can easily be removed thanks to Manual or Auto Fix, and the removable top profile ensures the same applies to all doorstops and closers.

argenta invisidoor SDX

What are the benefits?

Aesthetics

- 100% free passage because the door completely slides into the wall
- no visible frame around the door
- standard equipped with a primer coating (powder coated in all RAL colors on request)
- minimum spacing of 5 mm between the top of the door panel and the frame

Efficient installation

- installation of frame and door at the same time
- can be finished with double plasterboard (only for a wall thickness of 125 mm)

Can be applied universally

- can be used for door thicknesses of 38 to 45 mm
- can be used with any type of hook lock

Little chance of cracks in plasterwork thanks to:

- sturdy frame construction (integrated corner connection)
- stable profile
- direct, sturdy and easy mounting on walls using screws or stone anchors
- good adhesion of the plaster work against the profile thanks to special dovetail profiling

Dimensions

- wide range of dimensions
- made-to-measure

Technical features

	SDX 100	SDX 125
Max. wall thickness	100 mm	125 mm
Max. door height	2140 mm	3000 mm
Max. door weight	100 kg	100 kg
Max. door width	Depending on the door height*	
door thickness	38 - 45 mm	38 - 45 mm

* Ask our calculation table for more information

Minimum built-in dimensions

type SDX
 W = (width doorpanel x 2) + 17 mm
 H = height doorpanel + 65 mm

Dimensions regarding the door

invisidoor® SDX - without lock profile

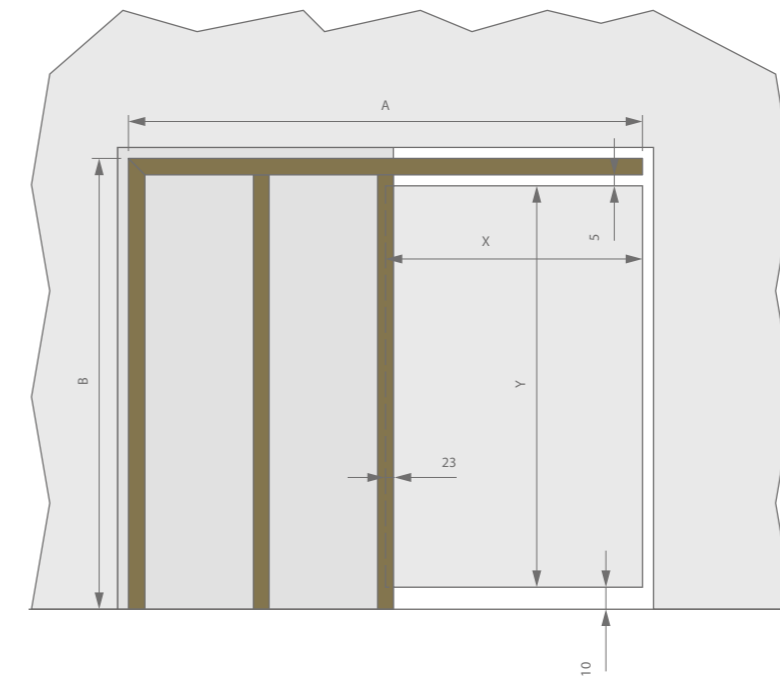

X = DOOR WIDTH
 Y = DOOR HEIGHT
 A = STRUCTURAL OPENING, MIN. WIDTH
 B = STRUCTURAL OPENING, MIN. HEIGHT
 V = FREE PASSAGE WIDTH
 W = FREE PASSAGE HEIGHT

Width: $A = (X + X) - 5 \text{ mm}$
 Height: $B = Y + 65 \text{ mm}$
 $V = X - 23 \text{ mm}$
 $W = Y + 15 \text{ mm}$

invisidoor® SDX - with lock profile

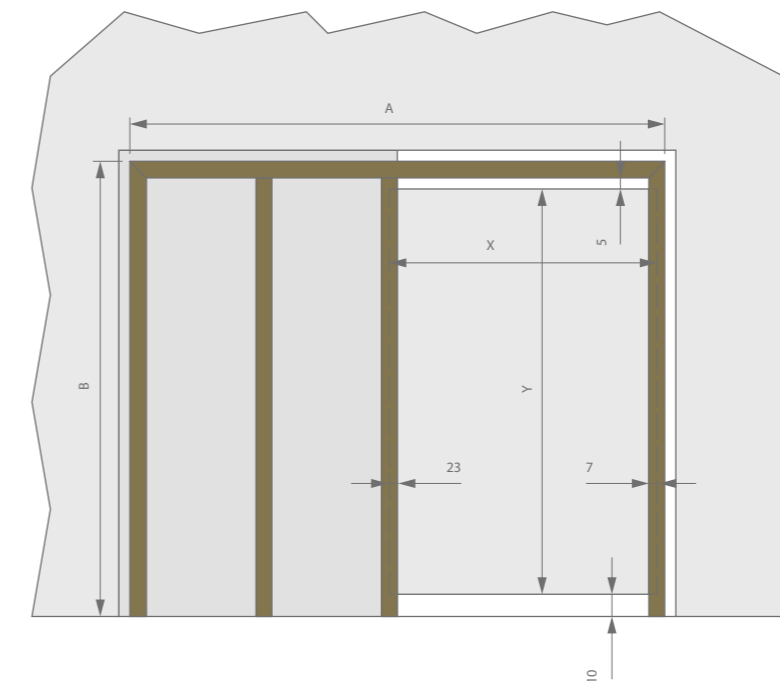

X = DOOR WIDTH
 Y = DOOR HEIGHT
 A = STRUCTURAL OPENING, MIN. WIDTH
 B = STRUCTURAL OPENING, MIN. HEIGHT
 V = FREE PASSAGE WIDTH
 W = FREE PASSAGE HEIGHT

Width: $A = (X + X) + 17 \text{ mm}$
 Height: $B = Y + 65 \text{ mm}$
 $V = X - 30 \text{ mm}$
 $W = Y + 15 \text{ mm}$



argenta invisidoor SDX — What is included in an invisidoor SDX?

	SDX
Frame	Standard invisidoor® frame
Sliding door hardware	<ul style="list-style-type: none"> - Removable argenta® proslide® upper profile - 3 connecting brackets - 2 intermediate profiles* - Unique connecting profile
Sliding door fitting sets	<ul style="list-style-type: none"> - Argenta proslide manual-fix fixing system - One slow stop damper and one adjustable stop - Integrated floor guide - Removable, acoustic TPE seal
Lockprofiel	Applicable with or without lock profile
Finish	Finished with an epoxy primer, making it easy to paint the frame
Options	<p>Standard:</p> <ul style="list-style-type: none"> - Coverplate <p>On demand:</p> <ul style="list-style-type: none"> - Magnetic closing system magnetica® pro - Lock plate for hook locks - No milling - Argenta proslide auto-fix fixing system - 2 single slow stop damper or 1 double slow stop damper - Reinforced floor's profile
Accessories	<ul style="list-style-type: none"> - Brush seal - Floor guide for the door - Recessed door profile for easy fixing of the manual- or auto-fix - Design handle by argenta - Snap-on cover profile - Selfclose - Push & Go

* Depending on the wall thickness, we advice you to install extra intermediate profiles



argenta invisidoor SDX - Corner

Technical features

	SDX Corner
Max. wall thickness	125 mm
Max. door height	3000 mm
Max. door weight	100 kg (per deur)
Max. door width	1500 mm
Door thickness	38 - 45 mm

Minimum recessed dimensions

Door A recessed length: B = (width of door panel x 2) + 31 mm
 Door A recessed height: H = door panel height + 65 mm
 Door B recessed length: B = (width of door panel x 2) + 31 mm
 Door B recessed height: H = door panel height + 65 mm

Free passage

Free passage = $\sqrt{((\text{door leaf A}-30)^2+(\text{door leaf B}+10)^2)}$
 In case door leaf A is in front of door leaf B.

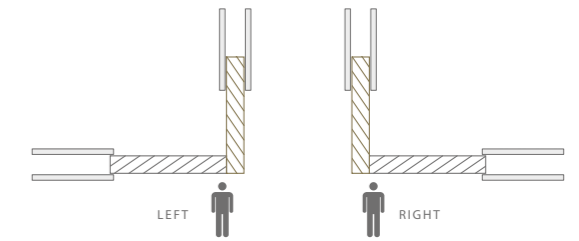

What is included in an invisidoor SDX Corner?

	SDX Corner
Frame	Invisidoor® SDX door frame in corner set-up
Sliding door hardware	<ul style="list-style-type: none"> - Removable argenta® proslide® top profile - 5 connector brackets - 2 end profiles - Unique connector profile
Sliding door fitting sets	<ul style="list-style-type: none"> - Argenta proslide manual-fix mounting - One slow stop shock absorber and one adjustable stop - Integrated base plate - Removable, acoustic TPE seals
Finish	Supplied with primer that can be painted over as standard
Options	<p>Standard:</p> <ul style="list-style-type: none"> - Cover plate <p>Upon request:</p> <ul style="list-style-type: none"> - 'Magnotica®' magnetic closing system - Lock plate for hook lock - No milling - Argenta proslide auto-fix fixing system - 2 single slow stop or 1 single slow stop Small - Reinforced floor's profile
Accessories	<ul style="list-style-type: none"> - Sealing brushes - Bottom guide profile for the door - Recessed door profile for simple mounting of the manual-fix or auto-fix - Designer door handle - Click-on cover profile - Push & Go - Reinforced floor's profile



argenta invisidoor SDX - Glass

Technical features

	SDX Glass
Max. wall thickness	125 mm
Max. glass panel height	3000 mm
Max. glass panel weight	100 kg
Max. glass panel width	Depends on the door height and door weight*
Glass thickness	8 mm, 10 mm or 12 mm

Minimum recessed dimensions

type SDX Glass

Recessed length: B = (width of glass panel x 2) + 17 mm

Recessed height: H = height of glass panel + 91 mm

Slow stops**

min. door width for a single slow stop = 730 mm

min. door width for a single slow stop Small = 950 mm

min. door width for two slow stops = 1030 mm

What is included in an invisidoor SDX Glass?

	SDX Glass
Frame	Standard invisidoor® SDX door frame
Sliding door hardware	<ul style="list-style-type: none"> - Removable argenta® proslide top profile - 3 connector brackets - 2 split profiles - Unique connector profile
Sliding door fitting sets	<ul style="list-style-type: none"> - Argenta Proslide Glass-Fix mounting with two glass clamps based on the glass thickness - One single slow stop and one standard stop* - Integrated base plate - Removable, acoustic TPE seals
Finish	Supplied with primer that can be painted over as standard
Options	2 single slow stops or 1 single slow stop small
Accessories	<ul style="list-style-type: none"> - Rubber seals - Sliding cover profile with end cap

* Ask our calculation table for more information

** Argent Alu advises, if the panel width is wide enough, to switch the accessories to 2 Single Slow-stops or 1 single slow stop Small



04

INVISIBLE SKIRTING BOARDS

Doorframes, casings and hinges no longer present an obstacle thanks to invisidoor® frames. However, one final visual hurdle prevented the invisidoor concept from fully blending into the subtle interplay of lines it deserves to be part of: traditional surface-mounted skirting disturbed the harmonious balance of an invisible doorframe. Argenta®'s invisiplint presents a much-needed solution to this by contributing to the visual purity of any interior.

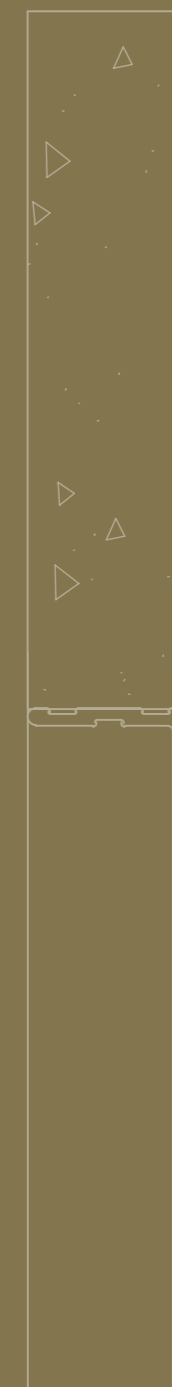



argenta
INVISIPLINT

Our invisiplint invisible skirting is available in flush-mounted or recessed versions, both with the same sleek and minimal result you are looking for. This system ensures walls and floors seamlessly blending into one another, without compromising on the functionality of skirting boards. Just like traditional skirtings, invisiplint protects your walls from being damaged and allows the necessary space for expanding floor coverings.



argenta invisiplint

What are the benefits ?

Aesthetics

- virtually invisible skirting boards
- generally supplied with paintable primer (other colours on request)
- can perfectly be combined with the invisidoor® range to give an entire room the minimalistic look and feel that you strive for

Can be applied universally

- when used with the invisidoor type OUT, the door with the invisiplint can be opened up to 180°, something that is not possible with a classic skirting board.
- when used with the invisidoor type IN, it is impossible to use a classic skirting board. But with the invisiplint this no longer forms an issue and there is also no risk of bumping the door up to concealed skirting board.

	Thin adhesive skirting board (type 1)	Recessed skirting board drylining (type 2)	Recessed skirting board brick wall (type 3)
Max. length*	3000 mm	3000 mm	3000 mm
Accessories	No Accessories	For connection with invisidoor: - End piece, inner and outer conner for invisidoor DL40 - End piece, inner and outer conner for invisidoor DL44/45 - End piece, inner and outer conner for invisidoor DL50	

* = The skirting boards can be sawn to size by yourself



Thin adhesive skirting board (type 1)



Recessed skirting board (type 2)



Recessed skirting board brick wall (type 3) with finishing skirting board in the same material as the floor

GENERAL INFORMATION

NOTES

Type of door

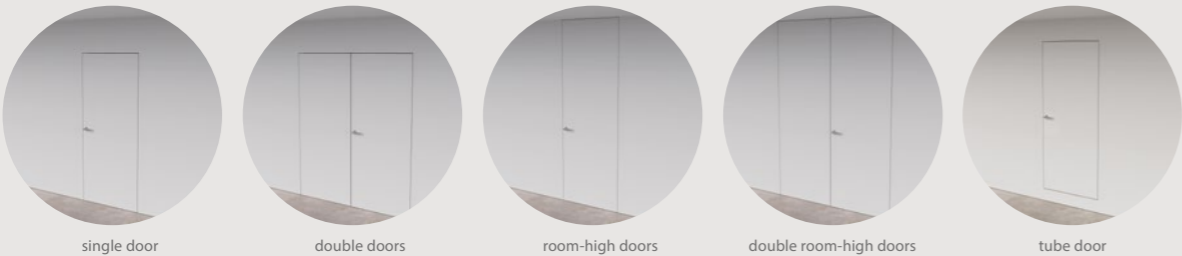

IN or OUT and LEFT or RIGHT

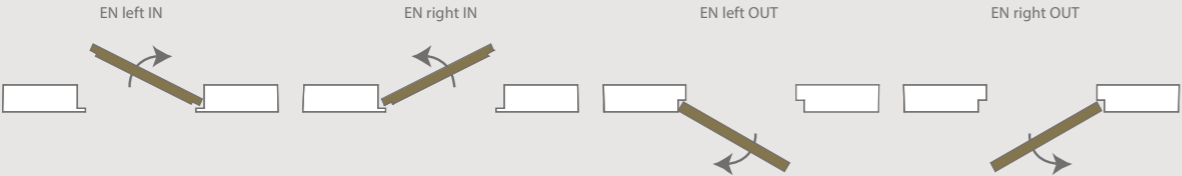

invisible neo finishes

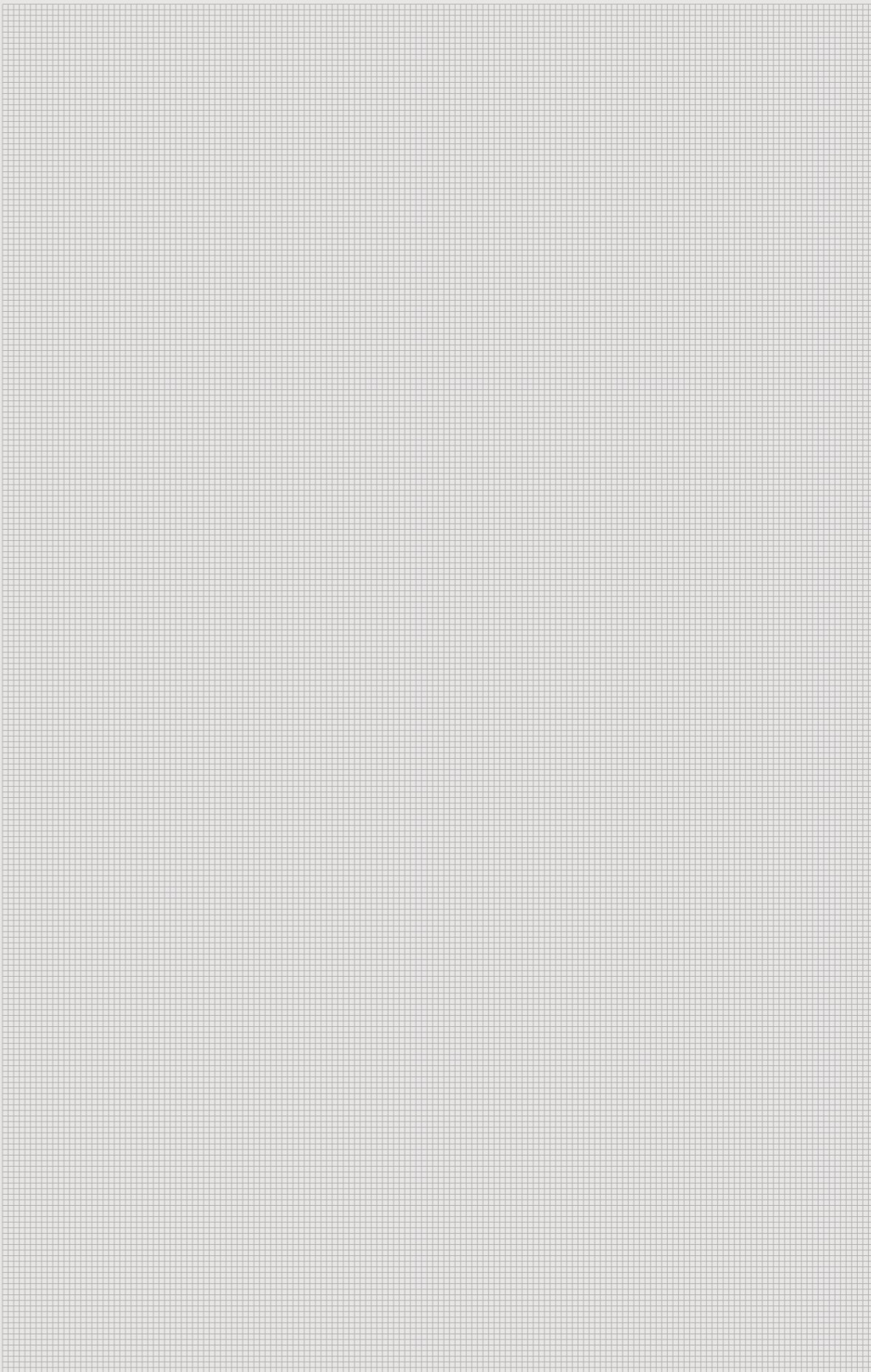
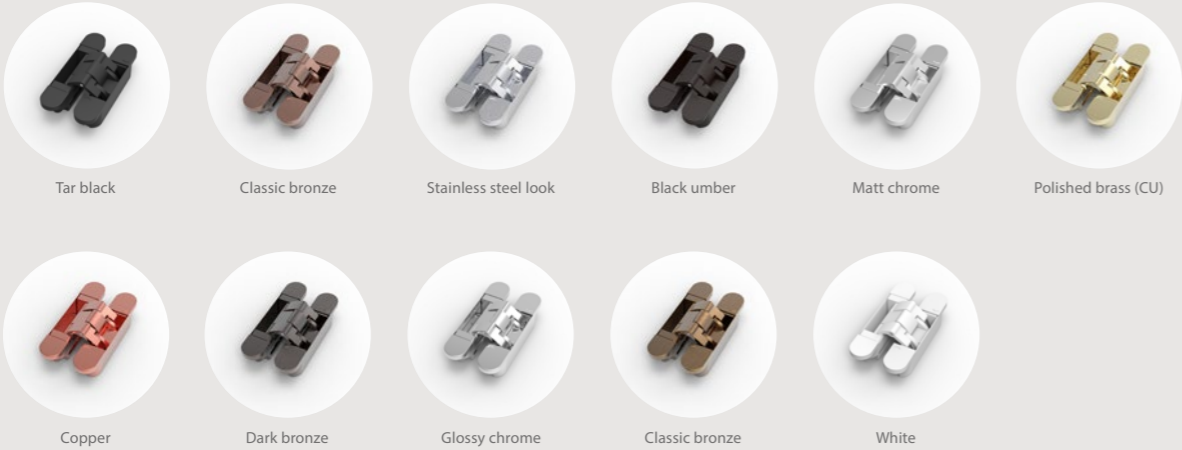



Ter Vlucht 2 +32 (0)51 27 05 00
8850 Ardoonie info@arlu.be
Belgium WWW.ARLU.BE

