



EXPERT

GLASS



 **argenta**
OPENING DOORS



- 01** PUNCH
- 4 fixed glass wall with ceiling mount
 - 8 ceiling mount
 - 12 ceiling mount total sets
 - 14 wall mount
 - 18 wall mount total sets

- 02** EXPERT GLASS
- 24 expert 40 kg
 - 28 expert 80 kg
 - 32 expert 80 kg superior
 - 36 expert 120 kg

- 03** CUBE GLASS
- 42 cube 40 - 80 kg

- 04** CUBE CRYSTAL GLASS
- 48 cube crystal 80 - 120 kg

- 05** LATENT GLASS
- 54 latent 80 - 120 kg

- 06** HIDE GLASS
- 62 hide 80 - 120 kg

- 07** SYMMETRICAL GLASS
- 68 symmetrical 80 kg

- 08** TELESCOPIC GLASS
- 74 telescopic 80 kg

- 09** PRODUCT CONFIGURATOR

ARLU, THE REFERENCE FOR OPENING DOORS

ARLU® is the manufacturer behind the brand names argenta® and rob®. Argenta has been a leading brand in door hardware for over 100 years, but today it is mainly synonymous with invisible door systems.

Minimalist architecture swears by clean lines and a "back to the essence" mentality. In terms of interior doors, this results in integrated door fittings, invisible integrated techniques, door frames and skirting boards for revolving, sliding and pivoting doors.

Argenta stands for a full range of sleek interior solutions.

01

PUNCH

Punch® stands for minimalist glass fittings. This ultra-fine integrated sliding system is especially designed for glass sliding doors up to 150 kg, sliding in front of a fixed glass partition. Fully integrated clamps give the glass door a sleek finish, so that only the glass is visible.

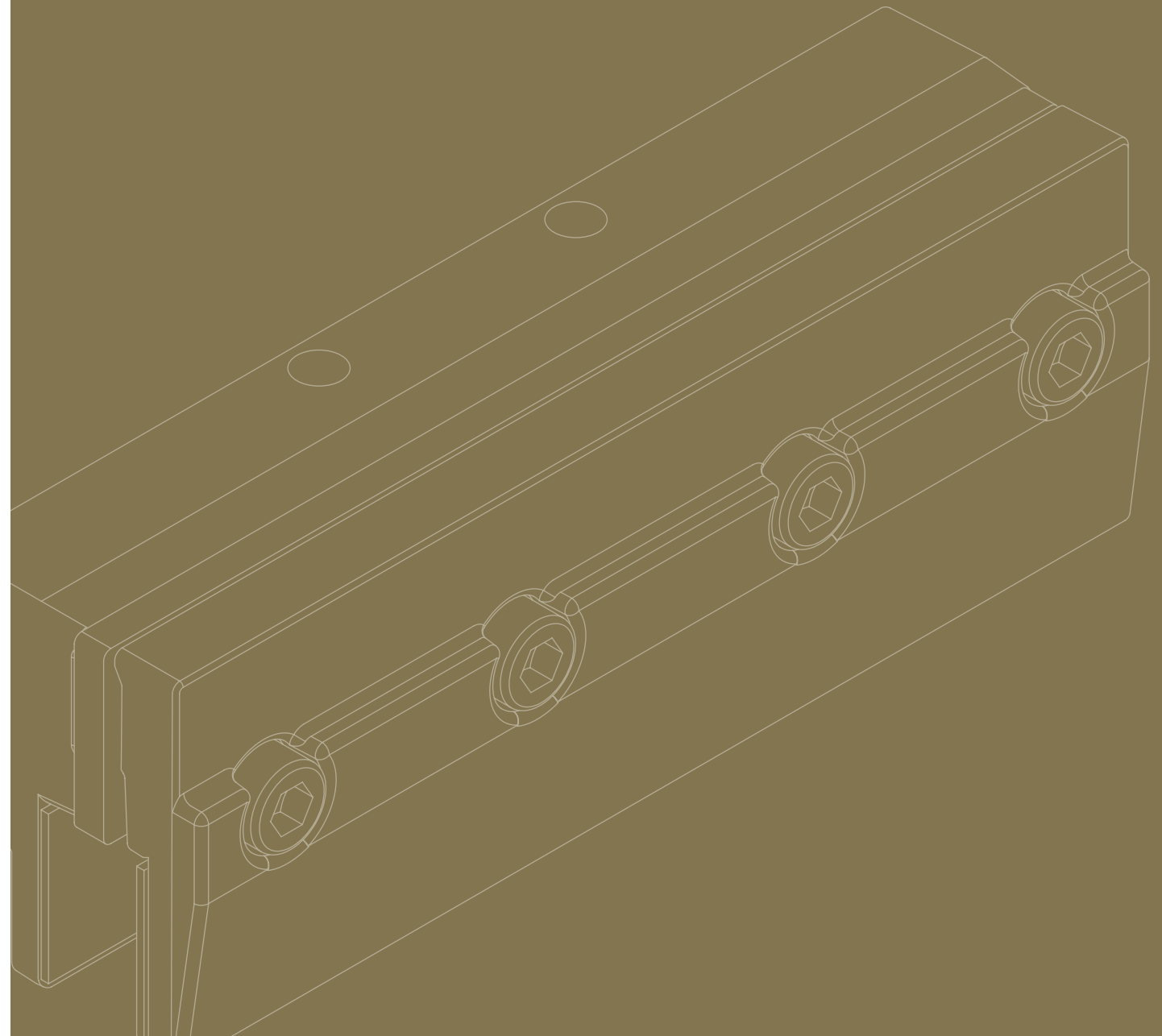



argenta
PUNCH
 WITH FIXED GLASS PARTITION,
 CEILING MOUNT

Punch® stands for minimalist glass fittings that set the leading standard in any interior. This ultra-fine integrated sliding system is especially designed for glass sliding doors up to 150 kg, sliding in front of a fixed glass partition. In this setup, one single, sleek profile holds both the fixed and sliding parts in place. The glass partition is fixed at the bottom by means of a U-profile and nicely finished with its covers. Fully integrated clamps provide a sleek finish to the glass door so that only the glass is visible. In this arrangement, the profile is always fixed under the ceiling or built into the suspended ceiling. In combination with a soft close system, punch provides extra convenience. All parts remain accessible at all times, meaning they can be disassembled quickly without causing any damage. This also means that it is possible to hang the glass panel after the ceiling has been completely finished. All tracks are available in three finishes : grey anodised aluminium, stainless steel look or black anodised aluminium.

PROFILE LENGTH

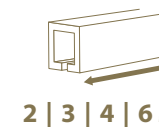

INSTALLATION



DOOR THICKNESS



DOOR WEIGHT



anodised
aluminium

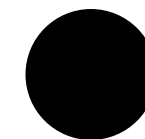

black anodised
aluminium



Stainless steel
look

Technical drawing

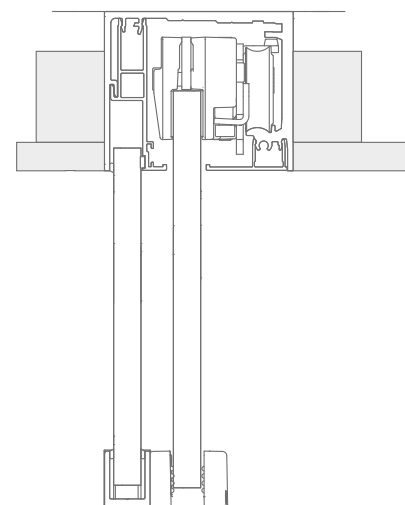
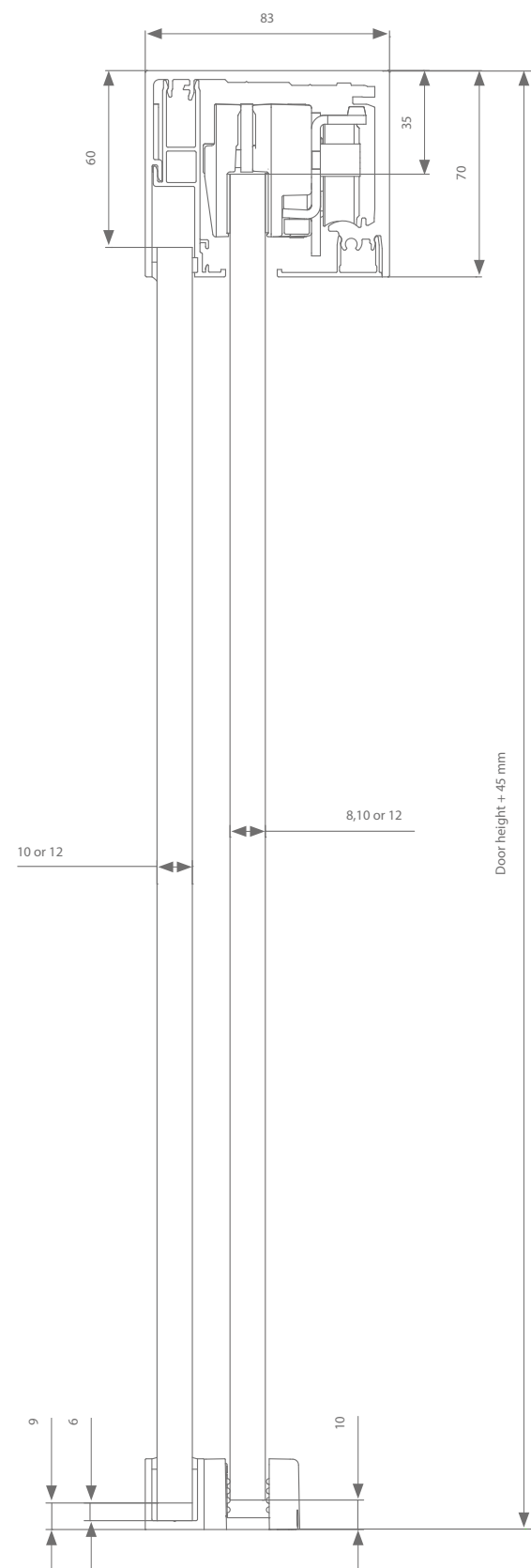

*The glass used must always be hardened and meet safety standard EN 12150

Tracks, profiles & covers

Black anodised aluminium	Min. door width	Length	Reference
Set of tracks	1000 mm	2000 mm	PN0.250.200.2
	1500 mm	3000 mm	PN0.250.300.2
	2000 mm	4000 mm	PN0.250.400.2
	3000 mm	6000 mm	PN0.250.600.2

Set of covers			PN9.258.12
---------------	--	--	------------

Set of floor track covers			PN9.308.12
---------------------------	--	--	------------

Optional: U-profile to fix glass partition vertically as well		3000 mm	PN0.308.300.2
		6000 mm	PN0.308.600.2

Grey anodised aluminium	Min. door width	Length	Reference
Set of tracks	1000 mm	2000 mm	PN0.250.200.0
	1500 mm	3000 mm	PN0.250.300.0
	2000 mm	4000 mm	PN0.250.400.0
	3000 mm	6000 mm	PN0.250.600.0

Set of covers			PN9.258.17
---------------	--	--	------------

Set of floor track covers			PN9.308.17
---------------------------	--	--	------------

Optional: U-profile to fix glass partition vertically as well		3000 mm	PN0.308.300.0
		6000 mm	PN0.308.600.0

Anodised aluminium with stainless steel look	Min. door width	Length	Reference
Set of tracks	1000 mm	2000 mm	PN0.250.200.7
	1500 mm	3000 mm	PN0.250.300.7
	2000 mm	4000 mm	PN0.250.400.7
	3000 mm	6000 mm	PN0.250.600.7

Set of covers			PN9.258.17
---------------	--	--	------------

Set of floor track covers			PN9.308.17
---------------------------	--	--	------------

Optional: U-profile to fix glass partition vertically as well		3000 mm	PN0.308.300.7
		6000 mm	PN0.308.600.7

Fitting Selection

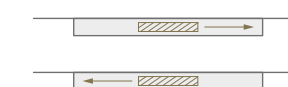
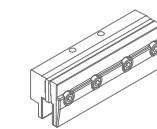

Lateral suspension	Reference
Without soft close	PN0.500
With double soft close (min. door width = 1130 mm)	PN0.500.220
With right soft close (min. door width = 730 mm)	PN0.500.020.1
With left soft close (min. door width = 730 mm)	PN0.500.020.2

Every fitting set comes with all the rollers or softclose mechanisms, suspension, guiding systems and stoppers you need.



argenta **PUNCH** CEILING MOUNT

The ceiling mount punch® can be used for doors up to 150 kg. The fully concealed glass clamps, stoppers and soft close, guarantee an almost silent operation. The running track is fit under the ceiling or can be completely concealed into a suspended ceiling. In both setups, all parts remain accessible at all times without having to cause any damage. The glass can be installed after the ceiling has been completely finished.

PROFILE LENGTH

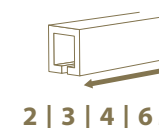

2 | 3 | 4 | 6 M

INSTALLATION



DOOR THICKNESS



8
10
12
MM

DOOR WEIGHT

MAX.
150
KG



anodised
aluminium

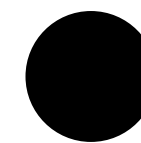

black anodised
aluminium



Stainless steel
look

Technical drawing

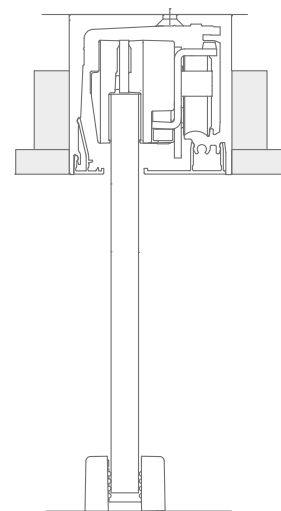
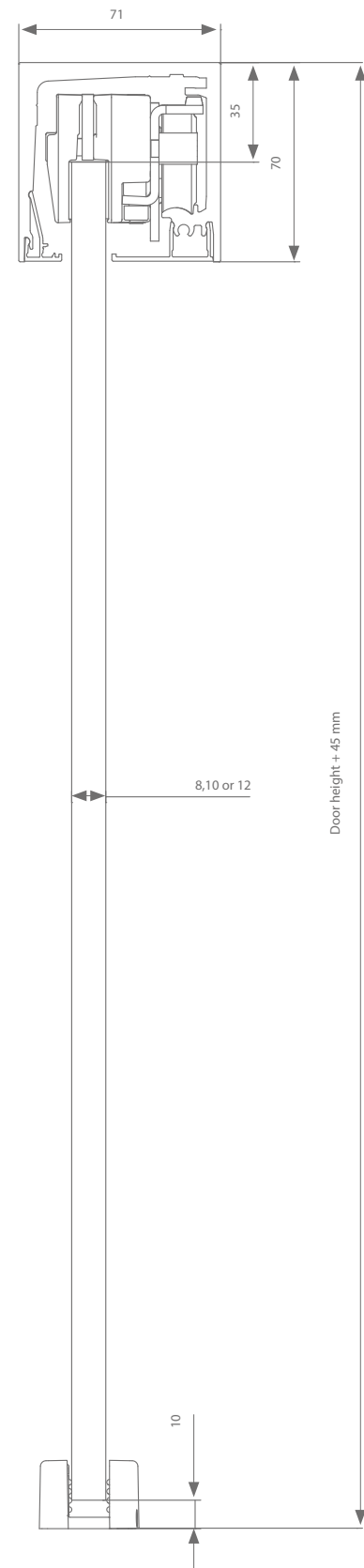

Tracks, profiles & covers

Grey anodised aluminium	Min. door width	Length	Reference
Set of tracks	1000 mm	2000 mm	PN0.200.200.0
	1500 mm	3000 mm	PN0.200.300.0
	2000 mm	4000 mm	PN0.200.400.0
	3000 mm	6000 mm	PN0.200.600.0

Set of covers	PN9.208.17		
---------------	------------	--	--

Black anodised aluminium	Min. door width	Length	Reference
Set of tracks	1000 mm	2000 mm	PN0.200.200.2
	1500 mm	3000 mm	PN0.200.300.2
	2000 mm	4000 mm	PN0.200.400.2
	3000 mm	6000 mm	PN0.200.600.2

Set of covers	PN9.208.12		
---------------	------------	--	--

Anodised aluminium with stainless steel look	Min. door width	Length	Reference
Set of tracks	1000 mm	2000 mm	PN0.200.200.7
	1500 mm	3000 mm	PN0.200.300.7
	2000 mm	4000 mm	PN0.200.400.7
	3000 mm	6000 mm	PN0.200.600.7

Set of covers	PN9.208.17		
---------------	------------	--	--

Fitting Selection

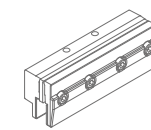

Lateral suspension	Reference
Without soft close	PN0.500
With double soft close (min. door width = 1130 mm)	PN0.500.220
With right soft close (min. door width = 730 mm)	PN0.500.020.1
With left soft close (min. door width = 730 mm)	PN0.500.020.2

Every fitting set comes with all the rollers or softclose mechanisms, suspension, guiding systems and stoppers you need.

*The glass used must always be hardened and meet safety standard EN 12150

argenta

PUNCH COMPLETE SETS CEILING MOUNT

Technical drawing

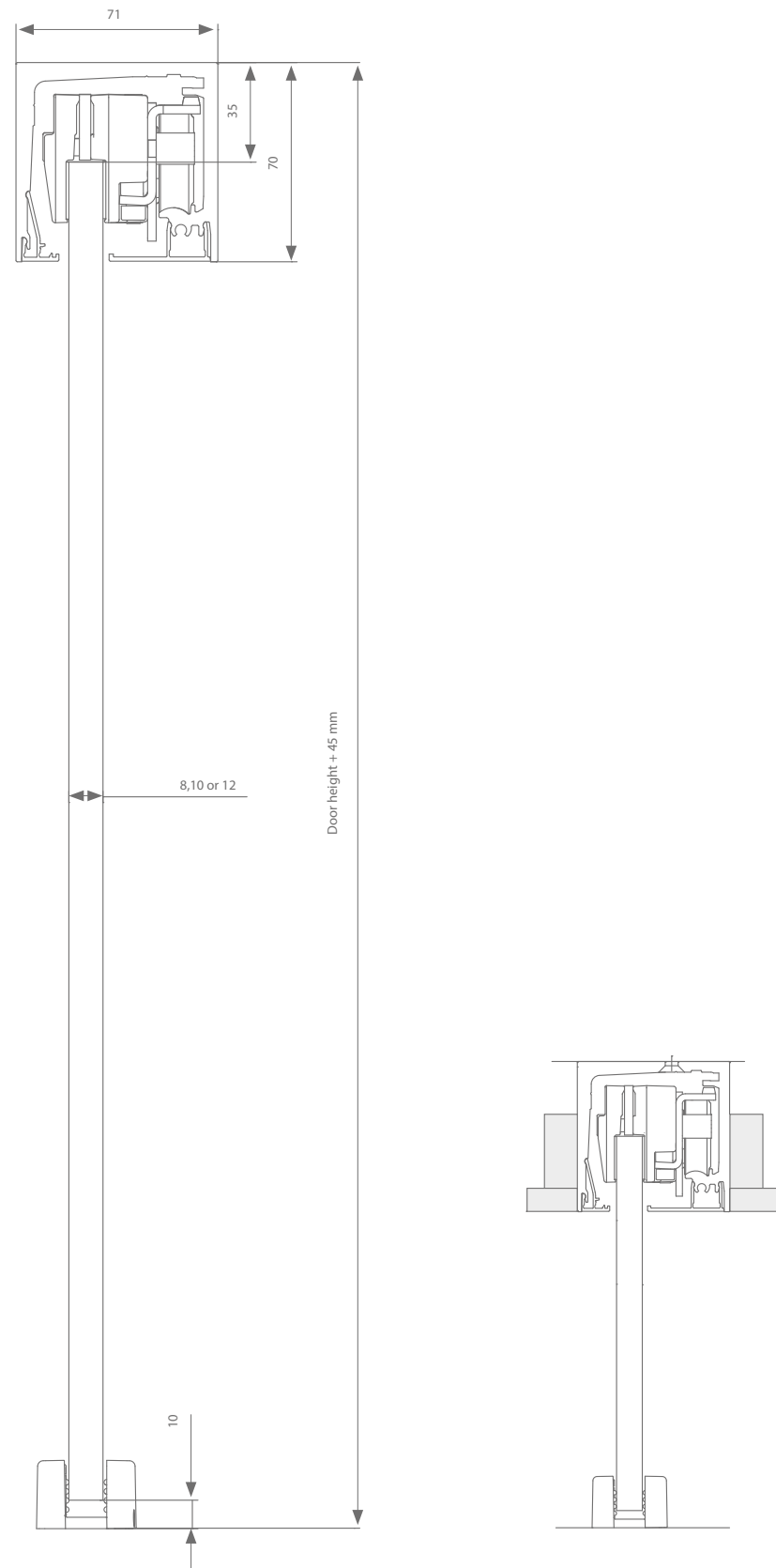

A complete set contains the following items :

- Set with all necessary profiles and covers
- 2 cover parts
- Accessories including:
 - 2 glass clamps
 - 2 rollers
 - 2 stoppers or double soft close
 - Bottom guide channel

Black anodised aluminium

Description	Min. door width	Length	Reference
Punch® without soft close	1000 mm	2000 mm	PN0.500.200.2
Punch® with double soft close*	1130 mm	2260 mm	PN0.500.220.2
Punch® without soft close	1500 mm	3000 mm	PN0.500.300.2
Punch® with double soft close*	1500 mm	3000 mm	PN0.500.320.2

Grey anodised aluminium

Description	Min. door width	Length	Reference
Punch® without soft close	1000 mm	2000 mm	PN0.500.200.0
Punch® with double soft close*	1130 mm	2260 mm	PN0.500.220.0
Punch® without soft close	1500 mm	3000 mm	PN0.500.300.0
Punch® with double soft close*	1500 mm	3000 mm	PN0.500.320.0

Anodised aluminium stainless steel look

Description	Min. door width	Length	Reference
Punch® without soft close	1000 mm	2000 mm	PN0.500.200.7
Punch® with double soft close*	1130 mm	2260 mm	PN0.500.220.7
Punch® without soft close	1500 mm	3000 mm	PN0.500.300.7
Punch® with double soft close*	1500 mm	3000 mm	PN0.500.320.7

*2 soft closes = minimum door width 1130 mm

**The glass used must always be hardened and meet safety standard EN 12150



argenta
PUNCH
 WALL MOUNT

The punch® wall mount version can be used for doors up to 150 kg. The fully concealed glass clamps, stoppers and soft close, guarantee an almost silent operation. The running track is simply attached to the wall on its own, which means that no additional wall brackets are required. The fastening points are hidden by fixing the corresponding cover strips after installation. Once again, all parts can be easily removed at a later stage without damaging the product. All profiles are available in three finishes : grey anodised aluminium, stainless steel look or black anodised aluminium.

PROFILE LENGTH

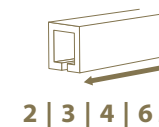

INSTALLATION



DOOR THICKNESS



DOOR WEIGHT



anodised
aluminium

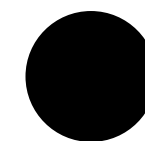

black anodised
aluminium



stainless steel
look

Technical drawing

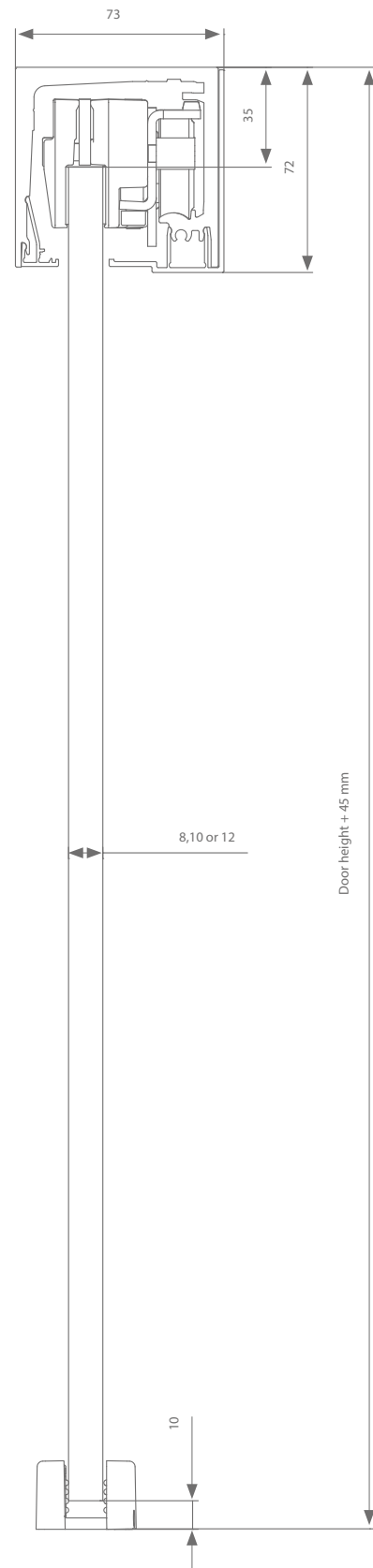

Tracks, profiles & covers

Grey anodised aluminium	Min. door width	Length	Length
Set of tracks	1000 mm	2000 mm	PN0.210.200.0
	1500 mm	3000 mm	PN0.210.300.0
	2000 mm	4000 mm	PN0.210.400.0
	3000 mm	6000 mm	PN0.210.600.0

Set of covers	PN9.218.17		
---------------	------------	--	--

Black anodised aluminium	Min. door width	Length	Length
Set of tracks	1000 mm	2000 mm	PN0.210.200.2
	1500 mm	3000 mm	PN0.210.300.2
	2000 mm	4000 mm	PN0.210.400.2
	3000 mm	6000 mm	PN0.210.600.2

Set of covers	PN9.218.12		
---------------	------------	--	--

Anodised aluminium with stainless steel look	Min. door width	Length	Length
Set of tracks	1000 mm	2000 mm	PN0.210.200.7
	1500 mm	3000 mm	PN0.210.300.7
	2000 mm	4000 mm	PN0.210.400.7
	3000 mm	6000 mm	PN0.210.600.7

Set of covers	PN9.218.17		
---------------	------------	--	--

Fitting Selection

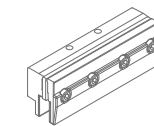

Lateral suspension	Reference
Without soft close	PN0.500
With double soft close (min. door width = 1130 mm)	PN0.500.220
With right soft close (min. door width = 730 mm)	PN0.500.020.1
With left soft close (min. door width = 730 mm)	PN0.500.020.2

Every fitting set comes with all the rollers or softclose mechanisms, suspension, guiding systems and stoppers you need.

*The glass used must always be hardened and meet safety standard EN 12150

argenta
PUNCH TOTAL SETS WALL MOUNT

Technical drawing

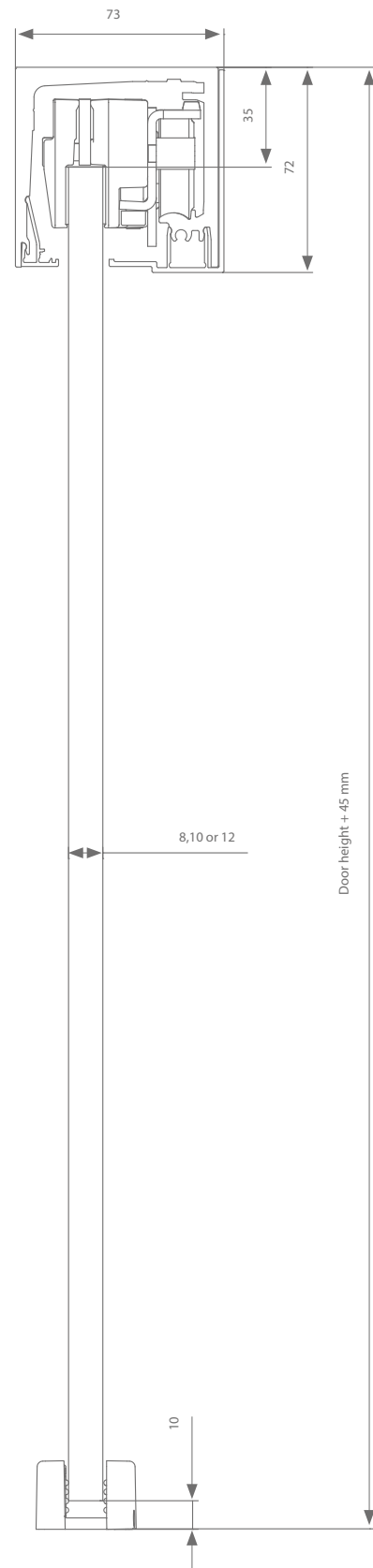

A complete set contains the following items :

- Set with all necessary tracks and covers
- 2 cover parts
- Accessories including:
 - 2 glass clamps
 - 2 rollers
 - 2 stoppers or double soft close
 - Bottom guide channel

Black anodised aluminium

Description	Min. door width	Length	Reference
Punch® without soft close	1000 mm	2000 mm	PN0.510.200.2
Punch® with double soft close*	1130 mm	2260 mm	PN0.510.220.2
Punch® without soft close	1500 mm	3000 mm	PN0.510.300.2
Punch® with double soft close*	1500 mm	3000 mm	PN0.510.320.2

Grey anodised aluminium

Description	Min. door width	Length	Reference
Punch® without soft close	1000 mm	2000 mm	PN0.510.200.0
Punch® with double soft close*	1130 mm	2260 mm	PN0.510.220.0
Punch® without soft close	1500 mm	3000 mm	PN0.510.300.0
Punch® with double soft close*	1500 mm	3000 mm	PN0.510.320.0

Anodised aluminium stainless steel look

Description	Min. door width	Length	Reference
Punch® without soft close	1000 mm	2000 mm	PN0.510.200.7
Punch® with double soft close*	1130 mm	2260 mm	PN0.510.220.7
Punch® without soft close	1500 mm	3000 mm	PN0.510.300.7
Punch® with double soft close*	1500 mm	3000 mm	PN0.510.320.7

*2 soft closes = minimum door width 1130 mm

**The glass used must always be hardened and meet safety standard EN 12150



02

EXPERT GLASS

Sometime, ARLU® successfully launched the expert range for interior applications. Numerous references show that this high quality fitting has become an established value within the ARLU range. Expert offers a qualitative added value and guarantees a long lifespan.

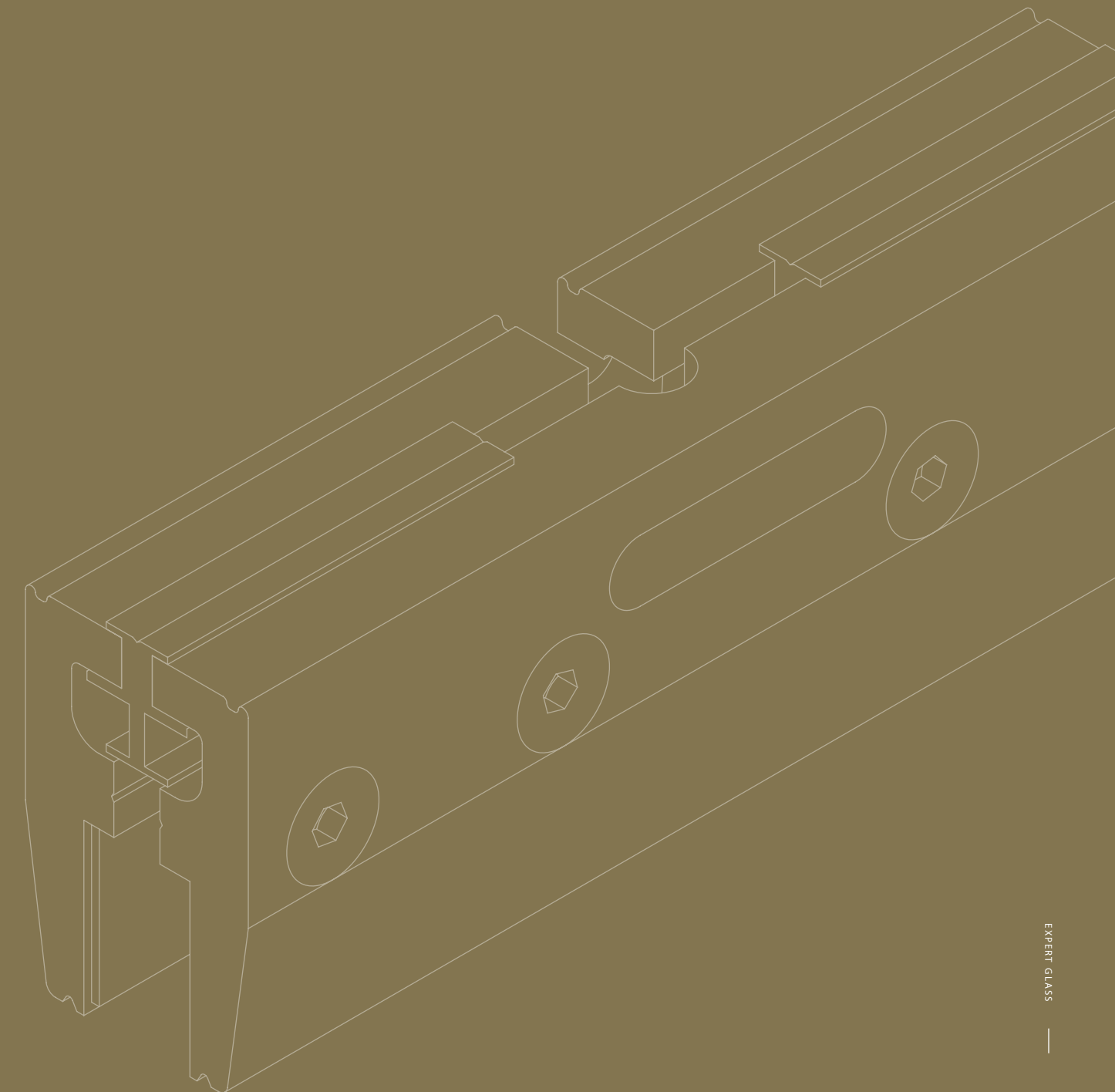



argenta expert glass
general information

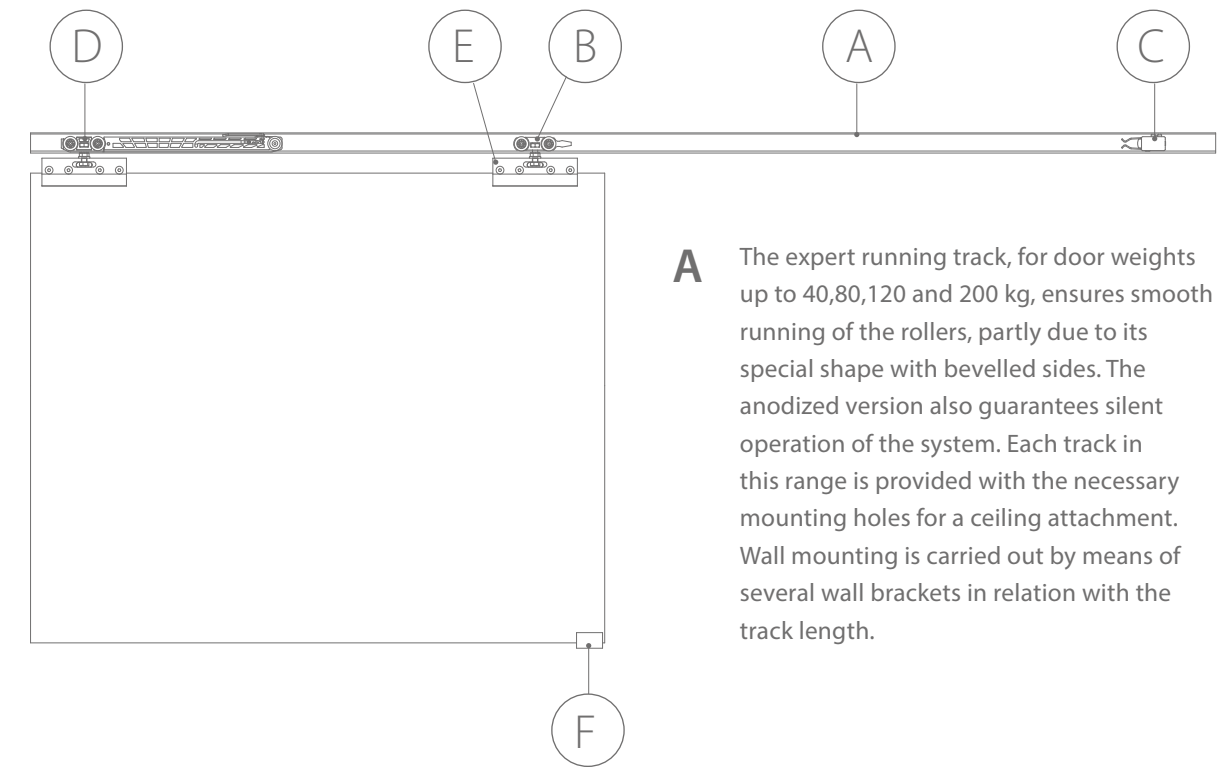

A The expert running track, for door weights up to 40,80,120 and 200 kg, ensures smooth running of the rollers, partly due to its special shape with bevelled sides. The anodized version also guarantees silent operation of the system. Each track in this range is provided with the necessary mounting holes for a ceiling attachment. Wall mounting is carried out by means of several wall brackets in relation with the track length.

B The ball bearings ensure a light and quiet operation of the sliding door. A superior plastic roller with additional ball bearings for a superior quality has also been developed in the 80, 120 and 200 kg range.

C When the door comes to its end position, the roller is caught by the stopper which will then hold it in open or closed position. The stopper is easy to move and the clamping force is adjustable. The stopper in the 80 kg superior series is equipped with a stainless steel clamp which also guarantees a long lifespan.

D Expert offers the option of choosing a soft close and / or a soft open to allow the door to close or open softly. This option is also recommended as a finger protection for children. Just like the rollers, the wheels of the soft close are fitted with ball bearings. Can be used for doors of 40,80 or 120 kg.

E The glass clamp for glass thicknesses of 8.10 or 12 mm is able to support the glass panel without the glass having to be pierced.

F A bottom guide, adjustable for the 3 glass thicknesses, always guarantees the vertical position of the door during opening or closing.



argenta
EXPERT
 40 KG

This sliding door fitting allows glass doors up to 40 kg to be moved in a quiet and gentle way. Glass thicknesses of 8,10 or 12 mm can be used. Stoppers and soft close ensure flawless quiet operation. A bottom guide that is adjustable for the 3 glass thicknesses ensures that the door is always perpendicular during opening or closing. Thanks to a series of cover profiles and corresponding end caps, the system is beautifully and sleekly finished.

PROFILE LENGTH

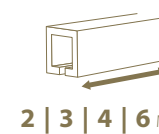

2 | 3 | 4 | 6 M

INSTALLATION



DOOR THICKNESS



8
 10
 12
 MM

DOOR WEIGHT



MAX.
 40
 KG



anodised
 aluminium

Technical drawing

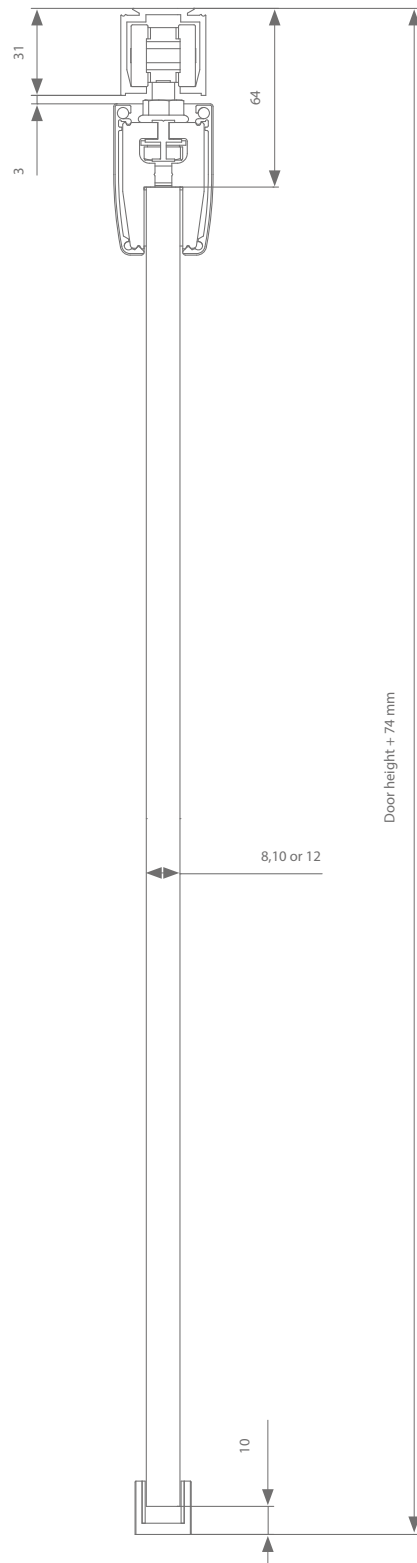

Height adjustment: +/- 3 mm

Tracks, profiles & covers

	Max. door width	Length	Reference
Running track	1000 mm	2000 mm	AG0.208.200
	1500 mm	3000 mm	AG0.208.300
	2000 mm	4000 mm	AG0.208.400
	3000 mm	6000 mm	AG0.208.600
Glass clamps cover profile	1000 mm	2000 mm	AK7.918.200
	1500 mm	3000 mm	AK7.918.300
	2000 mm	4000 mm	AK7.918.400
	3000 mm	6000 mm	AK7.918.600
+ end caps (2x):			
8mm door thickness			AK9.978.008
10mm door thickness			AK9.978.010
12mm door thickness			AK9.978.012

Fitting Selection

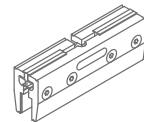

Transverse suspension	Reference
Without soft close	AG0.500
With 1 soft close (min. door width = 502 mm)	AG0.500.020
With double soft close (min. door width = 739 mm)	AG0.500.220

Every fitting set comes with all the rollers or softclose mechanisms, suspension, guiding systems and stoppers you need.

*The glass used must always be hardened and meet safety standard EN 12150

Technical drawing

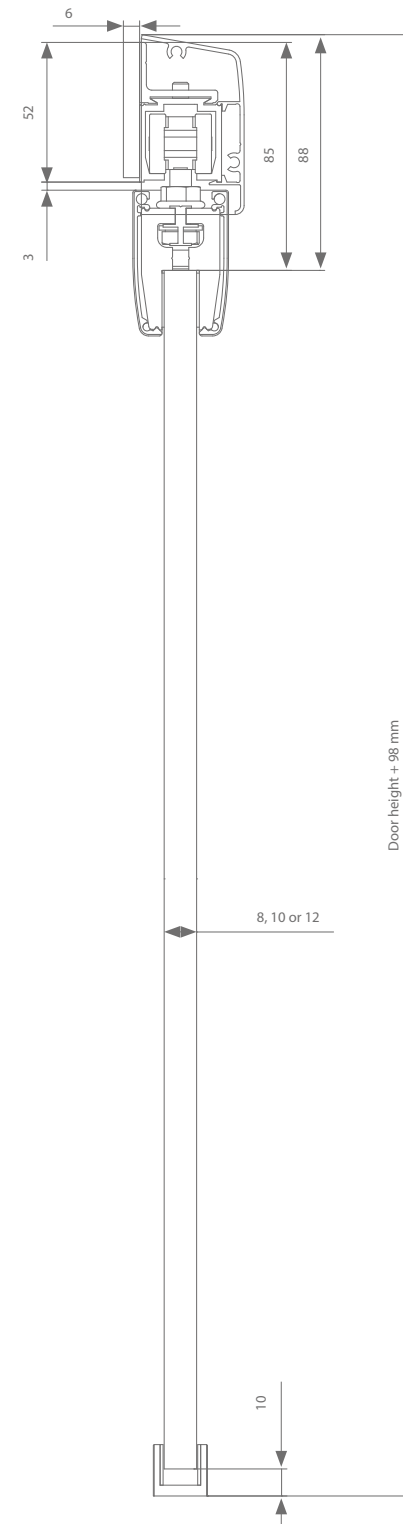

Height adjustment: +/- 3 mm

Tracks, profiles & covers

	Max. door width	Length	Reference
Running track	1000 mm	2000 mm	AG0.208.200
	1500 mm	3000 mm	AG0.208.300
	2000 mm	4000 mm	AG0.208.400
	3000 mm	6000 mm	AG0.208.600
Wall bracket	Required every 500 - 600 mm		AK1.118.0
Cover profile	1000 mm	2000 mm	AK0.928.200
	1500 mm	3000 mm	AK0.928.300
	2000 mm	4000 mm	AK0.928.400
	3000 mm	6000 mm	AK0.928.600
+ end caps			
			AK9.958
Glass clamps cover profile	1000 mm	2000 mm	AK7.918.200
	1500 mm	3000 mm	AK7.918.300
	2000 mm	4000 mm	AK7.918.400
	3000 mm	6000 mm	AK.918.600
+ end caps (2x):			
8mm door thickness			AK9.978.008
10mm door thickness			AK9.978.010
12 mm door thickness			AK9.978.012

Fitting Selection

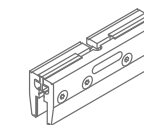

Transverse suspension	Reference
Without soft close	AG0.500
With 1 soft close (min. door width = 502 mm)	AG0.500.020
With double soft close (min. door width = 739 mm)	AG0.500.220

Every fitting set comes with all the rollers or softclose mechanisms, suspension, guiding systems and stoppers you need.

*The glass used must always be hardened and meet safety standard EN 12150



argenta
EXPERT
80 KG

This sliding door fitting allows glass doors up to 80 kg to be moved in a quiet and gentle way. Door thicknesses of 8.10 or 12 mm are possible. Stoppers and soft close ensure flawless quiet operation. A bottom guide that is adjustable for the 3 glass thicknesses ensures that the door is always perpendicular during opening or closing. Thanks to a series of cover profiles and corresponding end caps, the system is beautifully and sleekly finished.

PROFILE LENGTH

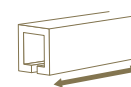

2 | 3 | 4 | 6 M

INSTALLATION



DOOR THICKNESS



DOOR WEIGHT



anodised
aluminium

Technical drawing

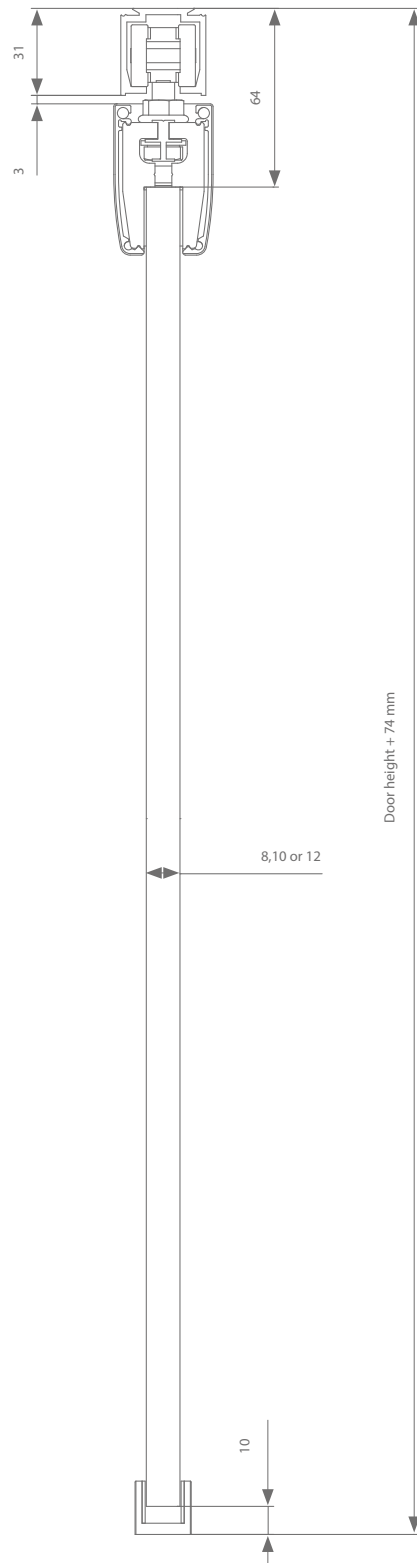

Height adjustment: +/- 3 mm

Tracks, profiles & covers

	Max. door width	Length	Reference
Running track	1000 mm	2000 mm	AK0.208.200
	1500 mm	3000 mm	AK0.208.300
	2000 mm	4000 mm	AK0.208.400
	3000 mm	6000 mm	AK0.208.600
Glass clamps cover profile	1000 mm	2000 mm	AK7.918.200
	1500 mm	3000 mm	AK7.918.300
	2000 mm	4000 mm	AK7.918.400
	3000 mm	6000 mm	AK7.918.600
+ end caps (2x):			
8mm door thickness			AK9.978.008
10mm door thickness			AK9.978.010
12mm door thickness			AK9.978.012

Fitting Selection

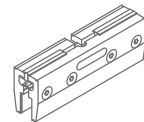

Transverse suspension	Reference
Without soft close	AK0.500
With 1 soft close (min. door width = 502 mm)	AK0.500.020

Every fitting set comes with all the rollers or softclose mechanisms, suspension, guiding systems and stoppers you need.

*The glass used must always be hardened and meet safety standard EN 12150

Technical drawing

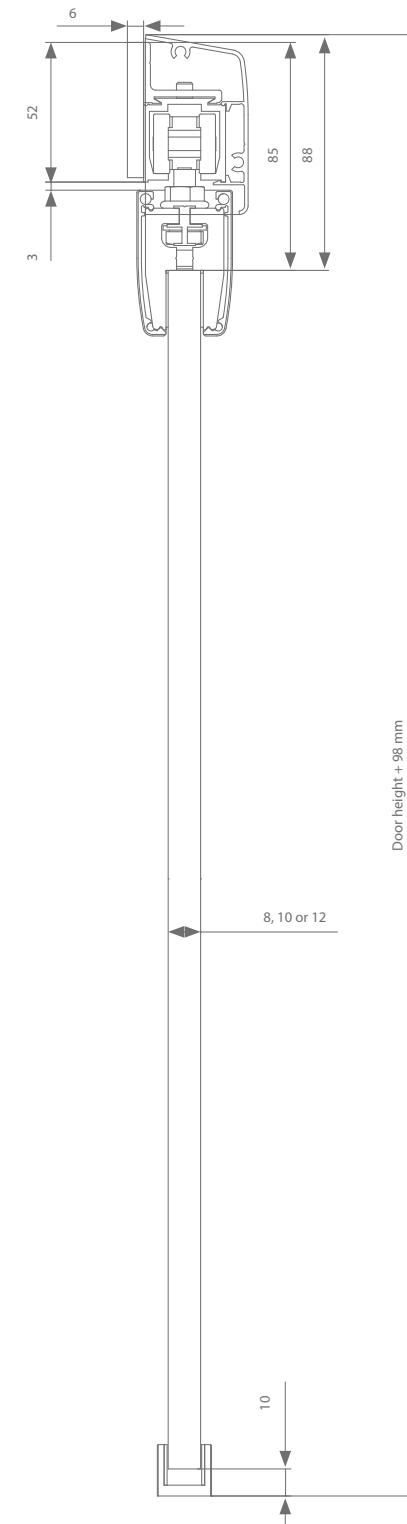

Height adjustment: +/- 3 mm

Tracks, profiles & covers

	Max. door width	Length	Reference
Running track	1000 mm	2000 mm	AK0.208.200
	1500 mm	3000 mm	AK0.208.300
	2000 mm	4000 mm	AK0.208.400
	3000 mm	6000 mm	AK0.208.600
Wall bracket	Required every 500 - 600 mm		AK1.118.0
Cover profile	1000 mm	2000 mm	AK0.928.200
	1500 mm	3000 mm	AK0.928.300
	2000 mm	4000 mm	AK0.928.400
	3000 mm	6000 mm	AK0.928.600
+ end caps			
			AK9.958
Glass clamps cover profile	1000 mm	2000 mm	AK7.918.200
	1500 mm	3000 mm	AK7.918.300
	2000 mm	4000 mm	AK7.918.400
	3000 mm	6000 mm	AK.918.600
+ end caps (2x):			
8mm door thickness			AK9.978.008
10mm door thickness			AK9.978.010
12 mm door thickness			AK9.978.012

Fitting Selection

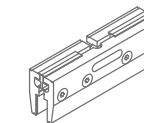

Transverse suspension	Reference
Without soft close	AK0.500
With 1 soft close (min. door width = 502 mm)	AK0.500.020

Every fitting set comes with all the rollers or softclose mechanisms, suspension, guiding systems and stoppers you need.

*The glass used must always be hardened and meet safety standard EN 12150



argenta
EXPERT
 80 KG SUPERIOR

From the 80 kg series, expert offers a superior range. These products guarantee a longer lifespan and quieter operation. Expert 80 kg superior enables extra silent and smooth movement of glass doors of up to 80 kg. This is because the rollers in these fittings are equipped with additional ball bearings of superior quality for extremely discreet operation. Door thicknesses of 8, 10 or 12 mm can be used stoppers and soft close(s) ensure flawless quiet operation. The 80 kg superior stopper is fitted with an extra-strong stainless steel spring clamp that guarantees a longer lifespan. A bottom guiding channel that can be adjusted to fit all three glass thicknesses guarantees the door always remains at a perfect right angle during opening and closing. The system is neatly finished with cover profiles and endcaps.

PROFILE LENGTH

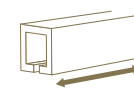

2 | 3 | 4 | 6 M

INSTALLATION



DOOR THICKNESS



8
10
12
MM

DOOR WEIGHT



anodised
aluminium

Technical drawing

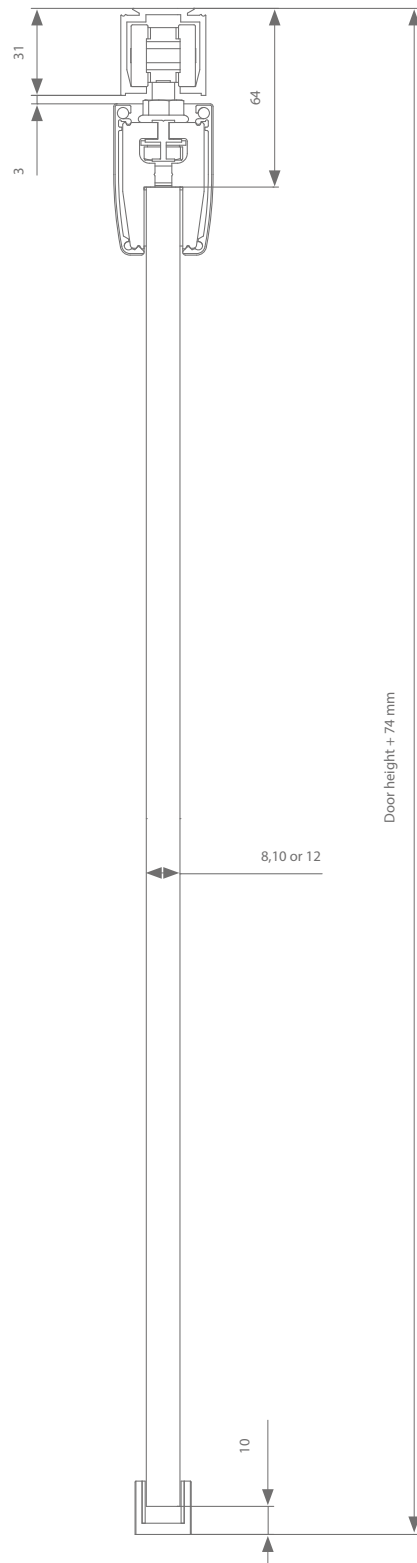

Height adjustment: +/- 3 mm

Tracks, profiles & covers

	Max. door width	Length	Reference
Running track	1000 mm	2000 mm	AK0.208.200
	1500 mm	3000 mm	AK0.208.300
	2000 mm	4000 mm	AK0.208.400
	3000 mm	6000 mm	AK0.208.600
Glass clamps cover profile	1000 mm	2000 mm	AK7.918.200
	1500 mm	3000 mm	AK7.918.300
	2000 mm	4000 mm	AK7.918.400
	3000 mm	6000 mm	AK7.918.600
+ end caps (2x):			
8mm door thickness			AK9.978.008
10mm door thickness			AK9.978.010
12mm door thickness			AK9.978.012

Fitting Selection

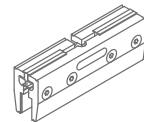

Transverse suspension	Reference
Without soft close	AK0.500.080
With 1 soft close (min. door width = 502 mm)	AK0.500.080.20
With double soft close (min. door width = 739 mm)	AK0.500.082.20

Every fitting set comes with all the rollers or softclose mechanisms, suspension, guiding systems and stoppers you need.

*The glass used must always be hardened and meet safety standard EN 12150

Technical drawing

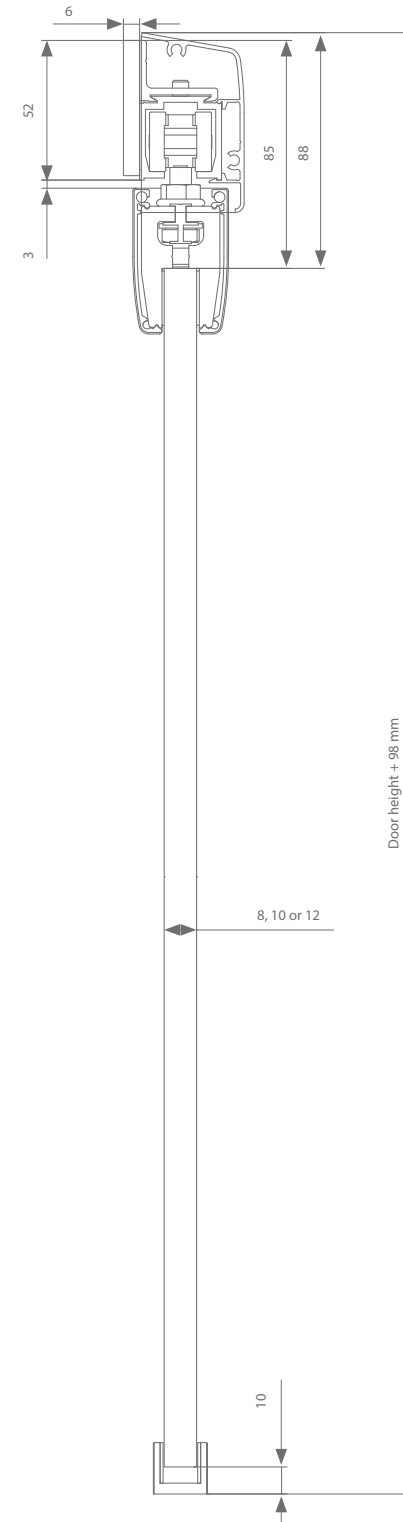

Height adjustment: +/- 3 mm

Tracks, profiles & covers

	Max. door width	Length	Reference
Running track	1000 mm	2000 mm	AK0.208.200
	1500 mm	3000 mm	AK0.208.300
	2000 mm	4000 mm	AK0.208.400
	3000 mm	6000 mm	AK0.208.600
Wall bracket	Required every 500 - 600 mm		AK1.118.0
Cover profile	1000 mm	2000 mm	AK0.928.200
	1500 mm	3000 mm	AK0.928.300
	2000 mm	4000 mm	AK0.928.400
	3000 mm	6000 mm	AK0.928.600
+ end caps			
			AK9.958
Glass clamps cover profile	1000 mm	2000 mm	AK7.918.200
	1500 mm	3000 mm	AK7.918.300
	2000 mm	4000 mm	AK7.918.400
	3000 mm	6000 mm	AK7.918.600
+ end caps (2x):			
8mm door thickness			AK9.978.008
10mm door thickness			AK9.978.010
12 mm door thickness			AK9.978.012

Fitting Selection

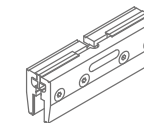

Transverse suspension	Reference
Without soft close	AK0.500.080
With 1 soft close (min. door width = 502 mm)	AK0.500.080.20
With double soft close (min. door width = 739 mm)	AK0.500.082.20

Every fitting set comes with all the rollers or softclose mechanisms, suspension, guiding systems and stoppers you need.

*The glass used must always be hardened and meet safety standard EN 12150



argenta
EXPERT
 120 KG SUPERIOR

This sliding door hardware enables silent and smooth movement of glass doors of up to 120 kg. Door thicknesses of 8, 10 or 12 mm can be used; stoppers and soft close(s) ensure extremely silent operation. A bottom guide that can be adjusted to fit all three glass thicknesses guarantees the door always remains at a perfect right angle during opening and closing. The system is neatly finished with cover profiles and endcaps

PROFILE LENGTH

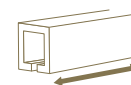

2 | 3 | 4 | 6 M

INSTALLATION



DOOR THICKNESS



8
10
12
MM

DOOR WEIGHT



MAX.
120
KG



anodised
aluminium

Technical drawing

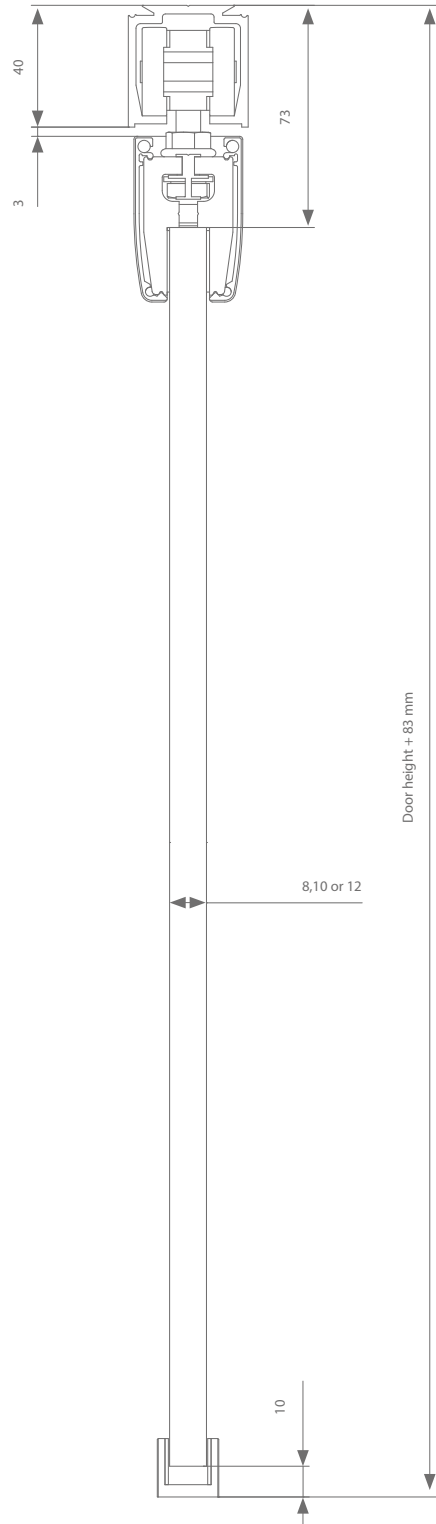

Door height + 83 mm

8,10 or 12

10

Height adjustment: +/- 5 mm

Tracks, profiles & covers

	Max. door width	Length	Reference
Running track	1000 mm	2000 mm	AM0.208.200
	1500 mm	3000 mm	AM0.208.300
	2000 mm	4000 mm	AM0.208.400
	3000 mm	6000 mm	AM0.208.600
Glass clamps cover profile	1000 mm	2000 mm	AK7.918.200
	1500 mm	3000 mm	AK7.918.300
	2000 mm	4000 mm	AK7.918.400
	3000 mm	6000 mm	AK7.918.600
End caps (2x):			
8mm door thickness			AK9.978.008
10mm door thickness			AK9.978.010
12mm door thickness			AK9.978.012

Fitting Selection

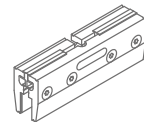

Transverse suspension	Reference
Without soft close	AM0.500
With 1 soft close (min. door width = 553 mm)	AM0.500.020
With double soft close (min. door width = 789 mm)	AM0.500.220

Every fitting set comes with all the rollers or softclose mechanisms, suspension, guiding systems and stoppers you need.

*The glass used must always be hardened and meet safety standard EN 12150

Technical drawing

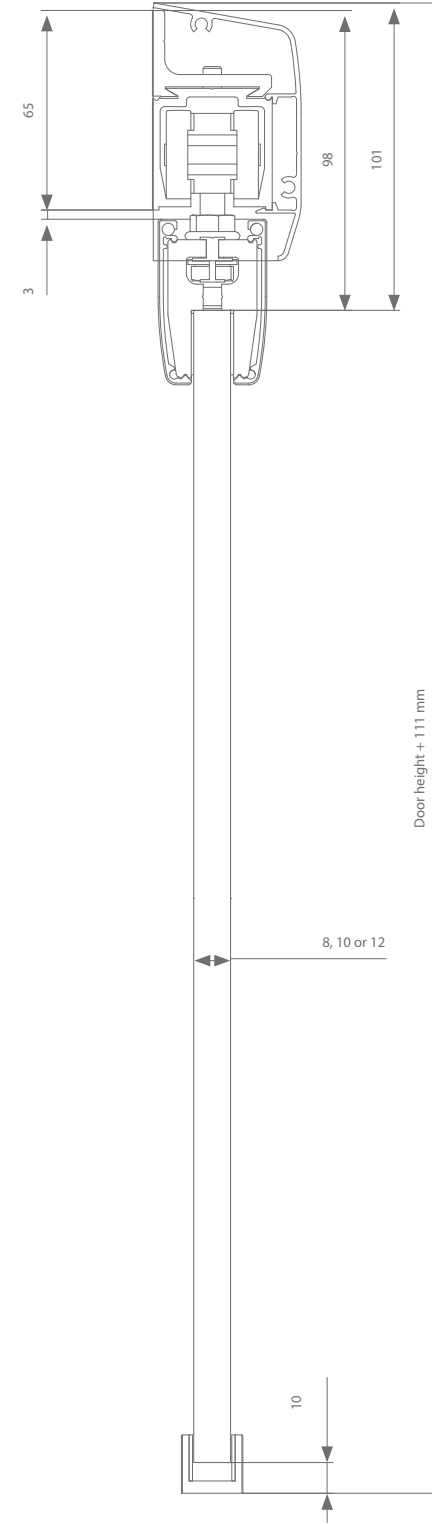

Door height + 111 mm

8, 10 or 12

10

Height adjustment: +/- 5 mm

Tracks, profiles & covers

	Max. door width	Length	Reference
Running track	1000 mm	2000 mm	AM0.208.200
	1500 mm	3000 mm	AM0.208.300
	2000 mm	4000 mm	AM0.208.400
	3000 mm	6000 mm	AM0.208.600
Wall bracket	Required every 500 - 600 mm		AM1.118.0
Cover profile	1000 mm	2000 mm	AM0.928.200
	1500 mm	3000 mm	AM0.928.300
	2000 mm	4000 mm	AM0.928.400
	3000 mm	6000 mm	AM0.928.600
+ end caps			AM9.958
Glass clamps cover profile	1000 mm	2000 mm	AK7.918.200
	1500 mm	3000 mm	AK7.918.300
	2000 mm	4000 mm	AK7.918.400
	3000 mm	6000 mm	AK7.918.600
End caps (2x):			
8mm door thickness			AK9.978.008
10mm door thickness			AK9.978.010
12 mm door thickness			AK9.978.012

Fitting Selection

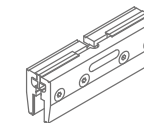

Transverse suspension	Reference
Without soft close	AM0.500
With 1 soft close (min. door width = 553 mm)	AM0.500.020
With double soft close (min. door width = 789 mm)	AK0.500.220

Every fitting set comes with all the rollers or softclose mechanisms, suspension, guiding systems and stoppers you need.

*The glass used must always be hardened and meet safety standard EN 12150



03

CUBE GLASS

The cube hardware has a much sleeker appearance as no wall brackets are required. The running profile comes with drilled holes on the side, so it can be fixed onto the wall in no time at all.

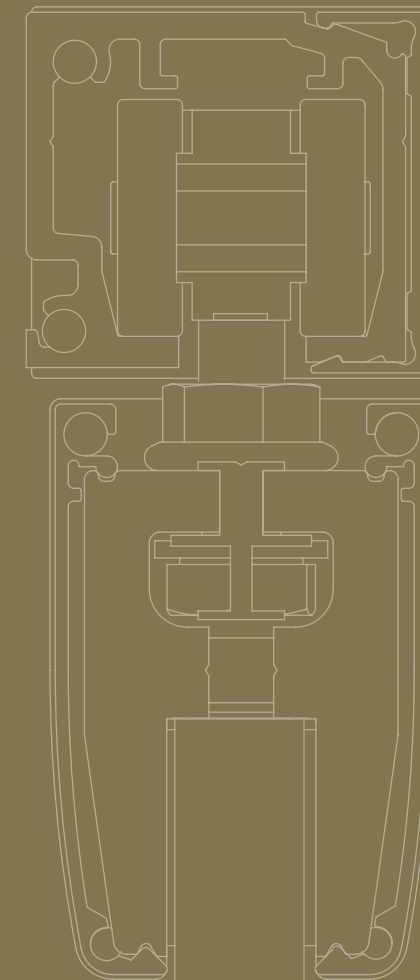



argenta
CUBE
 40 - 80 KG

The system is discreetly finished with a cover profile and the associated end caps. Cube is available in grey anodised aluminium.

PROFILE LENGTH

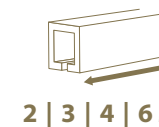

2 | 3 | 4 | 6 M

INSTALLATION



DOOR THICKNESS



8
10
12
MM

DOOR WEIGHT



MAX.
80
KG



grey anodised
aluminium

Technical drawing

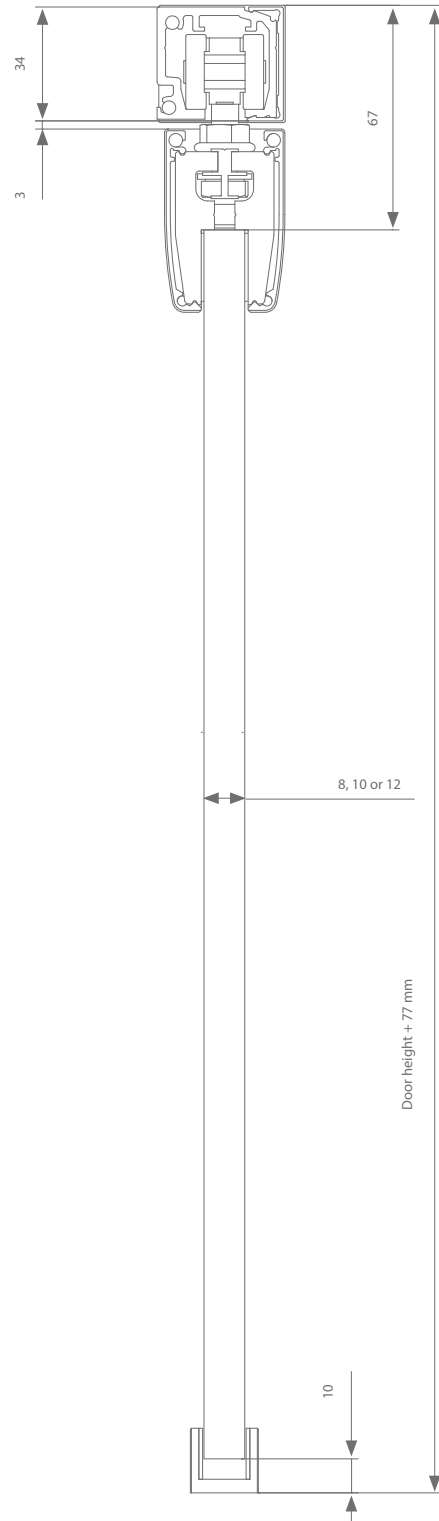

Tracks, profiles & covers

	Max. door width	Length	Reference
Running track	1000 mm	2000 mm	AG1.158.200
	1500 mm	3000 mm	AG1.158.300
	2000 mm	4000 mm	AG1.158.400
	3000 mm	6000 mm	AG1.158.600
Cover profile	1000 mm	2000 mm	AK1.918.200
	1500 mm	3000 mm	AK1.918.300
	2000 mm	4000 mm	AK1.918.400
	3000 mm	6000 mm	AK1.918.600
+ end caps			AK9.158
Glass clamps cover profile	1000 mm	2000 mm	AK7.918.200
	1500 mm	3000 mm	AK7.918.300
	2000 mm	4000 mm	AK7.918.400
	3000 mm	6000 mm	AK7.918.600
End caps (2x):			
8mm door thickness			AK9.978.008
10mm door thickness			AK9.978.010
12 mm door thickness			AK9.978.012

Fitting Selection

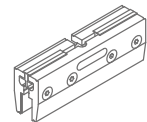

Transverse suspension	Reference
Without soft close	AG0.500
With 1 soft close (min. door width = 502 mm)	AG0.500.020
With double soft close (min. door width = 739 mm)	AG0.500.220

Every fitting set comes with all the rollers or softclose mechanisms, suspension, guiding systems and stoppers you need.

Height adjustment: +/- 3 mm

*The glass used must always be hardened and meet safety standard EN 12150

Technical drawing

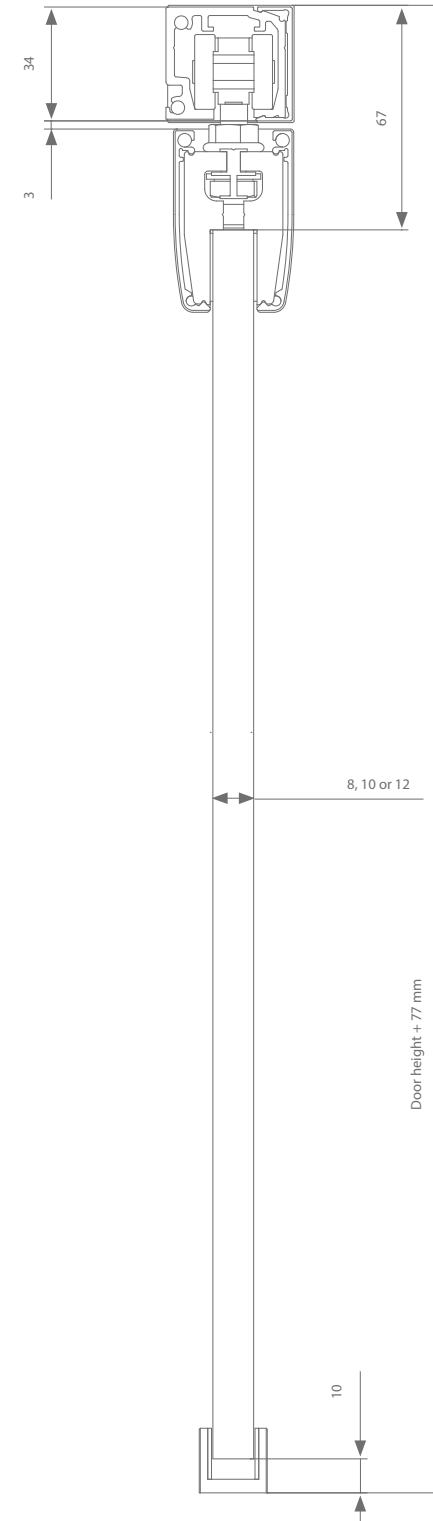

Tracks, profiles & covers

	Max. door width	Length	Reference
Running track	1000 mm	2000 mm	AK1.158.200
	1500 mm	3000 mm	AK1.158.300
	2000 mm	4000 mm	AK1.158.400
	3000 mm	6000 mm	AK1.158.600
Cover profile	1000 mm	2000 mm	AK1.918.200
	1500 mm	3000 mm	AK1.918.300
	2000 mm	4000 mm	AK1.918.400
	3000 mm	6000 mm	AK1.918.600
+ end caps			AK9.158
Glass clamps cover profile	1000 mm	2000 mm	AK7.918.200
	1500 mm	3000 mm	AK7.918.300
	2000 mm	4000 mm	AK7.918.400
	3000 mm	6000 mm	AK7.918.600
End caps (2x):			
8mm door thickness			AK9.978.008
10mm door thickness			AK9.978.010
12 mm door thickness			AK9.978.012

Fitting Selection

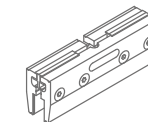

Transverse suspension	Reference
Without soft close	AK0.500.080
With 1 soft close (min. door width = 502 mm)	AK0.500.080.20
With double soft close (min. door width = 739 mm)	AK0.500.082.20

Every fitting set comes with all the rollers or softclose mechanisms, suspension, guiding systems and stoppers you need.

Height adjustment: +/- 3 mm

*The glass used must always be hardened and meet safety standard EN 12150



04

CUBE CRYSTAL

As mentioned before, the cube running track comes with drilled holes on the side, meaning it can be fixed onto the wall in no time at all. Cube crystal goes one step further and makes it possible to fit a Cube profile into a glass wall. By mirroring the cover profile at the rear side of the glass wall, the system obtains an extremely sleek and minimal finish.

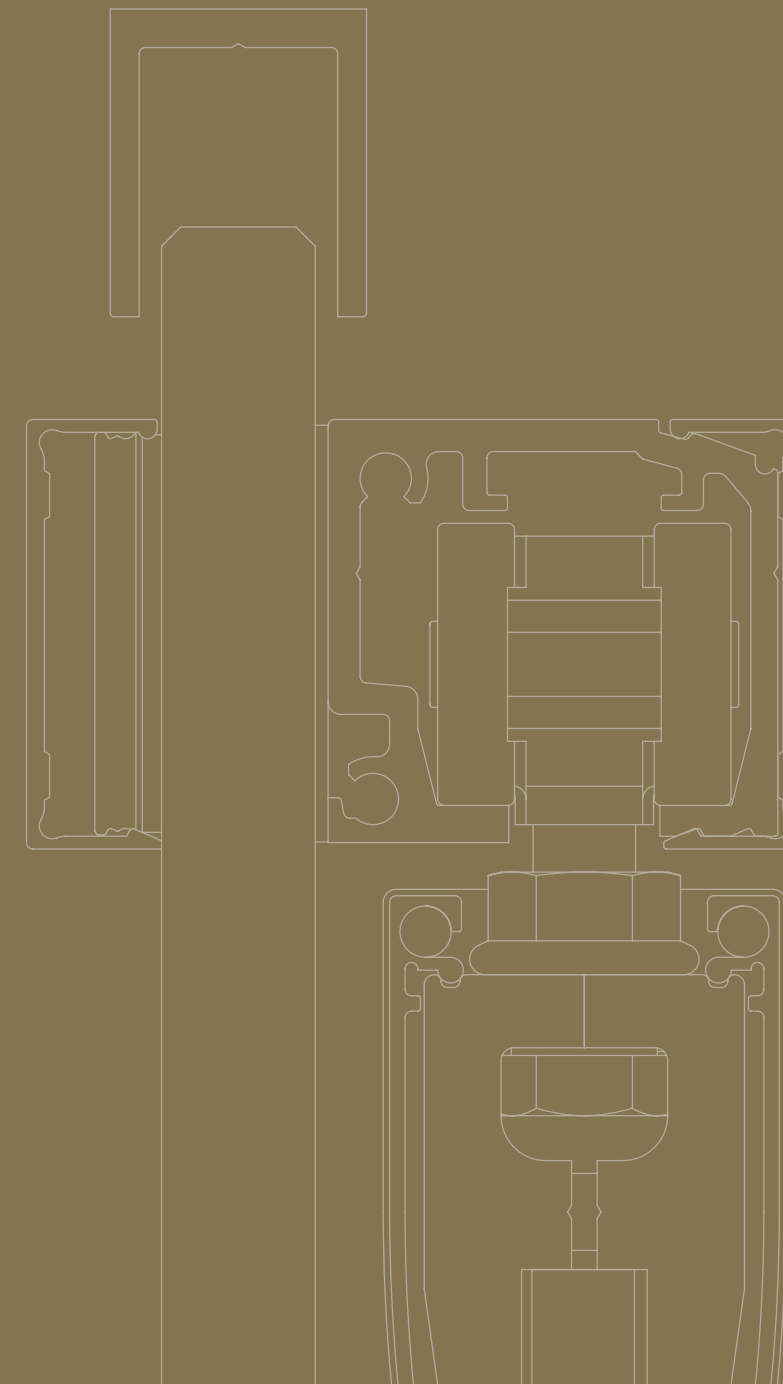



argenta
CUBE CRYSTAL
 80 KG

Cube crystal creates a minimalist glass sliding door mounted on a glass wall and sleekly finished on both sides. The running track is clamped to the wall and is able to move a glass sliding door weighing up to 80 kg.

PROFILE LENGTH

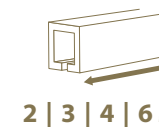

INSTALLATION



DOOR THICKNESS

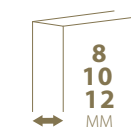

DOOR WEIGHT



anodised
 aluminium

Technical drawing

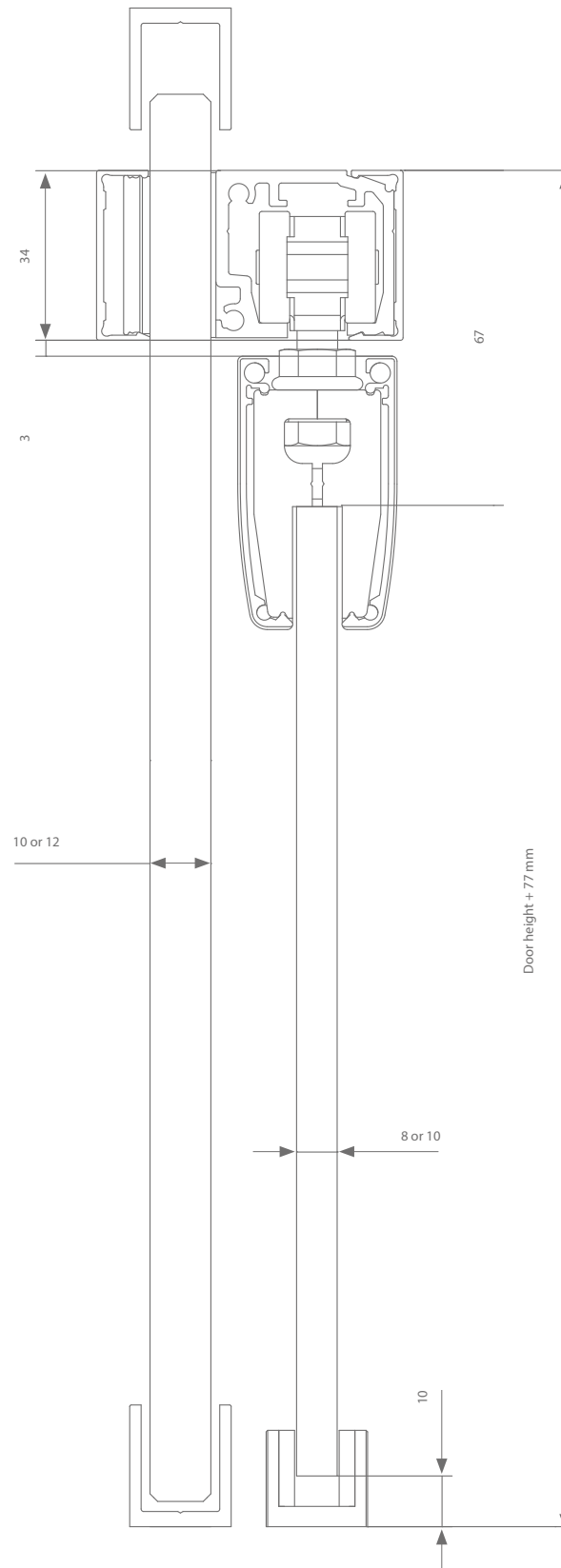

Height adjustment: + / - 3 mm

Tracks, profiles & covers

	Max. door width	Length	Reference
Running track	1000 mm	2000 mm	AK1.158.200
	1500 mm	3000 mm	AK1.158.300
	2000 mm	4000 mm	AK1.158.400
	3000 mm	6000 mm	AK1.158.600
Cover profile	1000 mm	2000 mm	AK1.918.200
	1500 mm	3000 mm	AK1.918.300
	2000 mm	4000 mm	AK1.918.400
	3000 mm	6000 mm	AK1.918.600
Glass clamps cover profile	1000 mm	2000 mm	AK7.918.200
	1500 mm	3000 mm	AK7.918.300
	2000 mm	4000 mm	AK7.918.400
	3000 mm	6000 mm	AK7.918.600
+ end caps (2x):			
8mm door thickness			AK9.978.008
10mm door thickness			AK9.978.010
12 mm door thickness			AK9.978.012
Accessories set			AK1.150.9

Fitting Selection

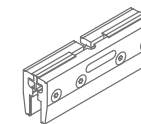

Transverse suspension	Reference
Without soft close	AK0.500.080
With 1 soft close (min. door width = 502 mm)	AK0.500.080.20
With double soft close (min. door width = 739 mm)	AK0.500.082.20

Every fitting set comes with all the rollers or softclose mechanisms, suspension, guiding systems and stoppers you need.

*The glass used must always be hardened and meet safety standard EN 12150



05

LATENT GLASS

The latent sliding door system is almost completely invisible thanks to its extremely fine running track that is fully concealed in the ceiling behind a 12.5 mm plasterboard.

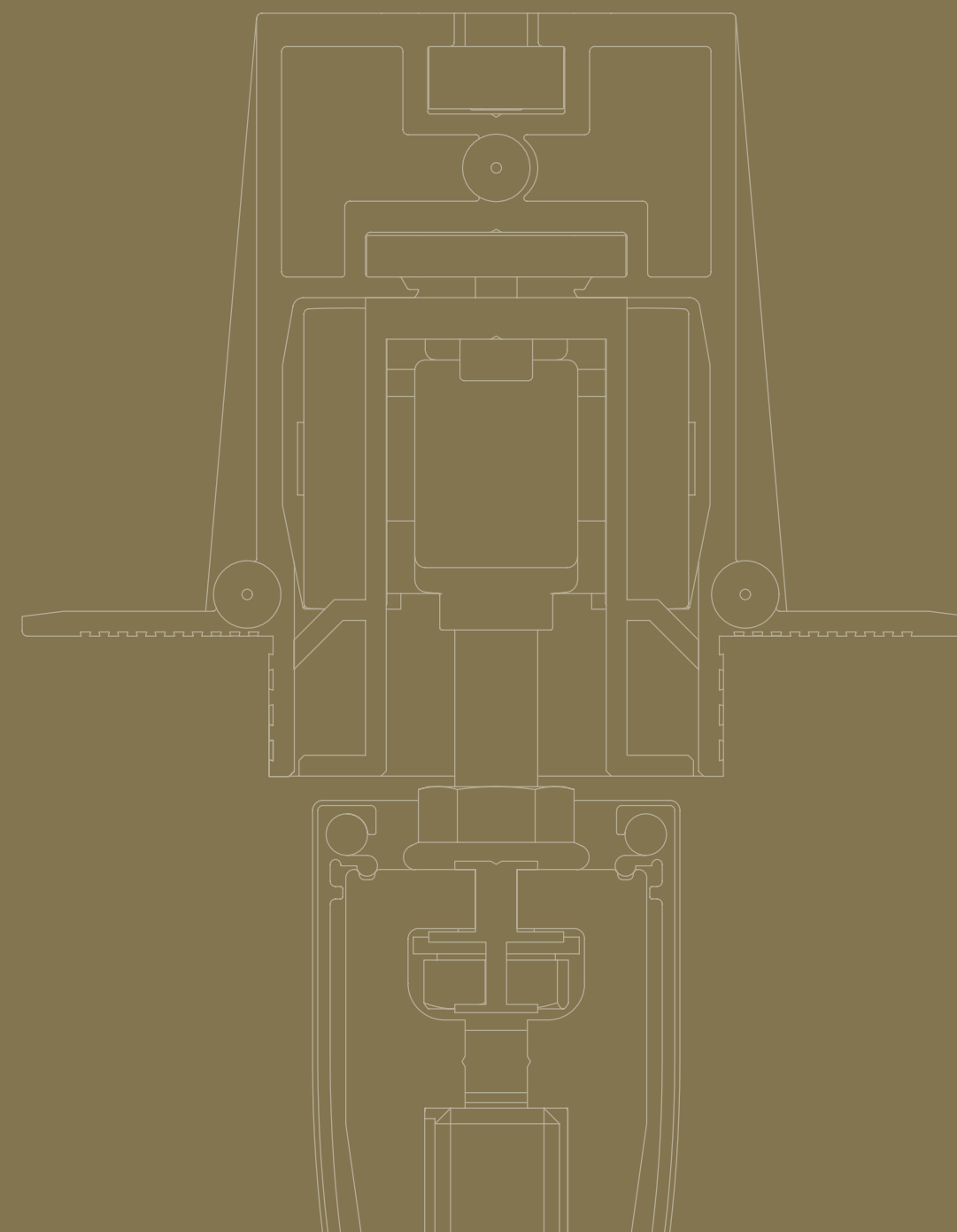



argenta
LATENT
 80 - 120 KG

Once this totally minimalist hardware has been installed, only a narrow gap remains visible. A small lid at the end of the track grants access to remove the wheel and any soft close without causing damage.

PROFILE LENGTH

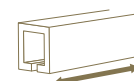

2 | 3 | 4 | 6 M

INSTALLATION



DOOR THICKNESS



DOOR WEIGHT



grey anodised
aluminium

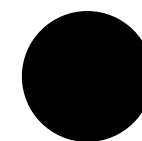

black anodised
aluminium

Technical drawings

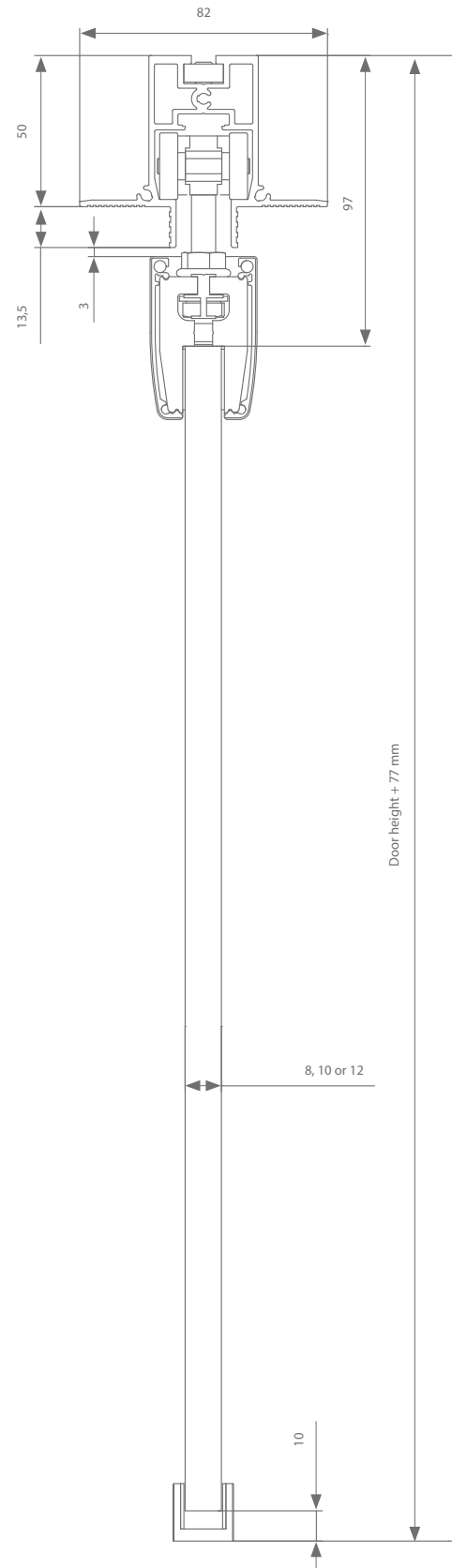

Height adjustment: + / - 3 mm

Tracks, profiles & covers

	Max. door width	Length	Reference
Running track Grey anodised aluminium	1000 mm	2000 mm	AK0.238.200
	1500 mm	3000 mm	AK0.238.300
	2000 mm	4000 mm	AK0.238.400
	3000 mm	6000 mm	AK0.238.600
Running track Black anodised aluminium	1000 mm	2000 mm	AK0.232.200
	1500 mm	3000 mm	AK0.232.300
	2000 mm	4000 mm	AK0.232.400
	3000 mm	6000 mm	AK0.232.600
Glass clamps cover profile	1000 mm	2000 mm	AK7.918.200
	1500 mm	3000 mm	AK7.918.300
	2000 mm	4000 mm	AK7.918.400
	3000 mm	6000 mm	AK7.918.600
End caps (2x):			
8 mm door thickness			AK9.978.008
10 mm door thickness			AK9.978.010
12 mm door thickness			AK9.978.012

Fitting Selection

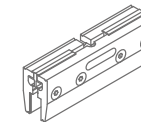

Single doors - Grey anodised aluminium	Reference
Without soft close	AK0.230.005
With 1 soft close (min. door width = 570 mm)	AK0.230.020.05
With double soft close (min. door width = 875 mm)	AK0.230.220.05
Single doors - Black anodised aluminium	
Without soft close	AK0.232.005
With 1 soft close (min. door width = 570 mm)	AK0.232.020.05
With double soft close (min. door width = 875 mm)	AK0.232.220.05
Double doors - Grey anodised aluminium*	
Without soft close	AK0.230.002.05
With 1 soft close (min. door width = 520 mm)	AK0.230.022.05
With double soft close (min. door width = 730 mm)	AK0.230.222.05
Double doors - Black anodised aluminium*	
Without soft close	AK0.232.002.05
With 1 soft close (min. door width = 520 mm)	AK0.232.022.05
With double soft close (min. door width = 730 mm)	AK0.232.222.05

Every fitting set comes with all the rollers or softclose mechanisms, suspension, guiding systems and stoppers you need.
*The glass used must always be hardened and meet safety standard EN 12150

Technical drawings

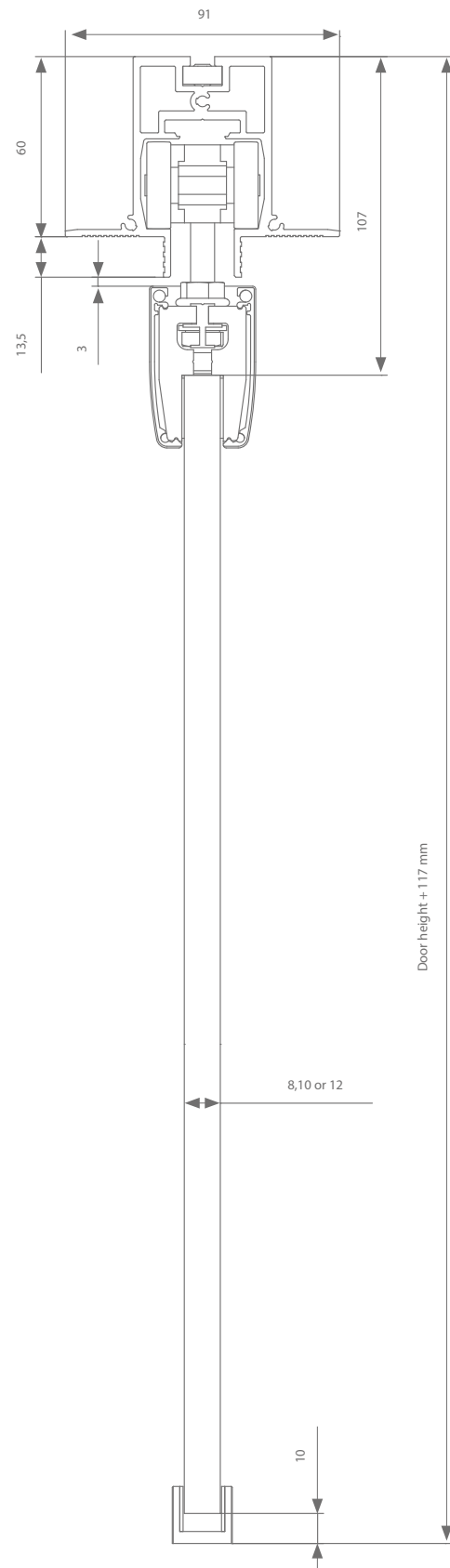

Height adjustment: + / - 5 mm

Tracks, profiles & covers

	Max. door width	Length	Reference
Running track Grey anodised aluminium	1000 mm	2000 mm	AM0.238.200
	1500 mm	3000 mm	AM0.238.300
	2000 mm	4000 mm	AM0.238.400
	3000 mm	6000 mm	AM0.238.600
Running track Black anodised aluminium	1000 mm	2000 mm	AM0.232.200
	1500 mm	3000 mm	AM0.232.300
	2000 mm	4000 mm	AM0.232.400
	3000 mm	6000 mm	AM0.232.600
Glass clamps cover profile	1000 mm	2000 mm	AK7.918.200
	1500 mm	3000 mm	AK7.918.300
	2000 mm	4000 mm	AK7.918.400
	3000 mm	6000 mm	AK7.918.600
End caps (2x):			
8 mm door thickness			AK9.978.008
10 mm door thickness			AK9.978.010
12 mm door thickness			AK9.978.012

Fitting Selection

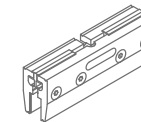

Single doors - Grey anodised aluminium	Reference
Without soft close	AM0.230.005
With 1 soft close (min. door width = 570 mm)	AM0.230.020.05
With double soft close (min. door width = 875 mm)	AM0.230.220.05
Single doors - Black anodised aluminium	
Without soft close	AM0.232.005
With 1 soft close (min. door width = 570 mm)	AM0.232.020.05
With double soft close (min. door width = 875 mm)	AM0.232.220.05
Double doors - Grey anodised aluminium*	
Without soft close	AM0.230.002.05
With 1 soft close (min. door width = 520 mm)	AM0.230.022.05
With double soft close (min. door width = 730 mm)	AM0.230.222.05
Double doors - Black anodised aluminium*	
Without soft close	AM0.232.002.05
With 1 soft close (min. door width = 520 mm)	AM0.232.022.05
With double soft close (min. door width = 730 mm)	AM0.232.222.05

Every fitting set comes with all the rollers or softclose mechanisms, suspension, guiding systems and stoppers you need.
*The glass used must always be hardened and meet safety standard EN 12150



06

HIDE GLASS

This minimalist sliding door system that fits into a 12.5 mm plasterboard suspended ceiling consists of a fixed recessed profile and a removable running track.

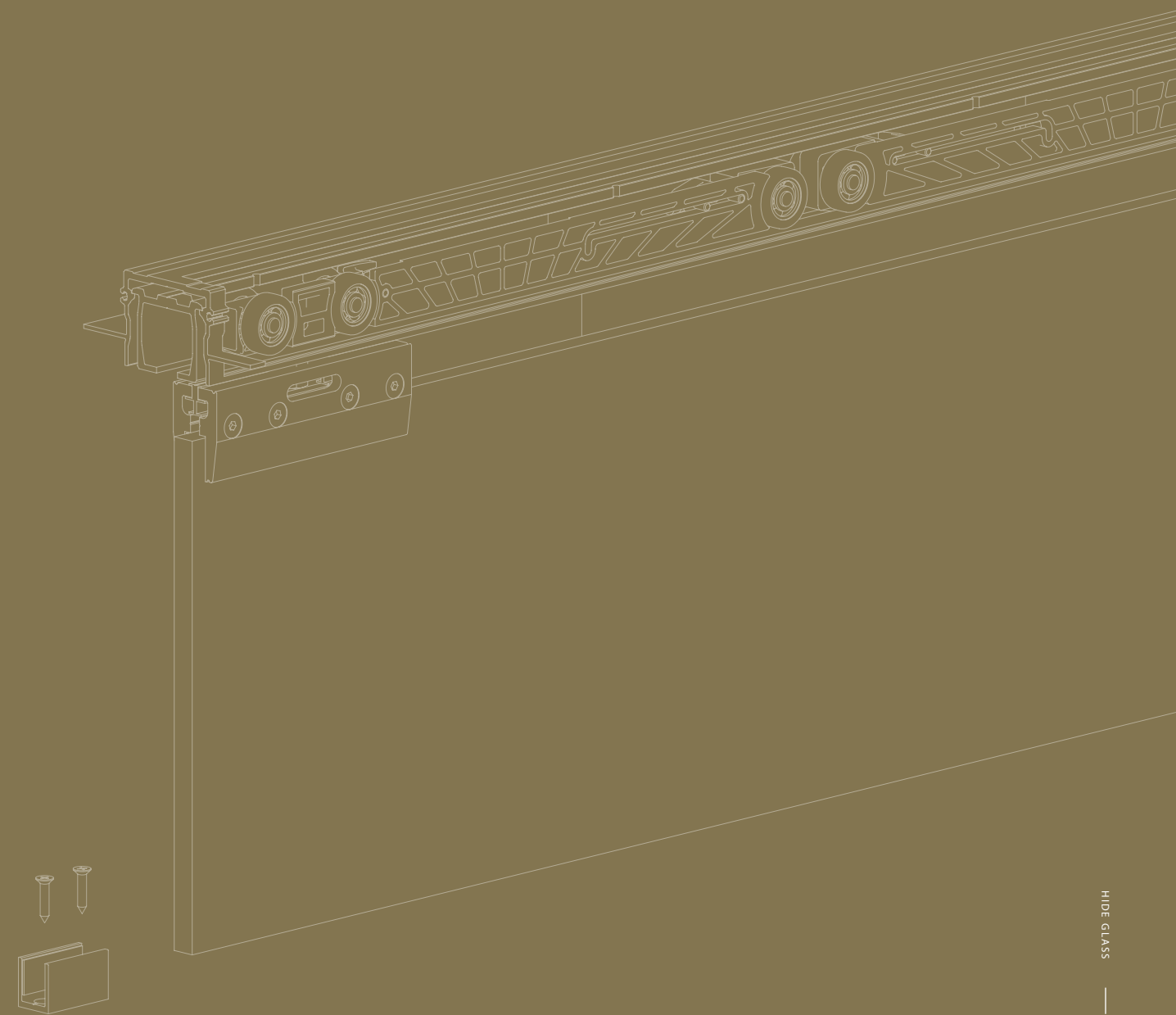



argenta
HIDE
 80 - 120 KG

This system is both discreet and user-friendly as the rollers, stoppers and soft closes remain accessible at all times.

PROFILE LENGTH

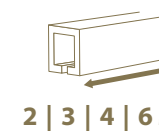

2 | 3 | 4 | 6 M

INSTALLATION

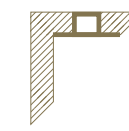

DOOR THICKNESS



8
10
12
MM

DOOR WEIGHT



MAX.
120
KG



anodised
aluminium

argenta hide 80 kg
ceiling mount

assemble your set 

Technical drawing

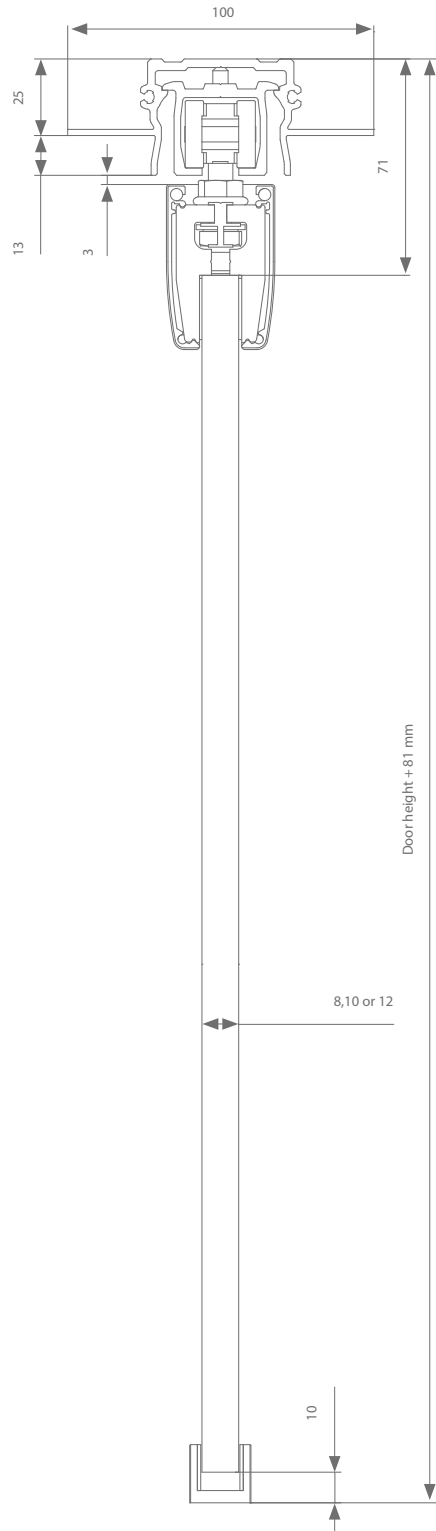

Tracks, profiles & covers

	Max. door width	Length	Reference
Running track	1000 mm	2000 mm	AK0.288.200
	1500 mm	3000 mm	AK0.288.300
	2000 mm	4000 mm	AK0.288.400
	3000 mm	6000 mm	AK0.288.600
Glass clamps cover profile	1000 mm	2000 mm	AK7.918.200
	1500 mm	3000 mm	AK7.918.300
	2000 mm	4000 mm	AK7.918.400
	3000 mm	6000 mm	AK7.918.600
End caps (2x):			
8mm door thickness			AK9.978.008
10mm door thickness			AK9.978.010
12mm door thickness			AK9.978.012

Fitting Selection

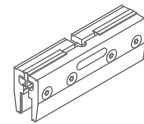

Transverse suspension	Reference
Without soft close	AK0.500.080
With 1 soft close (min. door width = 502 mm)	AK0.500.080.20
With double soft close (min. door width = 739 mm)	AK0.500.082.20

Every fitting set comes with all the rollers or softclose mechanisms, suspension, guiding systems and stoppers you need.

Height adjustment: +/- 3 mm

*The glass used must always be hardened and meet safety standard EN 12150

argenta hide 120 kg
ceiling mount

assemble your set 

Technical drawing

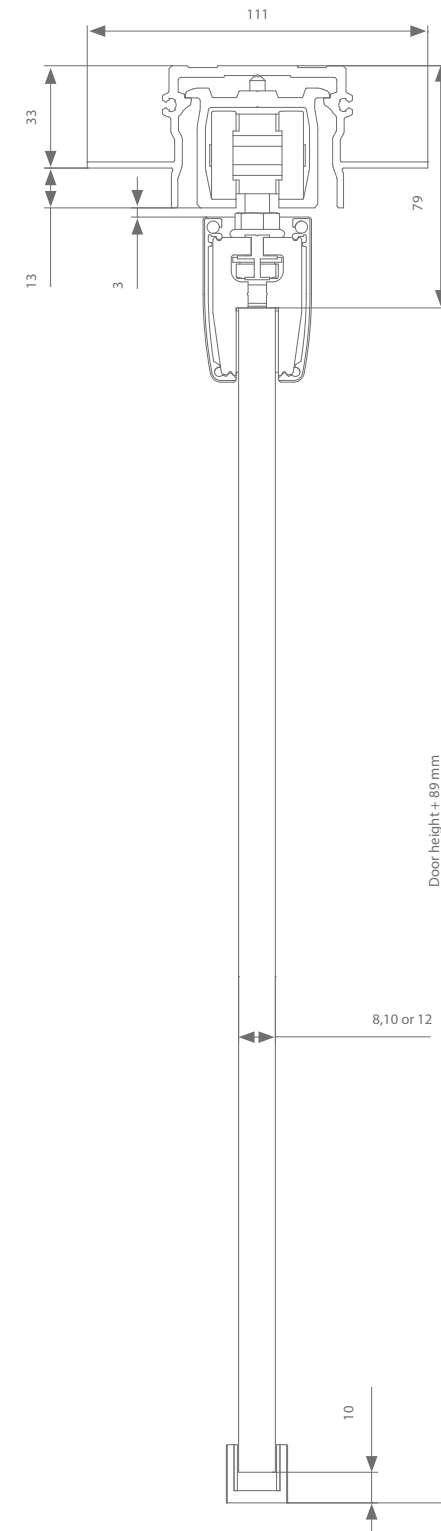

Tracks, profiles & covers

	Max. door width	Length	Reference
Running track	1000 mm	2000 mm	AM0.288.200
	1500 mm	3000 mm	AM0.288.300
	2000 mm	4000 mm	AM0.288.400
	3000 mm	6000 mm	AM0.288.600
Glass clamps cover profile	1000 mm	2000 mm	AK7.918.200
	1500 mm	3000 mm	AK7.918.300
	2000 mm	4000 mm	AK7.918.400
	3000 mm	6000 mm	AK7.918.600
End caps (2x):			
8mm door thickness			AK9.978.008
10mm door thickness			AK9.978.010
12mm door thickness			AK9.978.012

Fitting Selection

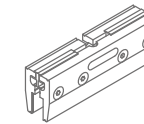

Transverse suspension	Reference
Without soft close	AM0.500
With 1 soft close (min. door width = 502 mm)	AM0.500.020
With double soft close (min. door width = 739 mm)	AM0.500.220

Every fitting set comes with all the rollers or softclose mechanisms, suspension, guiding systems and stoppers you need.

Height adjustment: +/- 5 mm

*The glass used must always be hardened and meet safety standard EN 12150



07

EXPERT SYMMETRICAL GLASS

The telescopic system makes it perfectly possible to divide rooms using 2 door panels that are compactly parked together alongside a narrow wall.

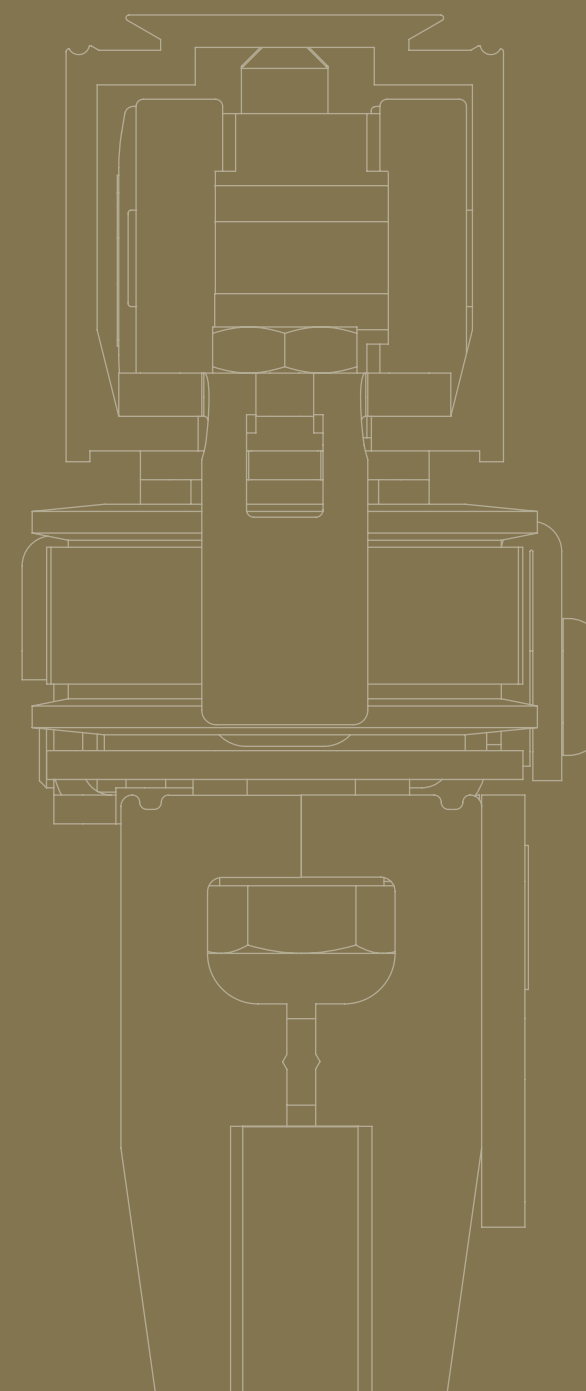



argenta
EXPERT SYMMETRICAL
 80 KG

A belt tensioner ensures everything is perfectly configured for the best possible operation. A belt balancer prevents the belt from sagging in track lengths over 4 m.

PROFILE LENGTH

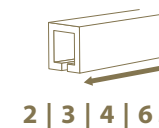

2 | 3 | 4 | 6 M

INSTALLATION



DOOR THICKNESS



8
10
12
MM

DOOR WEIGHT

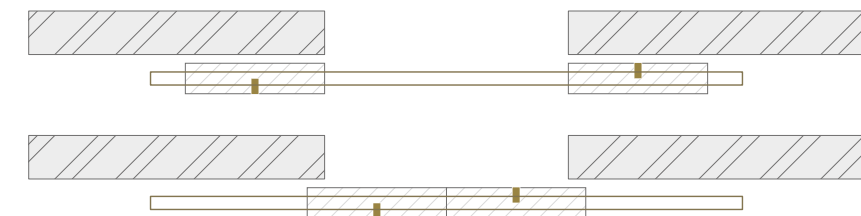

anodised
aluminium

Technical drawing

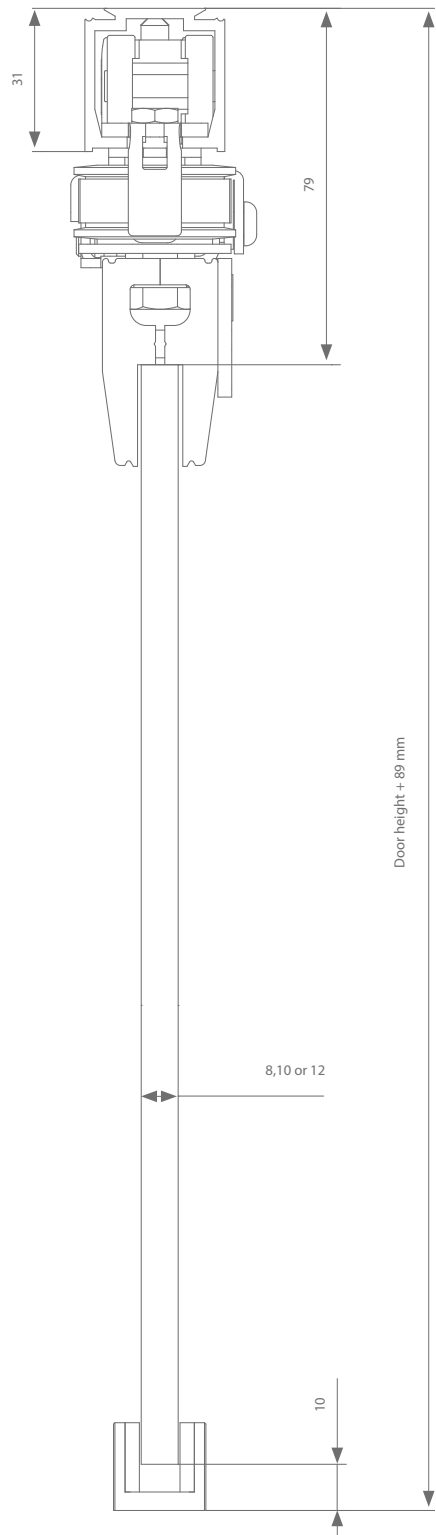

Tracks

	Max. door width	Length	Reference
Running track	500 mm	2000 mm	AK0.208.200
	750 mm	3000 mm	AK0.208.300
	1000 mm	4000 mm*	AK0.208.400*
	1500 mm	6000 mm*	AK0.208.600*

Fitting Selection

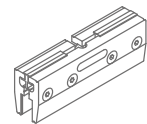

Transverse suspension	Reference
-----------------------	-----------

Without soft close AK0.701.005

Every fitting set comes with all the rollers, suspension, guiding systems and stoppers you need.

Belt

	Length	Reference
Min. belt length = (4 x door width) x 2 + 200 mm	50 m	AK9.709.050
	20 m	AK9.709.020
	10 m	AK9.709.010

*Belt balancer (prevents belt sagging)

Track length > 4000 mm

AK0.741.1

Height adjustment: +/- 3 mm Min. clearance = 2100 mm - Max. clearance = 2900 mm

*The glass used must always be hardened and meet safety standard EN 12150

Technical drawing

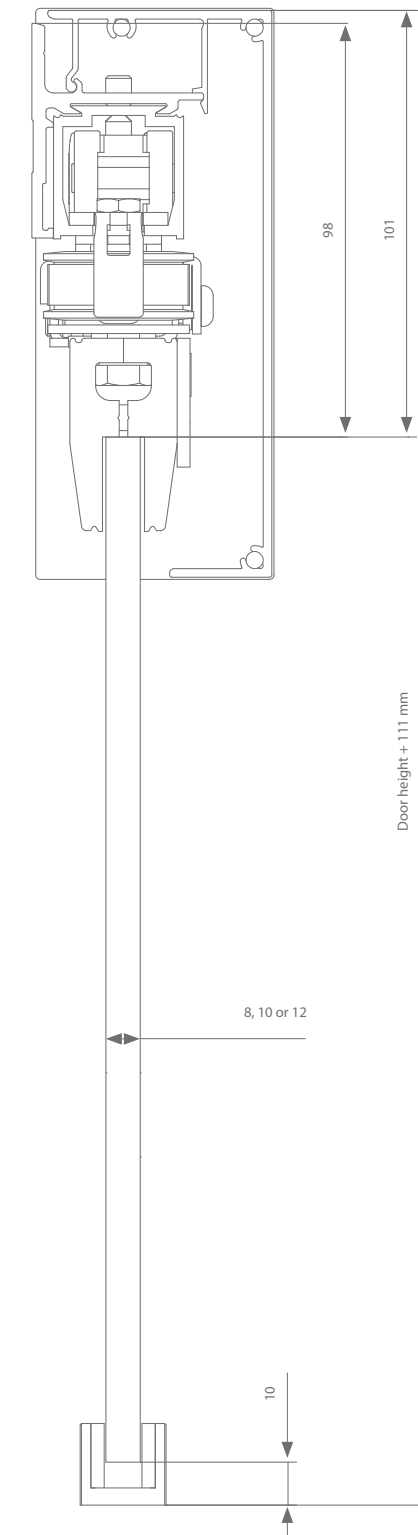

Tracks, profiles & covers

	Max. door width	Length	Reference
Running track	500 mm	2000 mm	AK0.208.200
	750 mm	3000 mm	AK0.208.300
	1000 mm	4000 mm*	AK0.208.400*
	1500 mm	6000 mm*	AK0.208.600*
Wall bracket	Required every 500 - 600 mm		AK1.148.0
Cover profile	500 mm	2000 mm	AK9.758.200
	750 mm	3000 mm	AK9.758.300
	1000 mm	4000 mm	AK9.758.400
	1500 mm	6000 mm	AK9.758.600
+ end caps			AK3.968

Fitting Selection

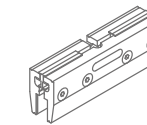

Transverse suspension	Reference
-----------------------	-----------

Without soft close AK0.701.005

Every fitting set comes with all the rollers, suspension, guiding systems and stoppers you need.

Belt

	Length	Reference
Min. belt length = (4 x door width) x 2 + 200 mm	50 m	AK9.709.050
	20 m	AK9.709.020
	10 m	AK9.709.010

*Belt balancer (prevents belt sagging)

Track length > 4000 mm

AK0.741.1

Height adjustment: +/- 3 mm Min. clearance = 1200 mm - Max. clearance = 2900 mm

*The glass used must always be hardened and meet safety standard EN 12150



08

EXPERT TELESCOPIC GLASS

The telescopic system makes it perfectly possible to divide rooms using 2 door panels that are compactly bundled together along a narrow wall.

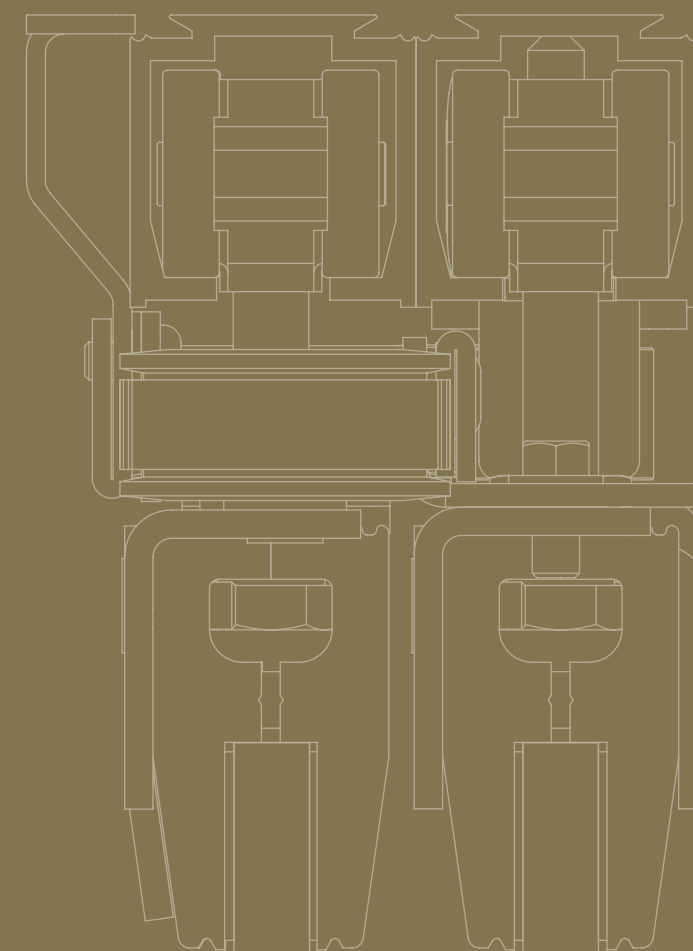



argenta
EXPERT TELESCOPIC
 80 KG

In the belt version, all doors move simultaneously so that they reach their end point at the same time. A reinforced belt is joined to the door and tensioned using a belt tensioner.

Proper belt tension is required for optimal operation.

PROFILE LENGTH

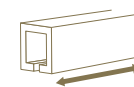

2 | 3 | 4 | 6 M

INSTALLATION



DOOR THICKNESS



8
10
12
MM

DOOR WEIGHT

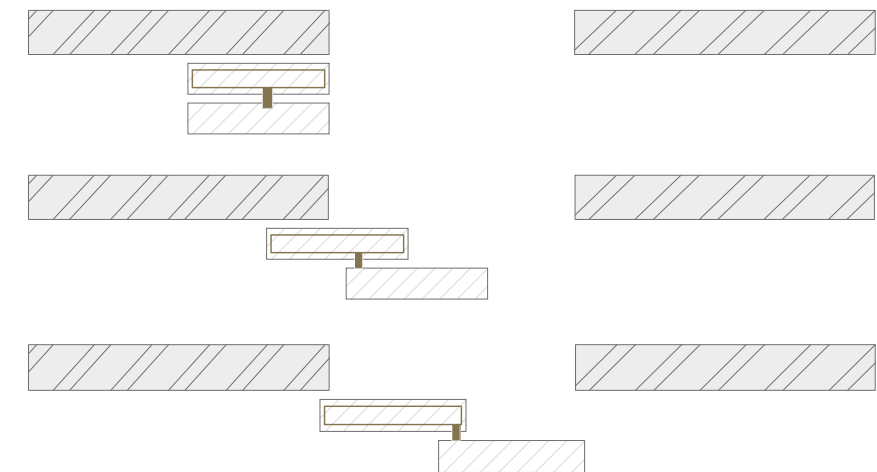

anodised
aluminium

Technical drawings

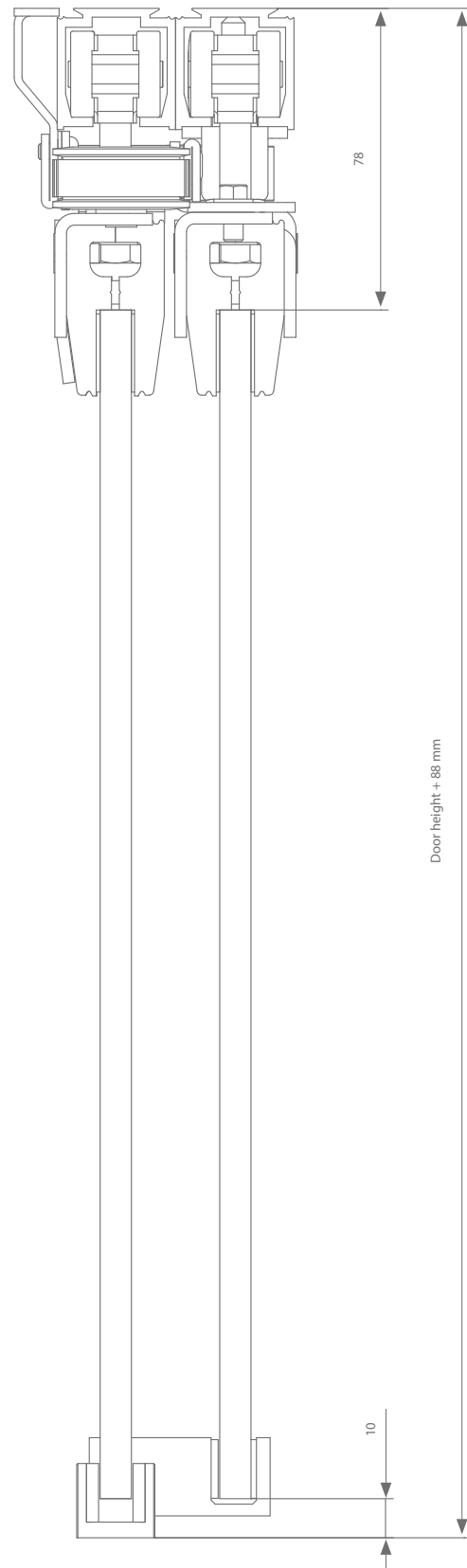

Height adjustment: + / - 3 mm
Min. clearance = 1120 mm - Max. clearance = 3900 mm

Tracks

	Max. door width	Length	Reference
Running track	667 mm	2000 mm	AK0.208.200
	1000 mm	3000 mm	AK0.208.300
	1334 mm	4000 mm	AK0.208.400
	2000 mm	6000 mm	AK0.208.600

Fitting Selection

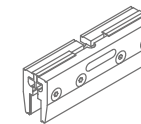

Transverse suspension	Reference
Without soft close	AK0.801.005
Bottom guiding channel	Reference
8 mm door thickness	AK0.800.408.05
10 mm door thickness	AK0.800.410.05
12 mm door thickness	AK0.800.412.05









Every fitting set comes with all the rollers, suspension, guiding systems and stoppers you need.

Belt

	Length	Reference
Min. belt length = (2 x door width) + 400 mm	50 m	AK9.709.050
	20 m	AK9.709.020
	10 m	AK9.709.010

*The glass used must always be hardened and meet safety standard EN 12150

PRODUCT CONFIGURATOR GLASS

Order sequence	40 kg	80 kg	80 kg S	120 kg	
1 Running track					
	2 m	AG0.208.200	AK0.208.200	AK0.208.200	AM0.208.200
	3 m	AG0.208.300	AK0.208.300	AK0.208.300	AM0.208.300
	4 m	AG0.208.400	AK0.208.400	AK0.208.400	AM0.208.400
	6 m	AG0.208.600	AK0.208.600	AK0.208.600	AM0.208.600
Ceiling mount	Not necessary	Not necessary	Not necessary	Not necessary	
2 Cover profile					
	2 m	AK0.928.200	AK0.928.200	AK0.928.200	AM0.928.200
	3 m	AK0.928.300	AK0.928.300	AK0.928.300	AM0.928.300
	4 m	AK0.928.400	AK0.928.400	AK0.928.400	AM0.928.400
	6 m	AK0.928.600	AK0.928.600	AK0.928.600	AM0.928.600
+ Set of covers	AK9.958	AK9.958	AK9.958	AM9.958	
3 Wall mount: Wall bracket					
	2 m	AK7.918.200	AK7.918.200	AK7.918.200	AK7.918.200
	3 m	AK7.918.300	AK7.918.300	AK7.918.300	AK7.918.300
	4 m	AK7.918.400	AK7.918.400	AK7.918.400	AK7.918.400
	6 m	AK7.918.600	AK7.918.600	AK7.918.600	AK7.918.600
+ Set of covers					
4 Fittings*	Door thickness 8 mm	AK9.978.008	AK9.978.008	AK9.978.008	AK9.978.008
	Door thickness 10 mm	AK9.978.010	AK9.978.010	AK9.978.010	AK9.978.010
	Door thickness 12 mm	AK9.978.012	AK9.978.012	AK9.978.012	AK9.978.012
	To be fitted every 50 - 60 cm				
		AK1.118.0	AK1.118.0	AK1.118.0	AM1.118.0
4 Fittings*					
	Without soft close	AG0.500	AK0.500	AK0.500.080	AM0.500
	With 1 soft close	AG0.500.020	AK0.500.020	AK0.500.080.20	AM0.500.020
With double soft close	AG0.500.220	/	AK0.500.082.20	AM0.500.220	

*Fittings always come with all rollers/soft close systems, suspension brackets, bottom guiding channel and all small accessories. An activator is provided with all soft closes. A stopper is provided with all rollers.

Minimum door width

	1 soft close	2 soft closes
Expert 40 - 80 kg	502 mm	739 mm
Expert 120 kg	553 mm	789 mm



Ter Vlucht 2 +32 (0)51 27 05 00
8850 Ardoonie info@arlu.be
Belgium WWW.ARLU.BE



©L3000026 10/24 English