



EXPERT

TIMBER





01

EXPERT TIMBER

- 6 expert 40 kg
- 14 expert 80 kg
- 22 expert 80 kg superior
- 30 expert 120 kg
- 36 expert 200 kg
- 40 total sets 40-120 kg
- 42 autoclose
- 44 unislide

02

CUBE TIMBER

- 48 cube 40 - 80 kg
- 52 cube steel door
- 56 total sets 80 kg

03

LATENT TIMBER

- 58 latent 80 - 120 kg

04

HIDE TIMBER

- 66 hide 80 - 120 kg

05

SYMMETRICAL

- 72 symmetric 80-120 kg

06

TELESCOPIC

- 80 telescopic 80 kg

07

FOLD

- 88 fold 80 kg

08

PRODUCT CONFIGURATOR

EXPERT TIMBER

ARLU® launched its expert range for interior applications to much acclaim some time ago. Countless references back up the fact that this high-quality hardware has since become an established name within the argenta range. Expert offers added value in terms of quality, and an extremely long lifespan (min. 100,000 cycles) comes guaranteed.

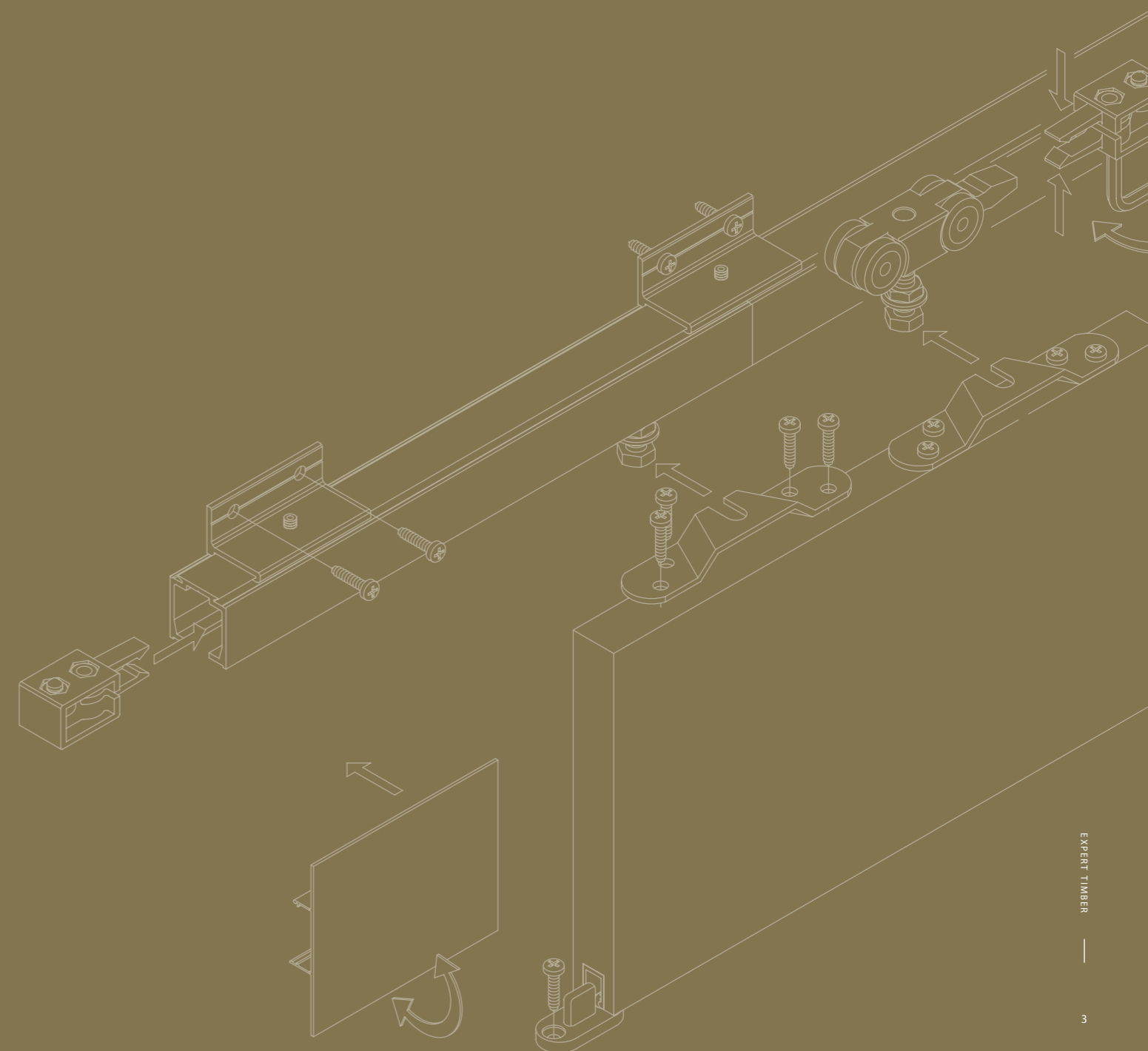

ARLU, THE REFERENCE FOR OPENING DOORS

ARLU® is the manufacturer behind the brand names argenta® and rob®. Argenta has been a leading brand in door hardware for over 100 years, but today it is mainly synonymous with invisible door systems.

Minimalist architecture swears by clean lines and a "back to the essence" mentality. In terms of interior doors, this results in integrated door fittings, invisible integrated techniques, door frames and skirting boards for revolving, sliding and pivoting doors

Argenta stands for a full range of sleek interior solutions.



argenta expert timber
general information

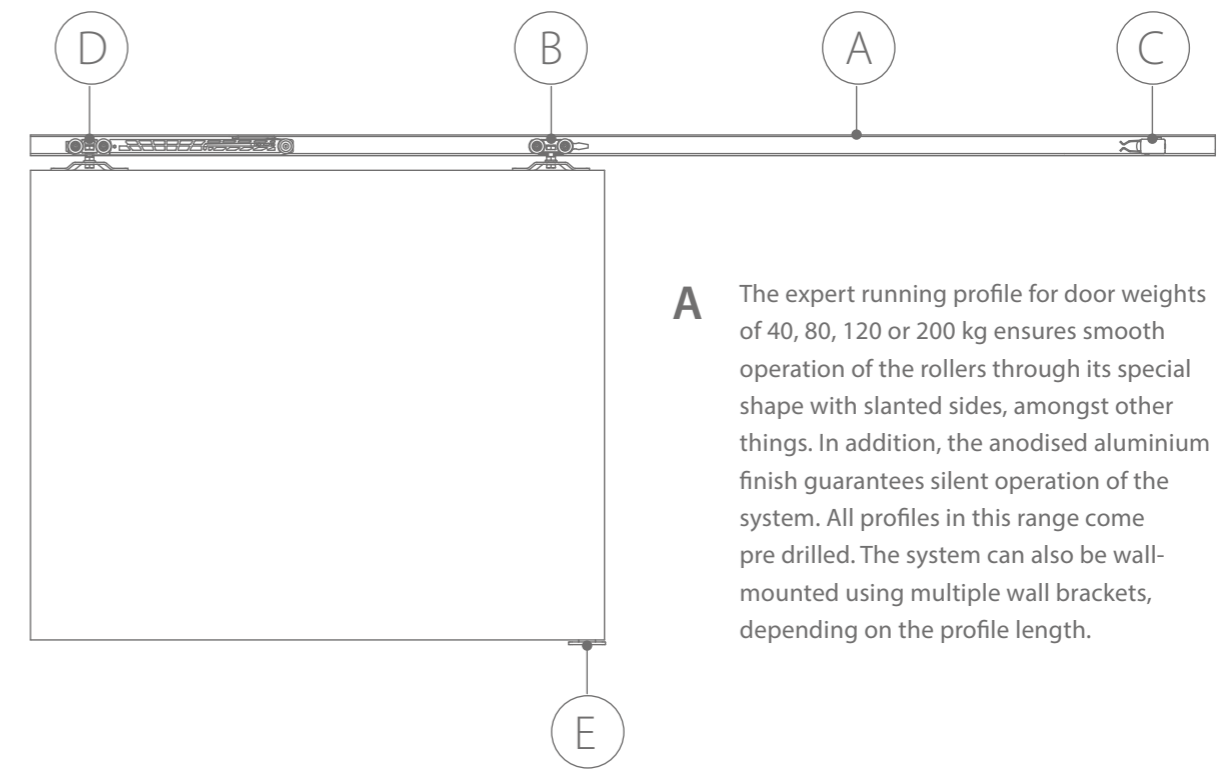

A The expert running profile for door weights of 40, 80, 120 or 200 kg ensures smooth operation of the rollers through its special shape with slanted sides, amongst other things. In addition, the anodised aluminium finish guarantees silent operation of the system. All profiles in this range come pre drilled. The system can also be wall-mounted using multiple wall brackets, depending on the profile length.

B The ball-bearing rollers guarantee light and silent operation of the sliding door. A superior UPVC roller with additional superior-quality ball bearings has been created for the 80, 120 and 200 kg range.

C When the door reaches its end position, the roller is caught by the stopper, which keeps the door in its open or closed position. The stopper is easy to move and its clamping strength can be adjusted. The 80 kg superior stopper is fitted with an extra-strong stainless steel spring clamp that guarantees a longer lifespan.

D Expert offers the possibility to choose a softclose/softopen system for smooth and secure door closing or opening without any impact on the wall. This option is also recommended as finger protection for children. Just like the rollers, the softclose system is fitted with ball bearings in each wheel for doors of up to 40, 80 or 120 kg.

E A suitable bottom guiding system is required for smooth and straight operation of the door panel. To ensure this is the case, expert provides a guiding channel profile to be milled into the bottom of the door panel, combined with a UPVC floor guiding channel. This bottom guiding channel can also prevent any deformation of the door panel.



argenta
EXPERT
40 KG

Expert allows light sliding doors of up to 40 kg to be moved without any irritating noise or vibration. Both thin and thick panels can be fitted with this system, with or without 1 or 2 softcloses. The door panel can be fitted to the rollers with suspension plates; a cover profile and endcaps provide the perfect finish in both wall-mounted and ceiling-mounted situations. For a more discrete finish, a compact version is available that limits the fitting dimensions and provides a clearance of only 3 mm between the door and the profile.

PROFILE LENGTH

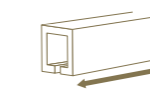

2 | 3 | 4 | 6 M

INSTALLATION



DOOR WEIGHT

MAX.
40
KG



anodised
aluminium

Technical drawings

Version A

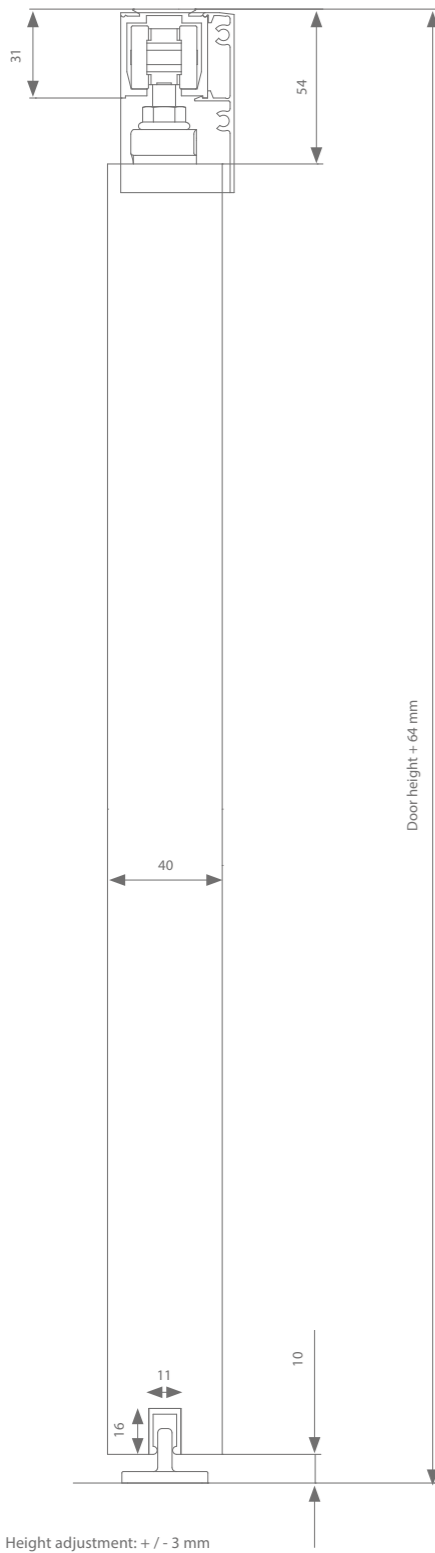

Version B

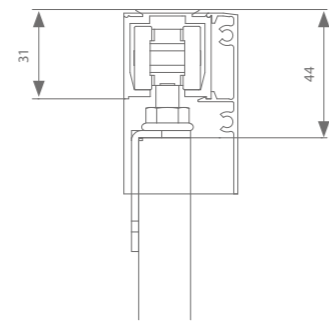

TIP



The AK9.335 guide is ideal in situations where you prefer not to fix the guiding channel to the floor.

Profiles

	Max. door width	Length	Reference
Running track	1000 mm	2000 mm	AG0.208.200
	1500 mm	3000 mm	AG0.208.300
	2000 mm	4000 mm	AG0.208.400
	3000 mm	6000 mm	AG0.208.600
Cover profile	1000 mm	2000 mm	AK0.948.200
	1500 mm	3000 mm	AK0.948.300
	2000 mm	4000 mm	AK0.948.400
	3000 mm	6000 mm	AK0.948.600
+ end caps			AK9.948
Guiding track	1000 mm	1000 mm	510.608.100
	1250 mm	1250 mm	510.608.125
	1500 mm	1500 mm	510.608.150
	2000 mm	2000 mm	510.608.200
	3000 mm	3000 mm	510.608.300

Fittings selection

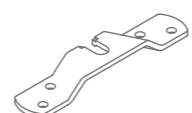
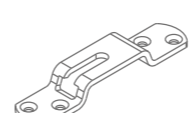
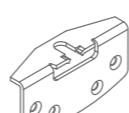
	Reference
Transverse suspension (version A)	
 Without softclose	AG0.100
With 1 softclose (min. door width = 494 mm)	AG0.100.020
With 2 softcloses (min. door width = 724 mm)	AG0.100.220
Lateral suspension (version A)	
 Without softclose	AG0.106
Thin panels with 18 - 38 mm door thickness (version B)	
 Without softclose	AG0.102
With 1 softclose (min. door width = 494 mm)	AG0.102.020
With 2 softcloses (min. door width = 724 mm)	AG0.102.220

Every fitting set comes with all the rollers or softclose mechanisms, suspension, guiding systems and stoppers you need.
* If the distance between the wall and door is at least 13 mm, Autoclose (p. 42) is an option for automatic door closure.

Technical drawings

Option 1 - Version A

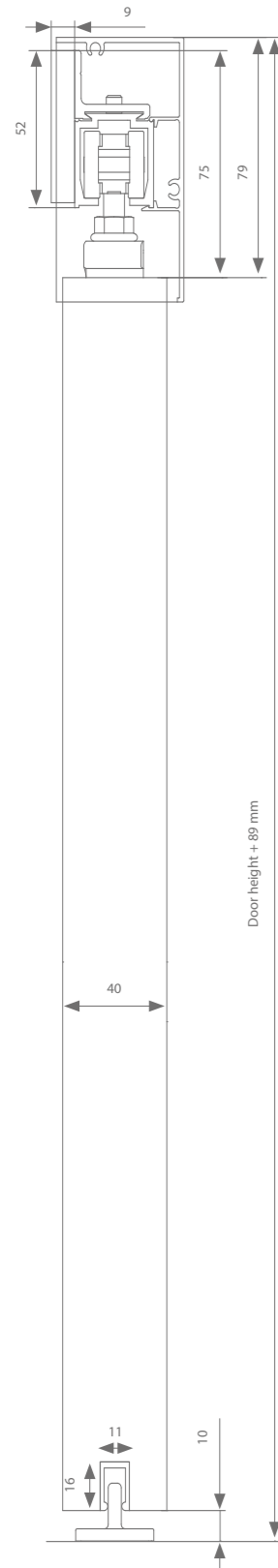

Option 1 - Version B

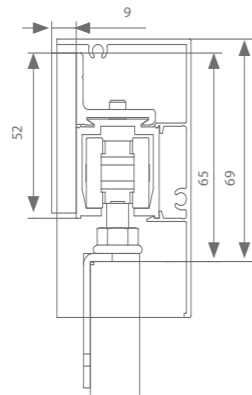

Option 1 - Version C



Option 2 - Version A

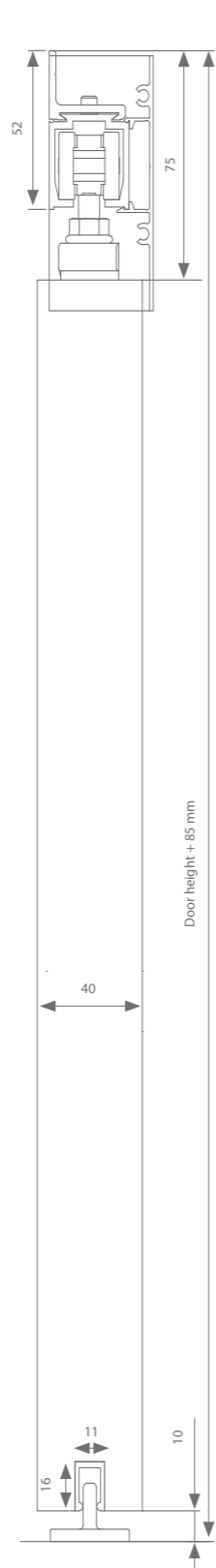

Option 2 - Version B

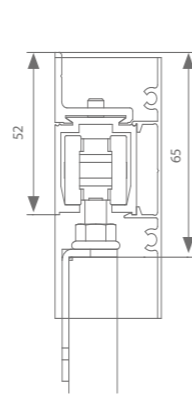

Option 2 - Version C



TIP

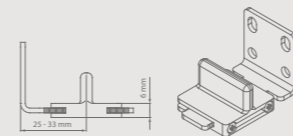

The AK9.335 guide is ideal in situations where you prefer not to fix the guiding channel to the floor.

Profiles

	Max. door width	Length	Reference
Running track	1000 mm	2000 mm	AG0.208.200
	1500 mm	3000 mm	AG0.208.300
	2000 mm	4000 mm	AG0.208.400
	3000 mm	6000 mm	AG0.208.600
Wall bracket	Required every 500 - 600 mm		AK1.118.0
Cover profile (optie 1)	1000 mm	2000 mm	AK9.708.200
	1500 mm	3000 mm	AK9.708.300
	2000 mm	4000 mm	AK9.708.400
	3000 mm	6000 mm	AK9.708.600
+ end caps			AK9.708
Cover profile (optie 2)	1000 mm	2000 mm	AK0.938.200
	1500 mm	3000 mm	AK0.938.300
	2000 mm	4000 mm	AK0.938.400
	3000 mm	6000 mm	AK0.938.600
+ end caps			AK9.938
Guiding track	1000 mm	1000 mm	510.608.100
	1250 mm	1250 mm	510.608.125
	1500 mm	1500 mm	510.608.150
	2000 mm	2000 mm	510.608.200
	3000 mm	3000 mm	510.608.300

Fittings selection

	Reference
Transverse suspension (version A)	
Without softclose	AG0.100
With 1 softclose (min. door width = 494 mm)	AG0.100.020*
With 2 softcloses (min. door width = 724 mm)	AG0.100.220
Lateral suspension (version A)	
Without softclose	AG0.106
Thin panels with 18 - 38 mm door thickness (version B)	
Without softclose	AG0.102
With 1 softclose (min. door width = 494 mm)	AG0.102.020
With 2 softcloses (min. door width = 724 mm)	AG0.102.220

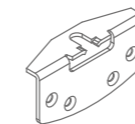
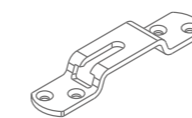
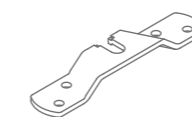

Every fitting set comes with all the rollers or softclose mechanisms, suspension, guiding systems and stoppers you need.
* If the distance between the wall and door is at least 13 mm, Autoclose (p. 42) is an option for automatic door closure.

Technical drawing

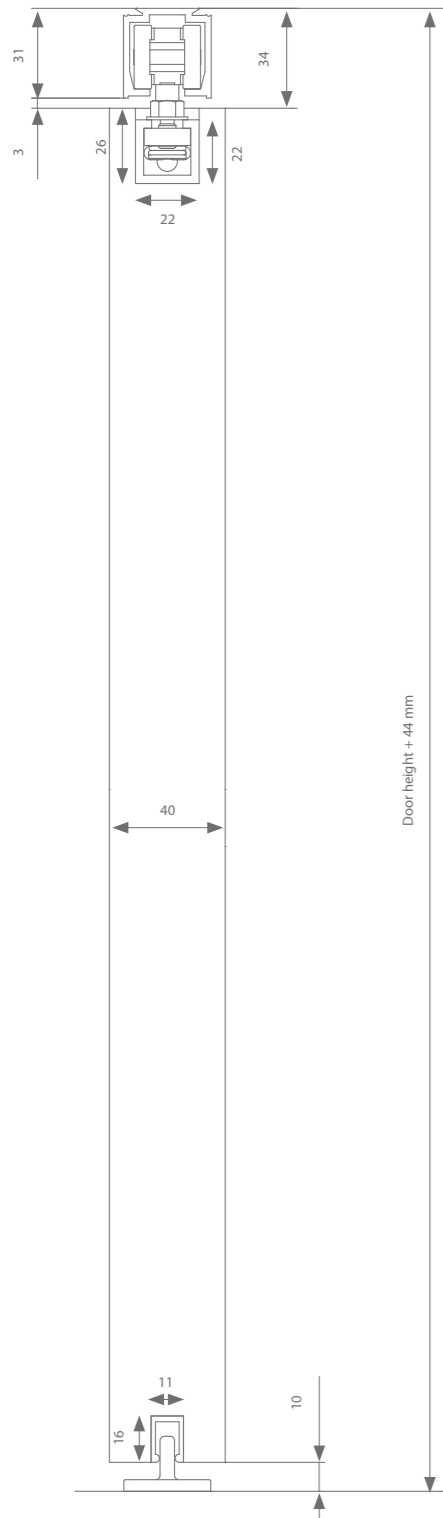

Height adjustment: + 0 / - 5 mm

Profiles

	Max. door width	Length	Reference
Running track	1000 mm	2000 mm	AG0.208.200
	1500 mm	3000 mm	AG0.208.300
	2000 mm	4000 mm	AG0.208.400
	3000 mm	6000 mm	AG0.208.600
Suspension profile		236 mm	(2x) 110.828
	1000 mm	1000 mm	110.828.100
	1250 mm	1250 mm	110.828.125
	1500 mm	1500 mm	110.828.150
	2000 mm	2000 mm	110.828.200
+ end caps			(2x) 110.829
	3000 mm	3000 mm	110.828.300
Guiding track	1000 mm	1000 mm	510.608.100
	1250 mm	1250 mm	510.608.125
	1500 mm	1500 mm	510.608.150
	2000 mm	2000 mm	510.608.200
	3000 mm	3000 mm	510.608.300

Fittings selection

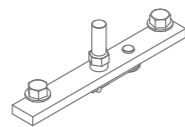

Compact suspension	Reference
Without softclose	AG0.308
With 1 softclose (min. door width = 502 mm)	AG0.308.020
With 2 softcloses (min. door width = 737 mm)	AG0.308.220

Every fitting set comes with all the rollers or softclose mechanisms, suspension, guiding systems and stoppers you need.

TIP

The AK9.335 guide is ideal in situations where you prefer not to fix the guiding channel to the floor.

Technical drawing

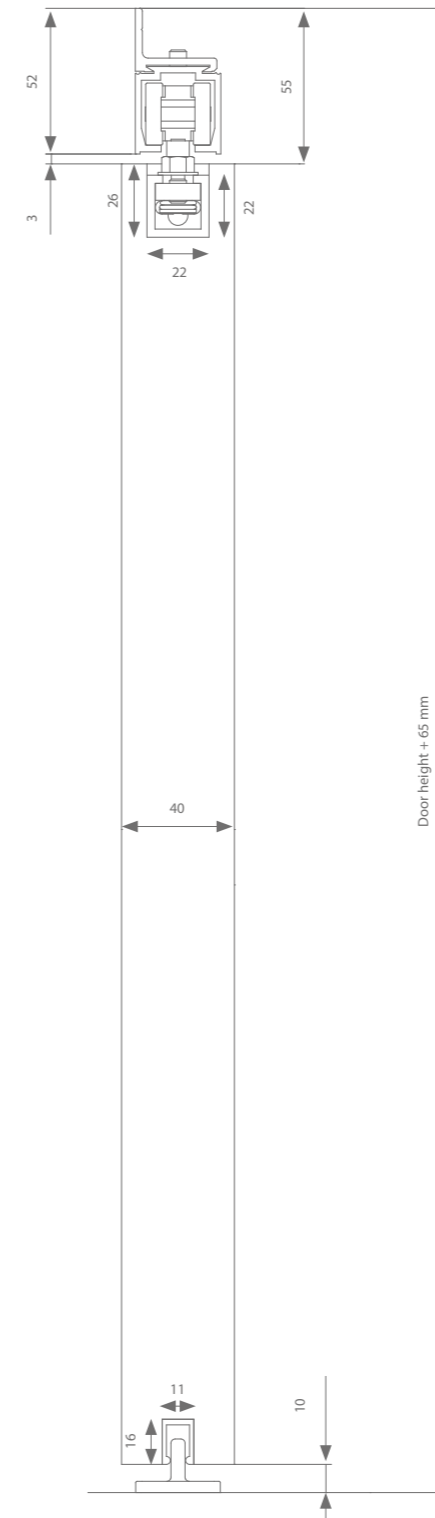

Height adjustment: + 0 / - 5 mm

Profiles

	Max. door width	Length	Reference
Running track	1000 mm	2000 mm	AG0.208.200
	1500 mm	3000 mm	AG0.208.300
	2000 mm	4000 mm	AG0.208.400
	3000 mm	6000 mm	AG0.208.600
Wall bracket	Required every 500 - 600 mm		AK1.118.0
Suspension profile		236 mm	(2x) 110.828
	1000 mm	1000 mm	110.828.100
	1250 mm	1250 mm	110.828.125
	1500 mm	1500 mm	110.828.150
	2000 mm	2000 mm	110.828.200
+ end caps			(2x) 110.829
	3000 mm	3000 mm	110.828.300
Guiding track	1000 mm	1000 mm	510.608.100
	1250 mm	1250 mm	510.608.125
	1500 mm	1500 mm	510.608.150
	2000 mm	2000 mm	510.608.200
	3000 mm	3000 mm	510.608.300

Fittings selection

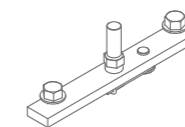

Compact suspension	Reference
Without softclose	AG0.308
With 1 softclose (min. door width = 502 mm)	AG0.308.020
With 2 softcloses (min. door width = 737 mm)	AG0.308.220

Every fitting set comes with all the rollers or softclose mechanisms, suspension, guiding systems and stoppers you need.

TIP

The AK9.335 guide is ideal in situations where you prefer not to fix the guiding channel to the floor.



argenta
EXPERT
80 KG

This sliding door hardware moves doors of up to 80 kg in the most silent way possible. Both thin and thick panels can be fitted with this system, with or without 1 or 2 softcloses. The correct bottom guiding system ensures that the door remains perpendicular at all times. As with the 40 kg series, either suspension plates or a compact version are available for hanging the door panel (see page 7).

PROFILE LENGTH

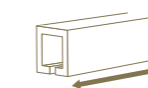

2 | 3 | 4 | 6 M

INSTALLATION



DOOR WEIGHT



anodised
aluminium

Technical drawings

Version A

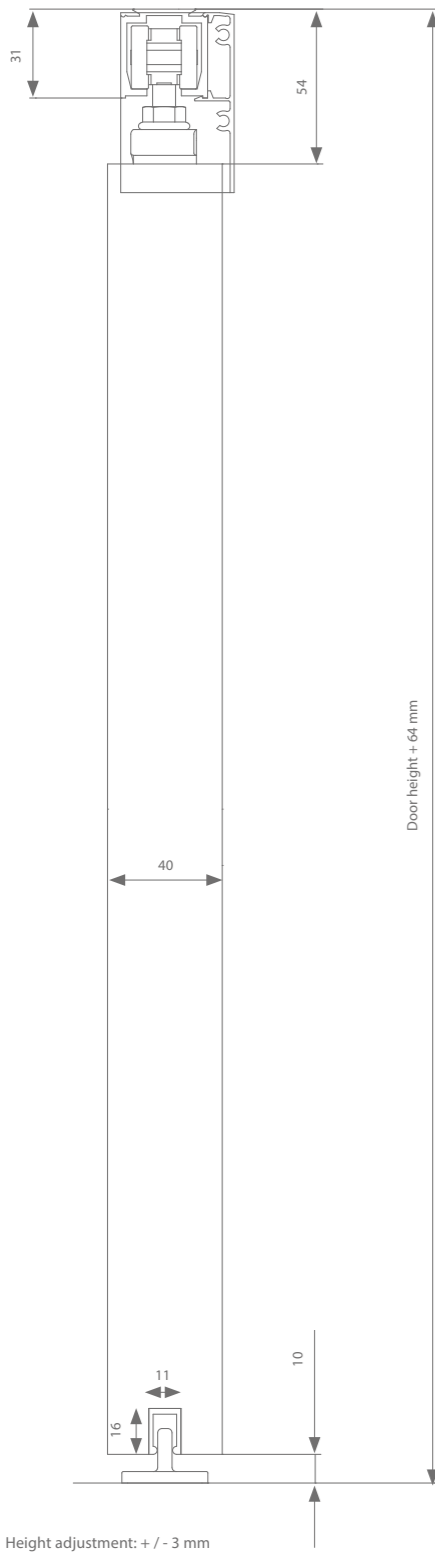

Version B

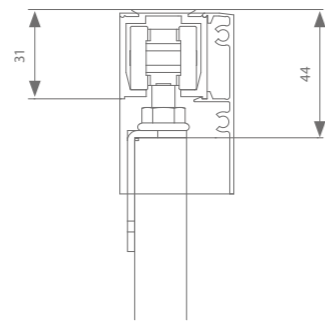

Profiles

	Max. door width	Length	Reference
Running track	1000 mm	2000 mm	AK0.208.200
	1500 mm	3000 mm	AK0.208.300
	2000 mm	4000 mm	AK0.208.400
	3000 mm	6000 mm	AK0.208.600
Cover profile	1000 mm	2000 mm	AK0.948.200
	1500 mm	3000 mm	AK0.948.300
	2000 mm	4000 mm	AK0.948.400
	3000 mm	6000 mm	AK0.948.600
+ end caps			AK9.948
Guiding track	1000 mm	1000 mm	510.608.100
	1250 mm	1250 mm	510.608.125
	1500 mm	1500 mm	510.608.150
	2000 mm	2000 mm	510.608.200
	3000 mm	3000 mm	510.608.300

Fittings selection

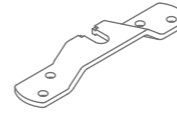
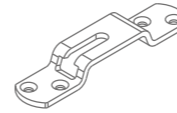
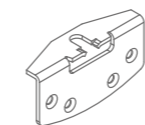
	Reference
Transverse suspension (version A)	
 Without softclose	AK0.100
With 1 softclose (min. door width = 494 mm)	AK0.100.020
Lateral suspension (version A)	
 Without softclose	AK0.106
Thin panels with 18 - 38 mm door thickness (version B)	
 Without softclose	AK0.102
With 1 softclose (min. door width = 494 mm)	AK0.102.020
With 2 softcloses (min. door width = 724 mm)	AK0.102.220

TIP

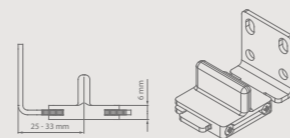

The AK9.335 guide is ideal in situations where you prefer not to fix the guiding channel to the floor.

Every fitting set comes with all the rollers or softclose mechanisms, suspension, guiding systems and stoppers you need.
* If the distance between the wall and door is at least 13 mm, Autoclose (p. 42) is an option for automatic door closure.

Technical drawings

Option 1 - Version A

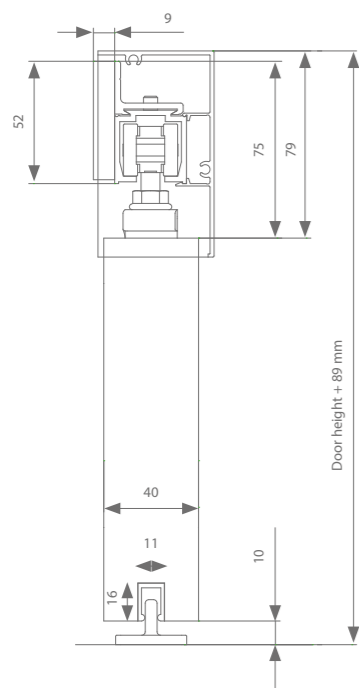

Option 2 - Version A

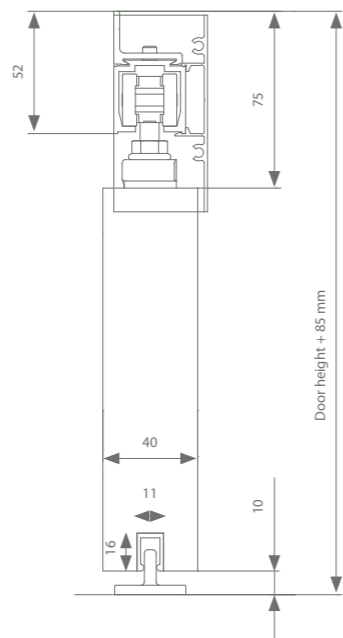

Option 1 - Version B

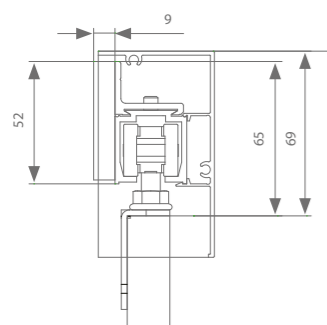

Option 2 - Version B

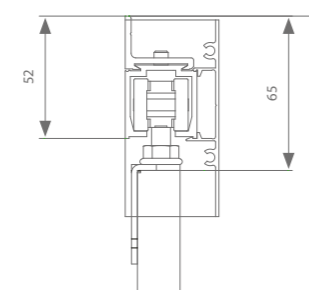

Height adjustment: + / - 3 mm

TIP



The AK9.335 guide is ideal in situations where you prefer not to fix the guiding channel to the floor.

Profiles

	Max. door width	Length	Reference
Running profile	1000 mm	2000 mm	AK0.208.200
	1500 mm	3000 mm	AK0.208.300
	2000 mm	4000 mm	AK0.208.400
	3000 mm	6000 mm	AK0.208.600
Wall bracket	Required every 500 - 600 mm		AK1.118.0
Cover profile (optie 1)	1000 mm	2000 mm	AK9.708.200
	1500 mm	3000 mm	AK9.708.300
	2000 mm	4000 mm	AK9.708.400
	3000 mm	6000 mm	AK9.708.600
+ end caps			AK9.708
Cover profile (optie 2)	1000 mm	2000 mm	AK0.938.200
	1500 mm	3000 mm	AK0.938.300
	2000 mm	4000 mm	AK0.938.400
	3000 mm	6000 mm	AK0.938.600
+ end caps			AK9.938
Guiding profile	1000 mm	1000 mm	510.608.100
	1250 mm	1250 mm	510.608.125
	1500 mm	1500 mm	510.608.150
	2000 mm	2000 mm	510.608.200
	3000 mm	3000 mm	510.608.300

Fittings selection

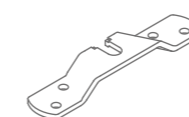

Transverse suspension (version A)	Reference
Without softclose	AK0.100
With 1 softclose (min. door width = 494 mm)	AK0.100.020*

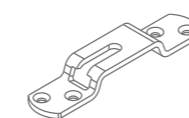

Lateral suspension (version A)	Reference
Without softclose	AK0.106

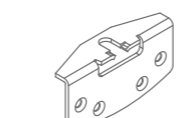

Thin panels with 18 - 38 mm door thickness (version B)	Reference
Without softclose	AK0.102
With 1 softclose (min. door width = 494 mm)	AK0.102.020
With 2 softcloses (min. door width = 724 mm)	AK0.102.220

Every fitting set comes with all the rollers or softclose mechanisms, suspension, guiding systems and stoppers you need.
* If the distance between the wall and door is at least 13 mm, Autoclose (p. 42) is an option for automatic door closure.

Technical drawing

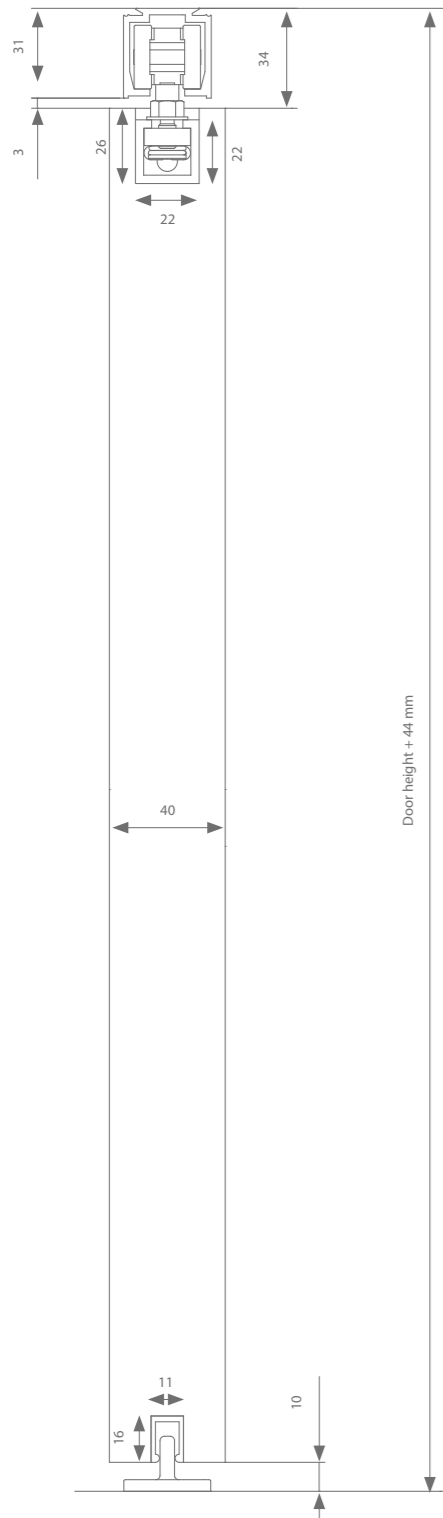

Height adjustment: + 0 / - 5 mm

Profiles

	Max. door width	Length	Reference
Running track	1000 mm	2000 mm	AK0.208.200
	1500 mm	3000 mm	AK0.208.300
	2000 mm	4000 mm	AK0.208.400
	3000 mm	6000 mm	AK0.208.600
Suspension profile		236 mm	(2x) 110.828
	1000 mm	1000 mm	110.828.100
	1250 mm	1250 mm	110.828.125
	1500 mm	1500 mm	110.828.150
	2000 mm	2000 mm	110.828.200
+ end caps			(2x) 110.829
	3000 mm	3000 mm	110.828.300
Guiding track	1000 mm	1000 mm	510.608.100
	1250 mm	1250 mm	510.608.125
	1500 mm	1500 mm	510.608.150
	2000 mm	2000 mm	510.608.200
	3000 mm	3000 mm	510.608.300

Fittings selection

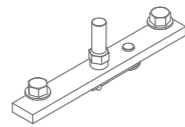

Compact suspension	Reference
Without softclose	AK0.308
With 1 softclose (min. door width = 502 mm)	AK0.308.020

Every fitting set comes with all the rollers or softclose mechanisms, suspension, guiding systems and stoppers you need.

TIP



The AK9.335 guide is ideal in situations where you prefer not to fix the guiding channel to the floor.

Technical drawing

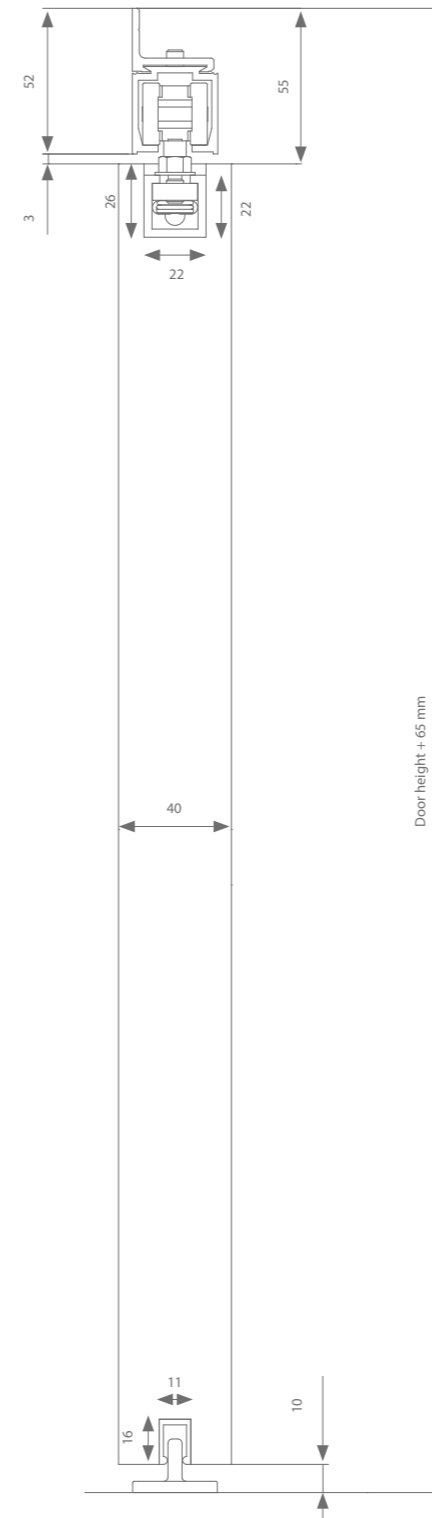

Height adjustment: + 0 / - 5 mm

Profiles

	Max. door width	Length	Reference
Running track	1000 mm	2000 mm	AK0.208.200
	1500 mm	3000 mm	AK0.208.300
	2000 mm	4000 mm	AK0.208.400
	3000 mm	6000 mm	AK0.208.600
Wall bracket	Required every 500 - 600 mm		AK1.118.0
Suspension profile		236 mm	(2x) 110.828
	1000 mm	1000 mm	110.828.100
	1250 mm	1250 mm	110.828.125
	1500 mm	1500 mm	110.828.150
	2000 mm	2000 mm	110.828.200
+ end caps			(2x) 110.829
	3000 mm	3000 mm	110.828.300
Guiding track	1000 mm	1000 mm	510.608.100
	1250 mm	1250 mm	510.608.125
	1500 mm	1500 mm	510.608.150
	2000 mm	2000 mm	510.608.200
	3000 mm	3000 mm	510.608.300

Fittings selection

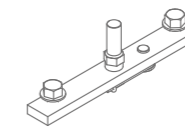

Compact suspension	Reference
Without softclose	AK0.308
With 1 softclose (min. door width = 502 mm)	AK0.308.020

Every fitting set comes with all the rollers or softclose mechanisms, suspension, guiding systems and stoppers you need.

TIP



The AK9.335 guide is ideal in situations where you prefer not to fix the guiding channel to the floor.



argenta
EXPERT
80 KG SUPERIOR

From 80 kg upwards, the expert range offers a superior range. These products guarantee a longer lifespan and quieter operation. The rollers are fitted with extra ball bearings of superior quality that guarantee extremely discreet operation. The wheels are made of hard UPVC, and together with the ball bearings, they ensure minimal rolling resistance. These unique properties guarantee extremely silent operation. The 80 kg superior stopper is fitted with an extra-strong stainless spring steel clamp that guarantees a longer lifespan. The bottom of the sliding door is also fitted with a stronger guiding system. For a more discreet finish, a compact version is available that limits the installation dimensions and facilitates a clearance of only 3 mm between the door and the track.

PROFILE LENGTH

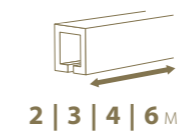

2 | 3 | 4 | 6 M

INSTALLATION



DOOR WEIGHT



anodised
aluminium

Technical drawings

Version A

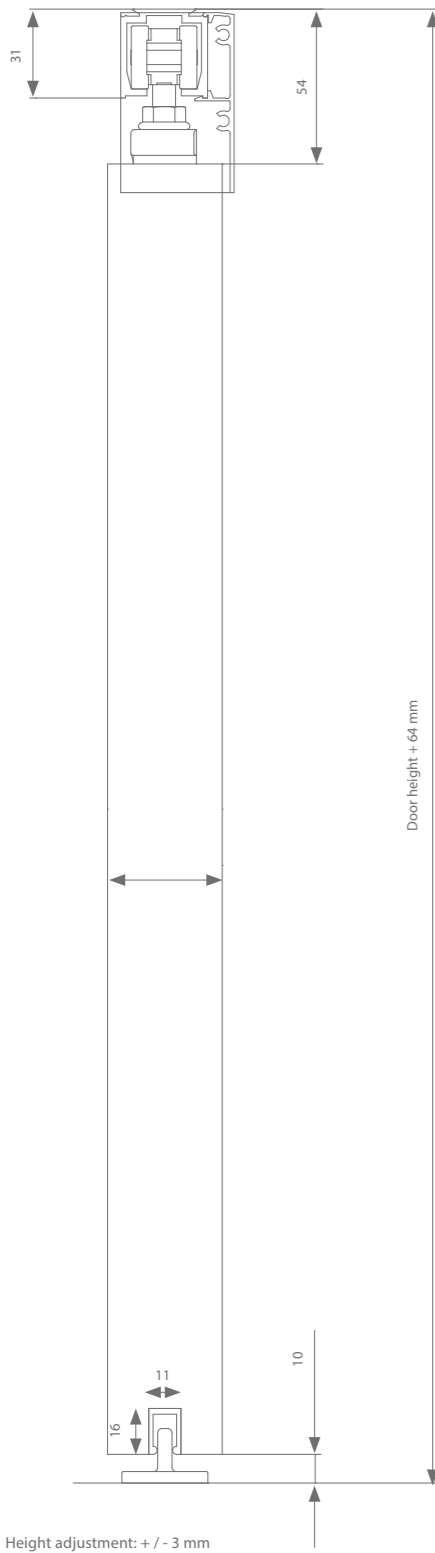

Version B

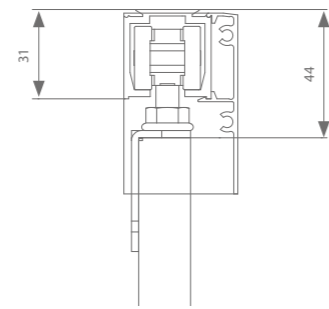

Profiles

	Max. door width	Length	Reference
Running track	1000 mm	2000 mm	AK0.208.200
	1500 mm	3000 mm	AK0.208.300
	2000 mm	4000 mm	AK0.208.400
	3000 mm	6000 mm	AK0.208.600
Cover profile	1000 mm	2000 mm	AK0.948.200
	1500 mm	3000 mm	AK0.948.300
	2000 mm	4000 mm	AK0.948.400
	3000 mm	6000 mm	AK0.948.600
+ end caps			AK9.948
Guiding track	1000 mm	1000 mm	510.608.100
	1250 mm	1250 mm	510.608.125
	1500 mm	1500 mm	510.608.150
	2000 mm	2000 mm	510.608.200
	3000 mm	3000 mm	510.608.300

Fittings selection

	Reference
Transverse suspension (version A)	
Without softclose	AK0.600
With 1 softclose (min. door width = 494 mm)	AK0.600.020
With 2 softcloses (min. door width = 724 mm)	AK0.600.220
Lateral suspension (version A)	
Without softclose	AK0.606
Thin panels with 18 - 38 mm door thickness (version B)	
Without softclose	AK0.602

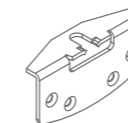
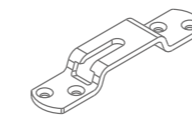
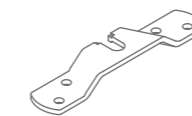

TIP

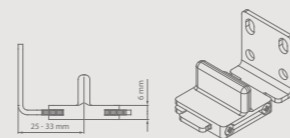

The AK9.335 guide is ideal in situations where you prefer not to fix the guiding channel to the floor.

Every fitting set comes with all the rollers or softclose mechanisms, suspension, guiding systems and stoppers you need.
* If the distance between the wall and door is at least 13 mm, Autoclose (p. 42) is an option for automatic door closure.

Technical drawings

Option 1 - Version A

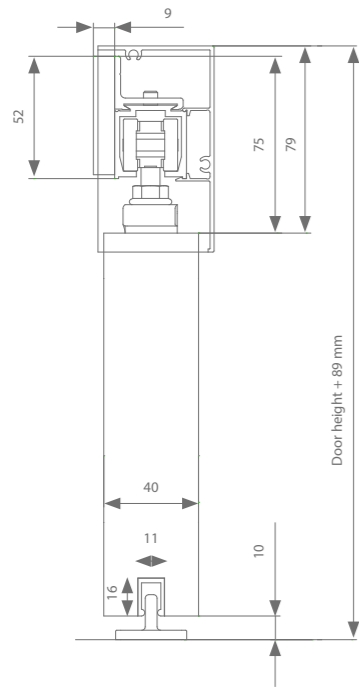

Option 2 - Version A

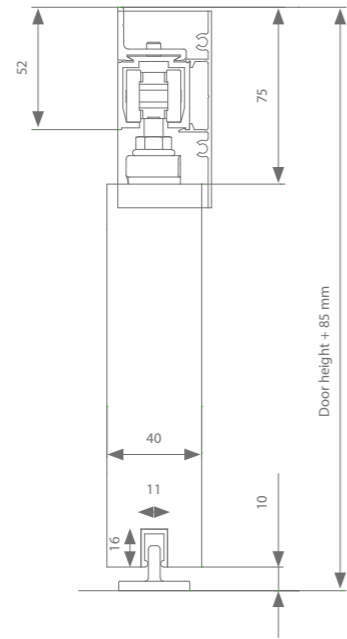

Option 1 - Version B

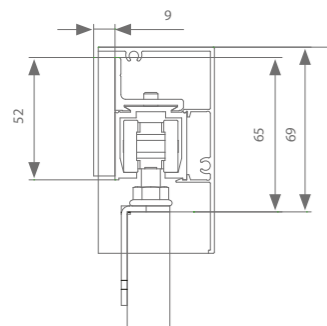

Option 2 - Version B

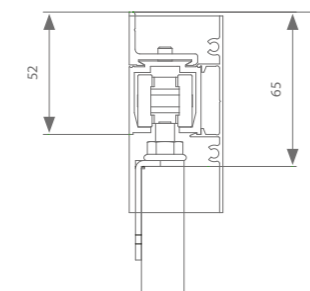

Height adjustment: +/- 3 mm

TIP



The AK9.335 guide is ideal in situations where you prefer not to fix the guiding channel to the floor.

Profiles

	Max. door width	Length	Reference
Running track	1000 mm	2000 mm	AK0.208.200
	1500 mm	3000 mm	AK0.208.300
	2000 mm	4000 mm	AK0.208.400
	3000 mm	6000 mm	AK0.208.600
Wall bracket	Required every 500 - 600 mm		AK1.118.0
Cover profile (optie 1)	1000 mm	2000 mm	AK9.708.200
	1500 mm	3000 mm	AK9.708.300
	2000 mm	4000 mm	AK9.708.400
	3000 mm	6000 mm	AK9.708.600
+ end caps			AK9.708
Cover profile (optie 2)	1000 mm	2000 mm	AK0.938.200
	1500 mm	3000 mm	AK0.938.300
	2000 mm	4000 mm	AK0.938.400
	3000 mm	6000 mm	AK0.938.600
+ end caps			AK9.938
Guiding track	1000 mm	1000 mm	510.608.100
	1250 mm	1250 mm	510.608.125
	1500 mm	1500 mm	510.608.150
	2000 mm	2000 mm	510.608.200
	3000 mm	3000 mm	510.608.300

Fittings selection

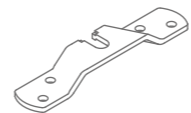
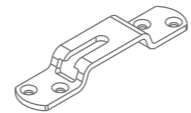
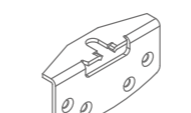
	Reference
Transverse suspension (version A)	
 Without softclose	AK0.600
With 1 softclose (min. door width = 494 mm)	AK0.600.020*
With 2 softcloses (min. door width = 724 mm)	AK0.600.220
Lateral suspension (version A)	
 Without softclose	AK0.606
Thin panels with 18 - 38 mm door thickness (version B)	
 Without softclose	AK0.602

Every fitting set comes with all the rollers or softclose mechanisms, suspension, guiding systems and stoppers you need.
* If the distance between the wall and door is at least 13 mm, Autoclose (p. 42) is an option for automatic door closure.

Technical drawing

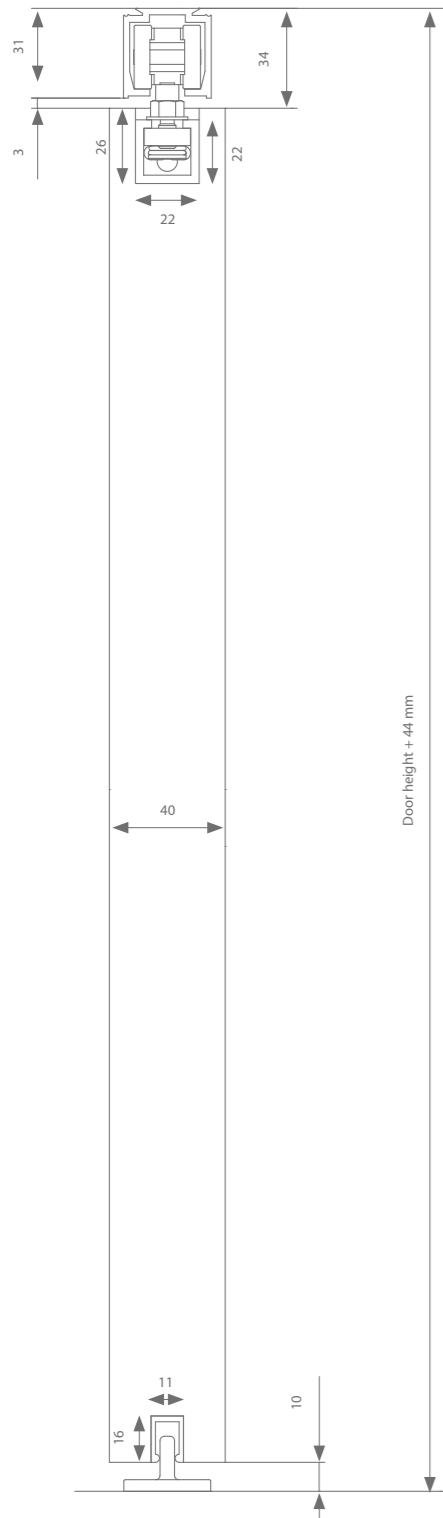

Height adjustment: + 0 / - 5 mm

Profiles

	Max. door width	Length	Reference
Running track	1000 mm	2000 mm	AK0.208.200
	1500 mm	3000 mm	AK0.208.300
	2000 mm	4000 mm	AK0.208.400
	3000 mm	6000 mm	AK0.208.600
Suspension profile		236 mm	(2x) 110.828
	1000 mm	1000 mm	110.828.100
	1250 mm	1250 mm	110.828.125
	1500 mm	1500 mm	110.828.150
	2000 mm	2000 mm	110.828.200
+ end caps			(2x) 110.829
	3000 mm	3000 mm	110.828.300
Guiding track	1000 mm	1000 mm	510.608.100
	1250 mm	1250 mm	510.608.125
	1500 mm	1500 mm	510.608.150
	2000 mm	2000 mm	510.608.200
	3000 mm	3000 mm	510.608.300

Fittings selection

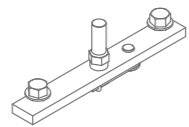

Compact suspension	Reference
Without softclose	AK0.808
With 1 softclose (min. door width = 502 mm)	AK0.808.020
With 2 softcloses (min. door width = 737 mm)	AK0.808.220
Unislide - Fittings to be combined with a hoist (max. 60 kg)	Reference
With 1 softclose	AK0.800.08

Every fitting set comes with all the rollers or softclose mechanisms, suspension, guiding systems and stoppers you need.

TIP

The AK9.335 guide is ideal in situations where you prefer not to fix the guiding channel to the floor.

Technical drawing

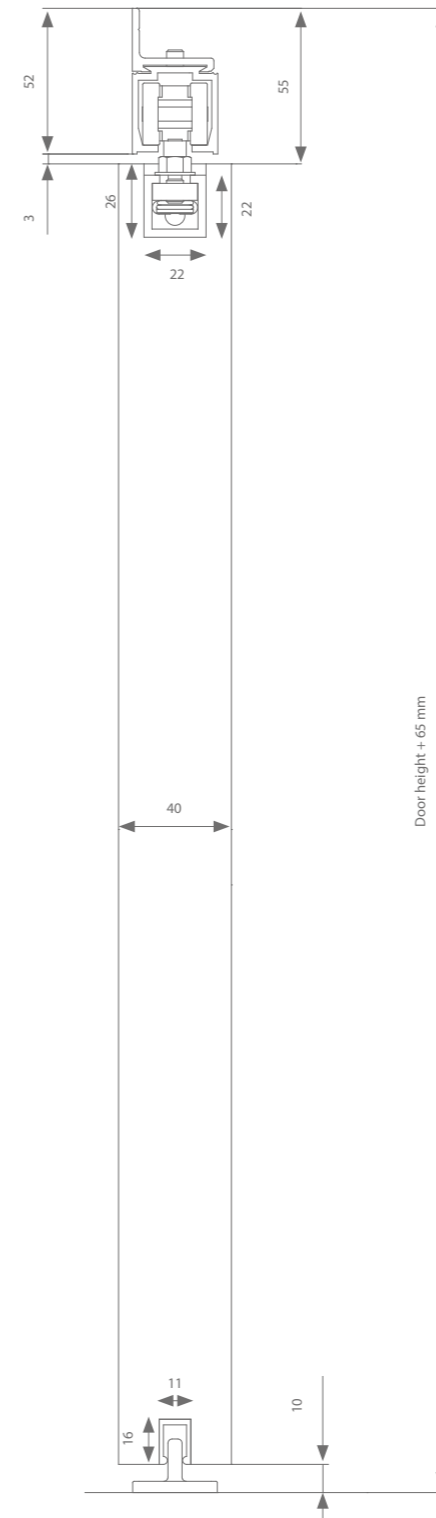

Height adjustment: + 0 / - 5 mm

Profiles

	Max. door width	Length	Reference
Running track	1000 mm	2000 mm	AK0.208.200
	1500 mm	3000 mm	AK0.208.300
	2000 mm	4000 mm	AK0.208.400
	3000 mm	6000 mm	AK0.208.600
Wall bracket	Required every 500 - 600 mm		AK1.118.0
Suspension profile		236 mm	(2x) 110.828
	1000 mm	1000 mm	110.828.100
	1250 mm	1250 mm	110.828.125
	1500 mm	1500 mm	110.828.150
	2000 mm	2000 mm	110.828.200
+ end caps			(2x) 110.829
	3000 mm	3000 mm	110.828.300
Guiding track	1000 mm	1000 mm	510.608.100
	1250 mm	1250 mm	510.608.125
	1500 mm	1500 mm	510.608.150
	2000 mm	2000 mm	510.608.200
	3000 mm	3000 mm	510.608.300

Fittings selection

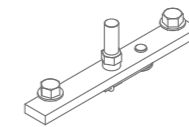

Compact suspension	Reference
Without softclose	AK0.808
With 1 softclose (min. door width = 502 mm)	AK0.808.020
With 2 softcloses (min. door width = 737 mm)	AK0.808.220
Unislide - Fittings to be combined with a hoist (max. 60 kg)	Reference
With 1 softclose	AK0.800.08

Every fitting set comes with all the rollers or softclose mechanisms, suspension, guiding systems and stoppers you need.

TIP

The AK9.335 guide is ideal in situations where you prefer not to fix the guiding channel to the floor.



argenta
EXPERT
120 KG SUPERIOR

The extra assets of the 80 kg superior range are repeated in the 120 kg series. These products guarantee a longer lifespan and quieter operation. Once again, the rollers are fitted with extra ball bearings of superior quality that guarantee extremely discreet operation. The strong bottom guiding system guarantees the door always remains at a perpendicular position. For a more discreet finish, a compact version is available that limits the installation dimensions and facilitates a clearance of only 3 mm between the door and the profile.

PROFILE LENGTH

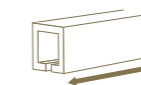

2 | 3 | 4 | 6 M

INSTALLATION



DOOR WEIGHT



MAX.
120
KG



anodised
aluminium

Technical drawing

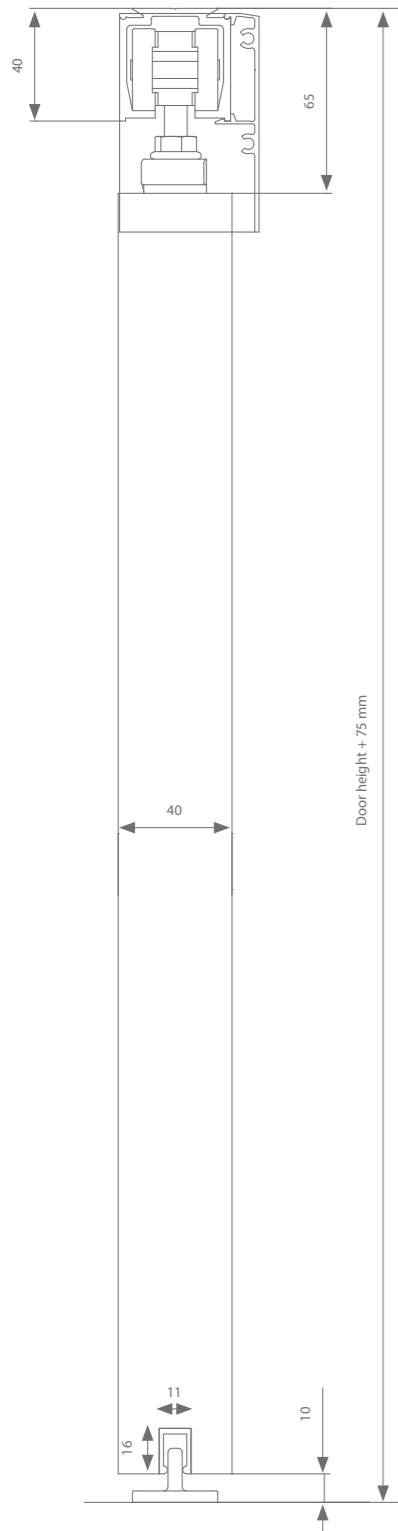

Height adjustment: +/- 5 mm

Profiles

	Max. door width	Length	Reference
Running track	1000 mm	2000 mm	AM0.208.200
	1500 mm	3000 mm	AM0.208.300
	2000 mm	4000 mm	AM0.208.400
	3000 mm	6000 mm	AM0.208.600
Cover profile	1000 mm	2000 mm	AM0.948.200
	1500 mm	3000 mm	AM0.948.300
	2000 mm	4000 mm	AM0.948.400
	3000 mm	6000 mm	AM0.948.600
+ end caps			AM9.948
Guiding track	1000 mm	1000 mm	510.608.100
	1250 mm	1250 mm	510.608.125
	1500 mm	1500 mm	510.608.150
	2000 mm	2000 mm	510.608.200
	3000 mm	3000 mm	510.608.300

Fittings selection

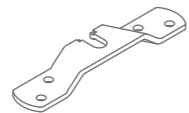

Transverse suspension	Reference
Without softclose	AM0.600
With 1 softclose (min. door width = 545 mm)	AM0.600.020
With 2 softcloses (min. door width = 774 mm)	AM0.600.220

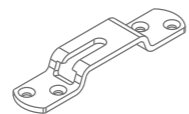

Lateral suspension	Reference
Without softclose	AM0.606

Every fitting set comes with all the rollers or softclose mechanisms, suspension, guiding systems and stoppers you need. * If the distance between the wall and door is at least 13 mm, Autoclose (p. 42) is an option for automatic door closure.

Technical drawing

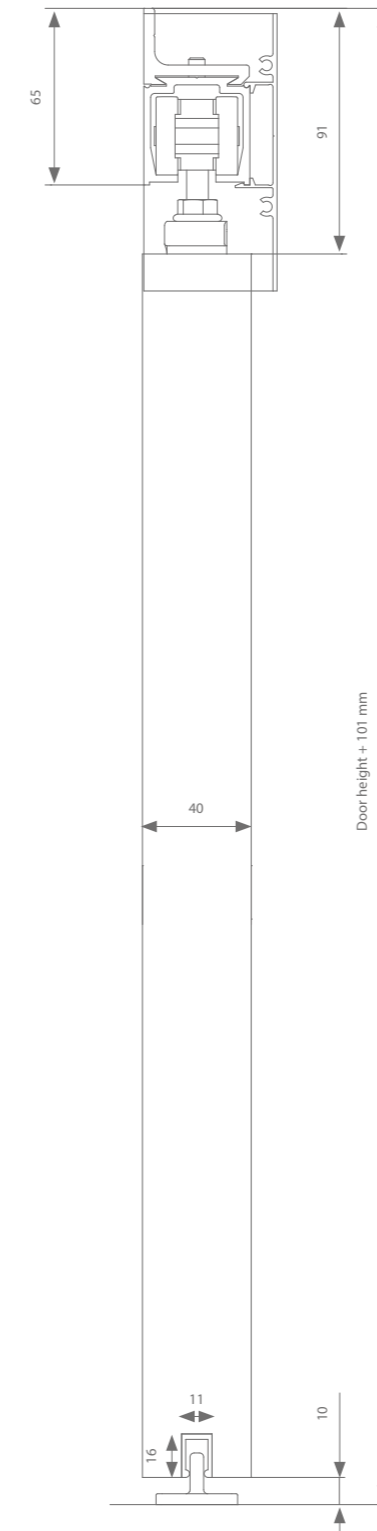

Height adjustment: +/- 5 mm

Profiles

	Max. door width	Length	Reference
Running track	1000 mm	2000 mm	AM0.208.200
	1500 mm	3000 mm	AM0.208.300
	2000 mm	4000 mm	AM0.208.400
	3000 mm	6000 mm	AM0.208.600
Wall bracket	Required every 500 - 600 mm		AM1.118.0
Cover profile	1000 mm	2000 mm	AM0.938.200
	1500 mm	3000 mm	AM0.938.300
	2000 mm	4000 mm	AM0.938.400
	3000 mm	6000 mm	AM0.938.600
+ end caps			AM9.938
Guiding track	1000 mm	1000 mm	510.608.100
	1250 mm	1250 mm	510.608.125
	1500 mm	1500 mm	510.608.150
	2000 mm	2000 mm	510.608.200
	3000 mm	3000 mm	510.608.300

Fittings selection

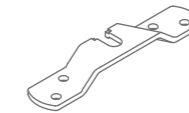

Transverse suspension	Reference
Without softclose	AM0.600
With 1 softclose (min. door width = 545 mm)	AM0.600.020*
With 2 softcloses (min. door width = 774 mm)	AM0.600.220

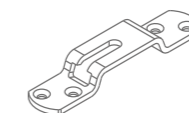

Lateral suspension	Reference
Without softclose	AM0.606

Every fitting set comes with all the rollers or softclose mechanisms, suspension, guiding systems and stoppers you need. * If the distance between the wall and door is at least 13 mm, Autoclose (p. 42) is an option for automatic door closure.

Technical drawing

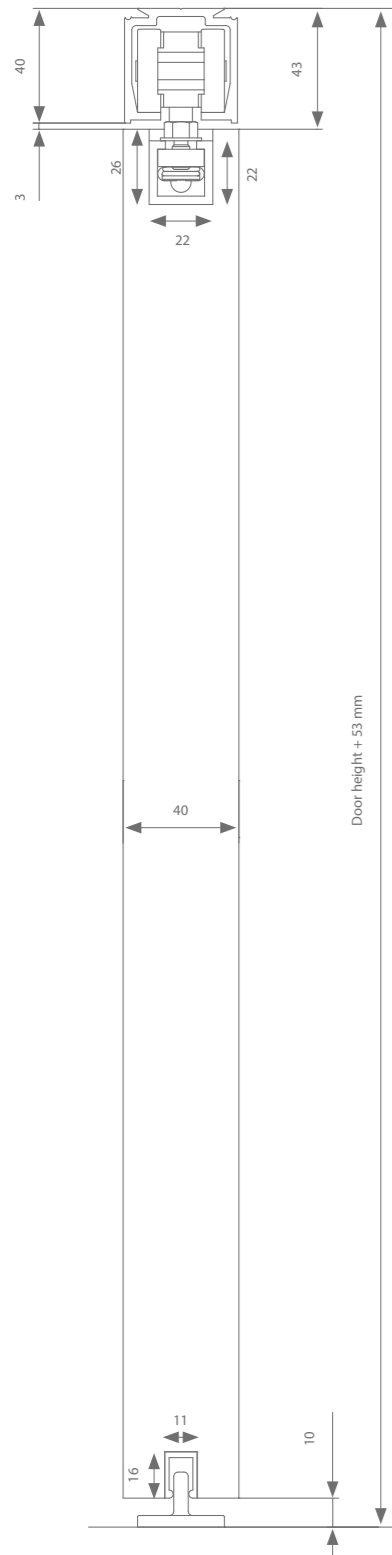

Height adjustment: + 0 / - 5 mm

Profiles

	Max. door width	Length	Reference
Running track	1000 mm	2000 mm	AM0.208.200
	1500 mm	3000 mm	AM0.208.300
	2000 mm	4000 mm	AM0.208.400
	3000 mm	6000 mm	AM0.208.600
Suspension profile		236 mm	(2x) 110.828
	1000 mm	1000 mm	110.828.100
	1250 mm	1250 mm	110.828.125
	1500 mm	1500 mm	110.828.150
	2000 mm	2000 mm	110.828.200
+ end caps			(2x) 110.829
Guiding track	1000 mm	1000 mm	510.608.100
	1250 mm	1250 mm	510.608.125
	1500 mm	1500 mm	510.608.150
	2000 mm	2000 mm	510.608.200
	3000 mm	3000 mm	510.608.300

Fittings selection

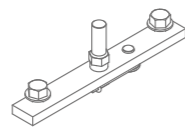

Compact suspension	Reference
Without softclose	AM0.808
With 1 softclose (min. door width = 552 mm)	AM0.808.020
With 2 softcloses (min. door width = 787 mm)	AM0.808.220

Every fitting set comes with all the rollers or softclose mechanisms, suspension, guiding systems and stoppers you need.

Technical drawing

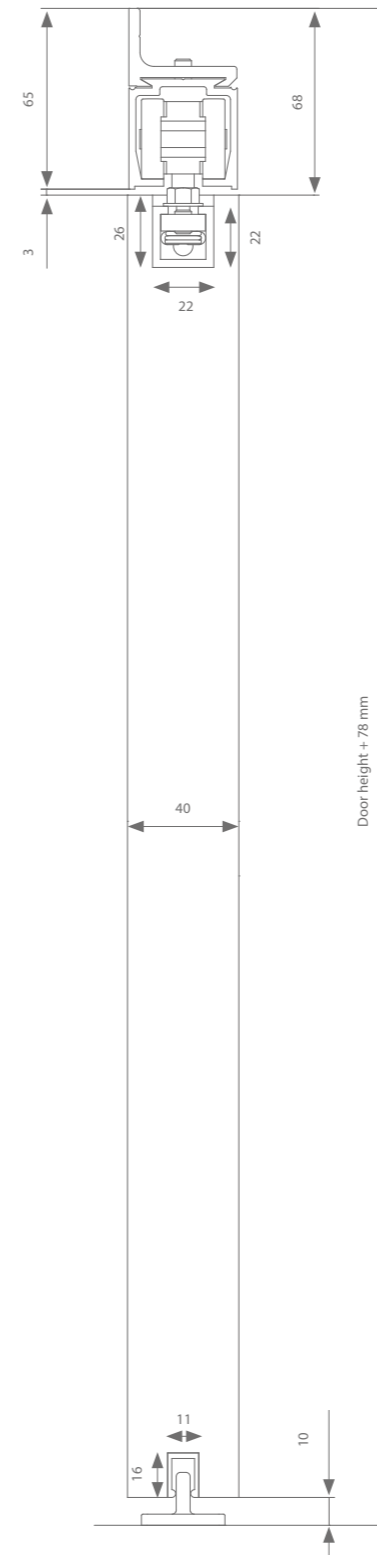

Height adjustment: + 0 / - 5 mm

Profiles

	Max. door width	Length	Reference
Running track	1000 mm	2000 mm	AM0.208.200
	1500 mm	3000 mm	AM0.208.300
	2000 mm	4000 mm	AM0.208.400
	3000 mm	6000 mm	AM0.208.600
Wall bracket	Required every 500 - 600 mm		AM1.118.0
Suspension profile		236 mm	(2x) 110.828
	1000 mm	1000 mm	110.828.100
	1250 mm	1250 mm	110.828.125
	1500 mm	1500 mm	110.828.150
	2000 mm	2000 mm	110.828.200
+ end caps			(2x) 110.829
Guiding track	1000 mm	1000 mm	510.608.100
	1250 mm	1250 mm	510.608.125
	1500 mm	1500 mm	510.608.150
	2000 mm	2000 mm	510.608.200
	3000 mm	3000 mm	510.608.300

Fittings selection

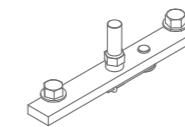

Compact suspension	Reference
Without softclose	AM0.808
With 1 softclose (min. door width = 552 mm)	AM0.808.020
With 2 softcloses (min. door width = 737 mm)	AM0.808.220

Every fitting set comes with all the rollers or softclose mechanisms, suspension, guiding systems and stoppers you need.



argenta
EXPERT
200 KG

Heavy sliding doors of up to 200 kg are hung on a strong steel roller fitted with ball-bearing UPVC wheels that guarantee smooth rolling movement in the aluminium profile. Also for these door weights, quality and discreet operation go hand in hand. The strong bottom guiding system guarantees a correct setup.

PROFILE LENGTH

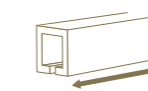

2 | 3 | 4 | 6 M

INSTALLATION



DOOR WEIGHT

MAX.
200
KG



anodised
aluminium

Technical drawing

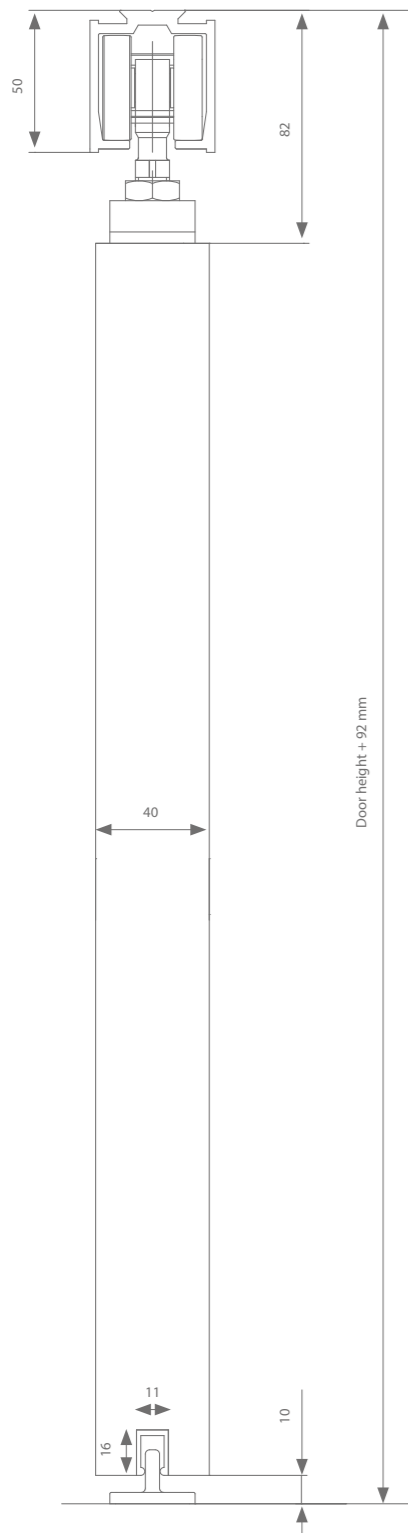

Height adjustment: +/- 3 mm

Profiles

	Max. door width	Length	Reference
Running track	1000 mm	2000 mm	AP0.208.200
	1500 mm	3000 mm	AP0.208.300
	2000 mm	4000 mm	AP0.208.400
	3000 mm	6000 mm	AP0.208.600
Guiding track	1000 mm	1000 mm	510.608.100
	1250 mm	1250 mm	510.608.125
	1500 mm	1500 mm	510.608.150
	2000 mm	2000 mm	510.608.200
	3000 mm	3000 mm	510.608.300

Fittings selection

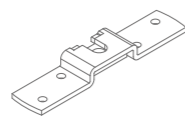

Transverse suspension	Reference
Without softclose	AP0.600

Every fitting set comes with all the rollers, suspension, guiding systems and stoppers you need.

Stronger guiding system option

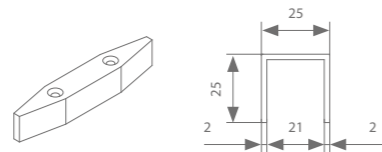

	Max. door width	Length	Reference
Guiding track	1000 mm	1000 mm	AK0.618.100
	2000 mm	2000 mm	AK0.618.200
	3000 mm	3000 mm	AK0.618.300
	4000 mm	4000 mm	AK0.618.400
	6000 mm	6000 mm	AK0.618.600
Guide			129.315

Technical drawing

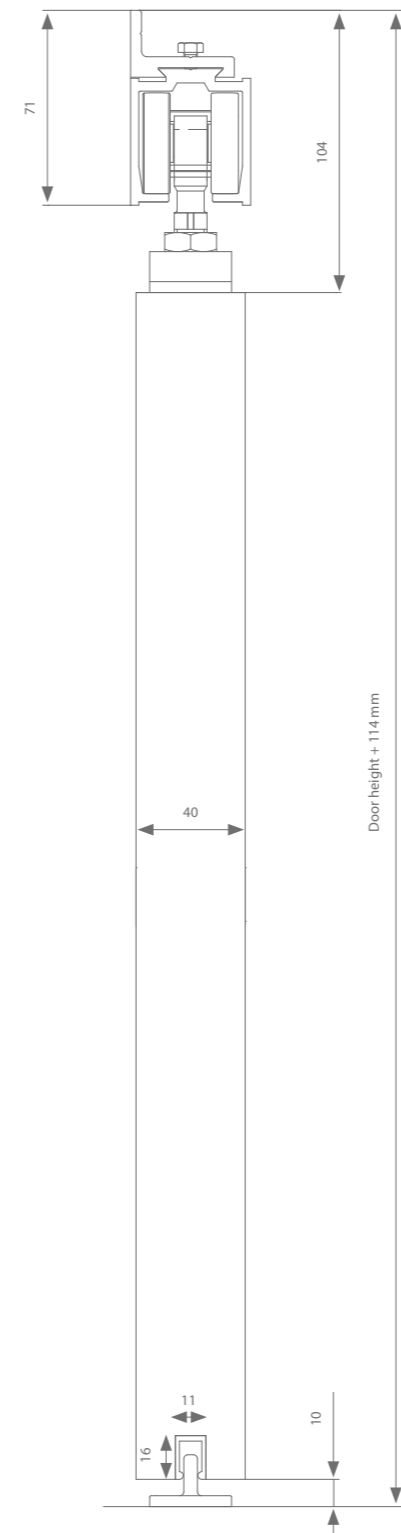

Height adjustment: +/- 3 mm

Profiles

	Max. door width	Length	Reference
Running track	1000 mm	2000 mm	AP0.208.200
	1500 mm	3000 mm	AP0.208.300
	2000 mm	4000 mm	AP0.208.400
	3000 mm	6000 mm	AP0.208.600
Wall bracket	Elke 500 - 600mm nodig		AP1.118.0
Guiding track	1000 mm	1000 mm	510.608.100
	1250 mm	1250 mm	510.608.125
	1500 mm	1500 mm	510.608.150
	2000 mm	2000 mm	510.608.200
	3000 mm	3000 mm	510.608.300

Fittings selection

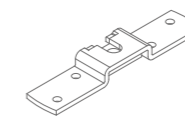

Transverse suspension	Reference
Without softclose	AP0.600

Every fitting set comes with all the rollers or softclose mechanisms, suspension, guiding systems and stoppers you need.

Stronger guiding system option

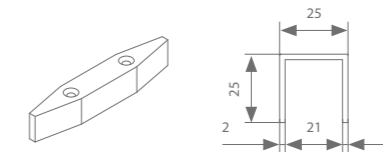

	Max. door width	Length	Reference
Guiding track	1000 mm	1000 mm	AK0.618.100
	2000 mm	2000 mm	AK0.618.200
	3000 mm	3000 mm	AK0.618.300
	4000 mm	4000 mm	AK0.618.400
	6000 mm	6000 mm	AK0.618.600
Guide			129.315

argenta

EXPERT 40 - 120 KG COMPLETE SETS

Technical drawings

40 - 80 kg

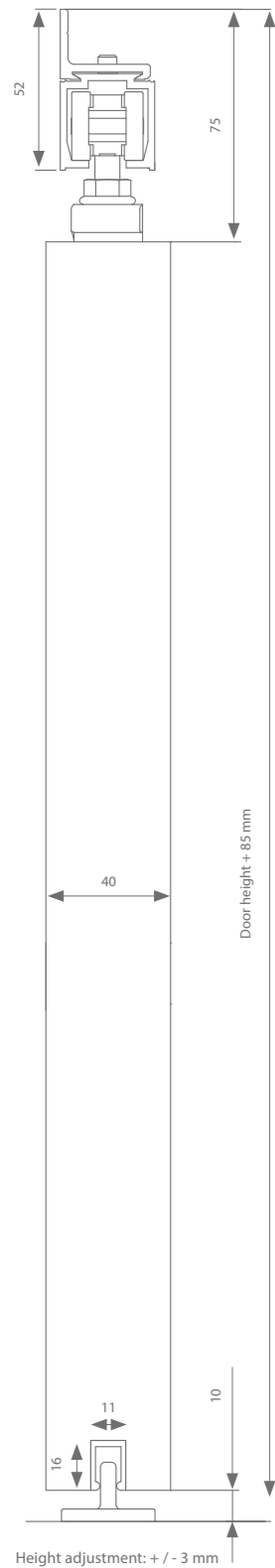

120 kg

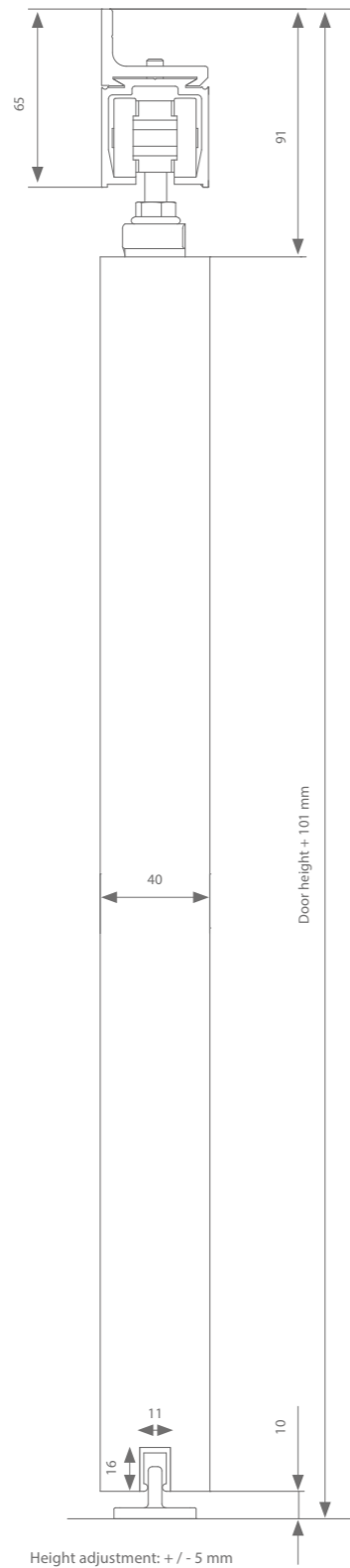

A total set contains the following items:

- Running track 2000 or 3000 mm
- Suitable number of wall brackets
- Accessories including:
 - 2 transverse supporting plates
 - 2 rollers & 2 stoppers
OR 1 roller and 1 softclose & 1 stopper
OR 2 softcloses
 - Guiding channel
 - Guiding track
 - Associated screws

Max. 40 kg	Max. door width	Length	Reference
Expert 40 / 200	1000 mm	2000 mm	AG0.108
Expert 40 / 300	1500 mm	3000 mm	AG0.178
Expert 40 / 200 With softclose	1000 mm	2000 mm	AG0.108.020
Expert 40 / 300 With softclose	1500 mm	3000 mm	AG0.178.020
Softclose expansion*			AG4.395.020

Max. 80 kg	Max. door width	Length	Reference
Expert 80 / 200	1000 mm	2000 mm	AK0.108
Expert 80 / 300	1500 mm	3000 mm	AK0.178
Expert 80 / 200 With softclose	1000 mm	2000 mm	AK0.108.020
Expert 80 / 300 With softclose	1500 mm	3000 mm	AK0.178.020
Softclose expansion*			AK4.395.020

Max. 80 kg Superior	Max. door width	Length	Reference
Expert 80 Superior / 200	1000 mm	2000 mm	AK0.608
Expert 80 Superior / 300	1500 mm	3000 mm	AK0.678
Expert 80 Superior / 200 With softclose	1000 mm	2000 mm	AK0.608.020
Expert 80 Superior / 300 With softclose	1500 mm	3000 mm	AK0.678.020
Expert 80 superior / 200 With double softclose	1000 mm	2000 mm	AK0.608.220
Expert 80 superior / 300 With double softclose	1500 mm	3000 mm	AK0.678.220

Max. 120 kg Superior*	Max. door width	Length	Reference
Expert 120 Superior / 300	1500 mm	3000 mm	AM0.678
Expert 120 Superior / 300 With softclose	1500 mm	3000 mm	AM0.678.020
Softclose expansion**			AM4.395.020

* 40 - 80 kg: 1 softclose = minimum door width 494 mm, 2 softcloses = minimum door width 724 mm

** 120 kg: 1 softclose = minimum door width 545 mm, 2 softcloses = minimum door width 774 mm



argenta EXPERT AUTOCLOSE

What are the benefits ?

- Closes softly through self-braking weights and softclose mechanism
- The system is always concealed behind the door

Features

- Suitable for ceiling or wall mounting
- The minimum required space between the door and wall is 13 mm
- Maximum door width = door height - 850 mm

Info

The **AK0.192** Autoclose set can be combined with the following fitting sets:

40 kg	AG0.100.020
80 kg	AK0.100.020
80 kg superior	AK0.600.020
120 kg	AM0.600.020

Technical drawings

40 - 80 kg

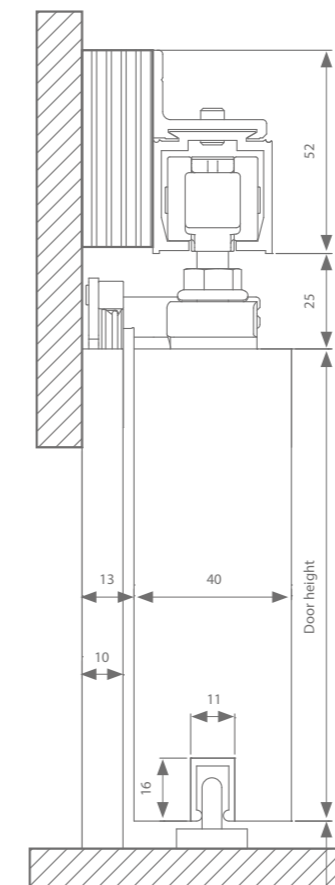

120 kg

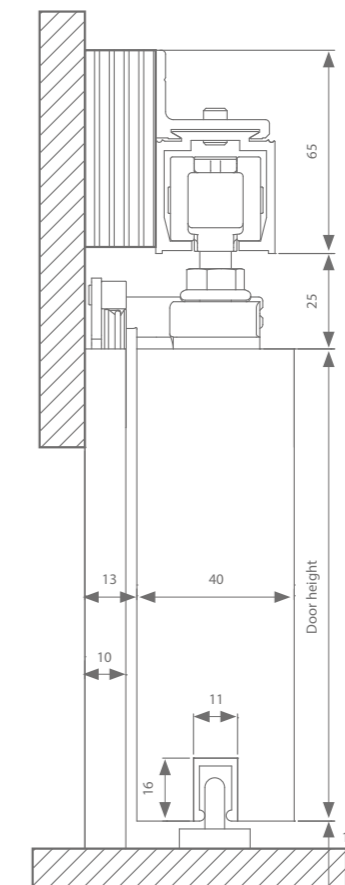



argenta **UNISLIDE**

The unislide fitting allows the crossing of a sliding door with a hoisting system for less mobile persons and is therefore perfectly applicable in the healthcare sector. The door is suspended by a soft close in the middle and a clearance-free roller at the back. The clearance-free roller prevents the door from tilting, the soft close always allows the door to close gently.

Technical drawing

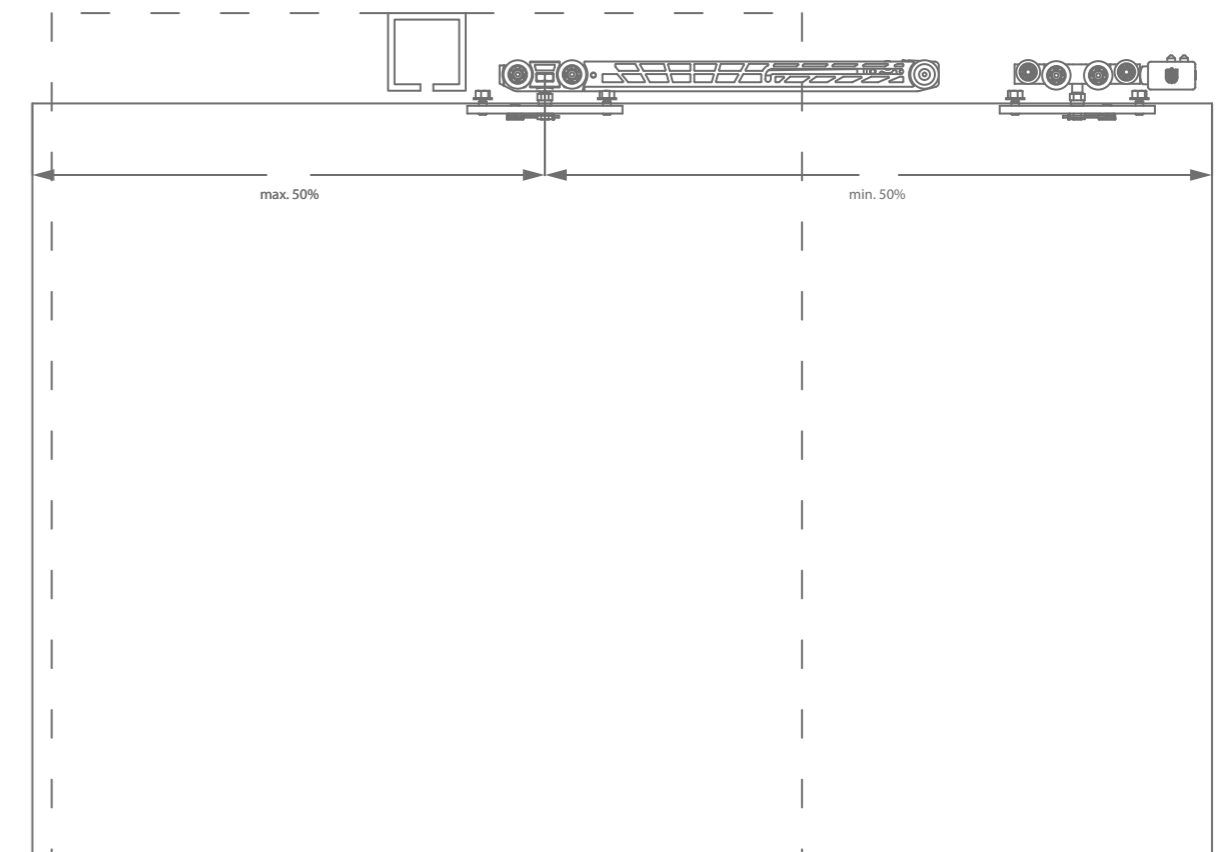



02

CUBE TIMBER

The cube hardware has a much sleeker appearance since no wall brackets are required. The running track comes pre drilled on the side, which means it can be screwed to the wall in no time at all. The system is finished discreetly with a cover profile and the associated end caps.

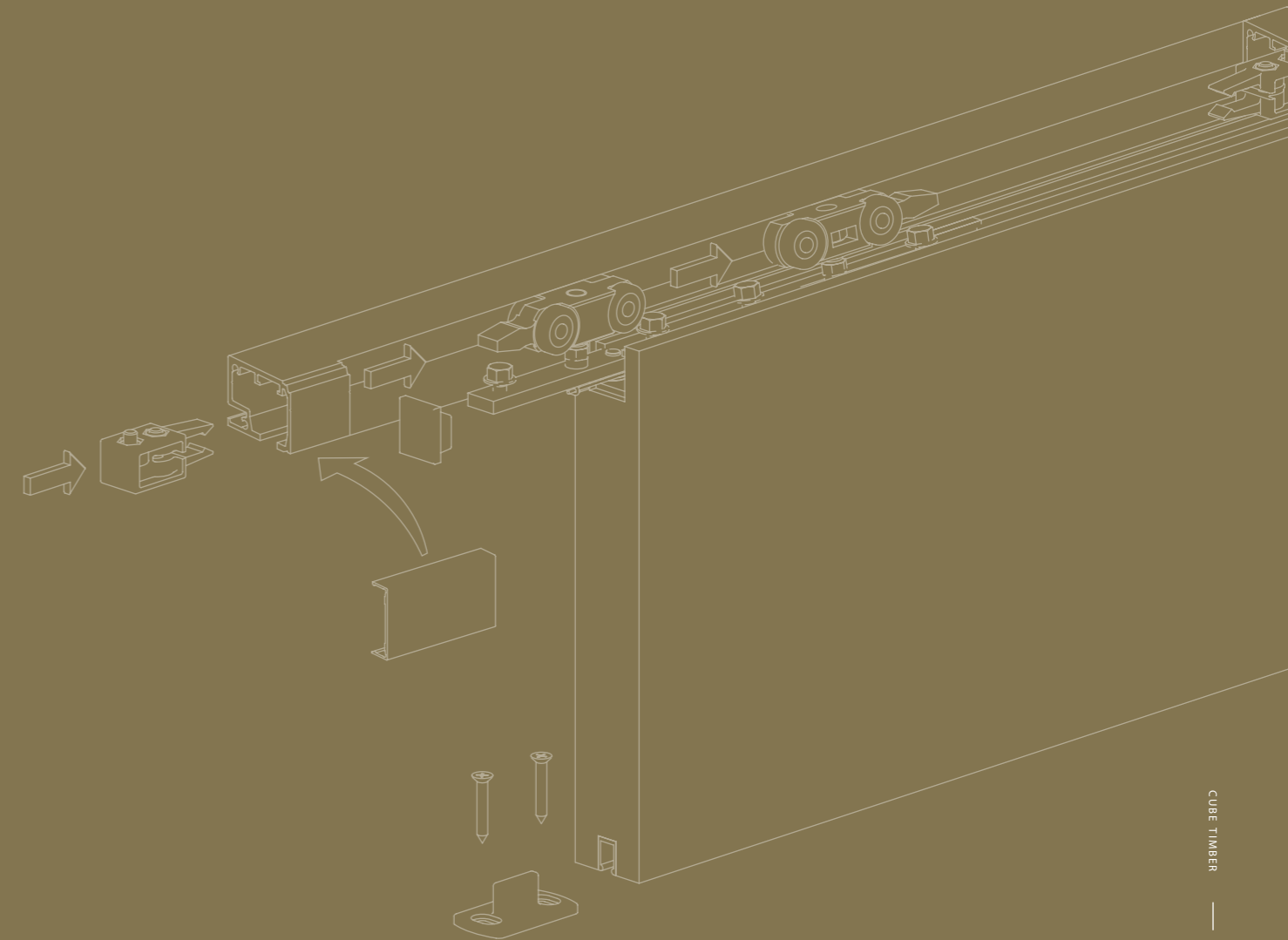



argenta
CUBE
 40 - 80 KG

Cube 40 kg is only available in grey, while cube 80 kg is available in either grey or black anodised aluminium and is always combined with compact superior fittings for a limited clearance of only 3 mm between the door and profile.

PROFILE LENGTH

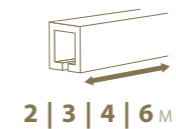

INSTALLATION



DOOR THICKNESS

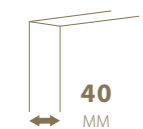

DOOR WEIGHT



grey anodised
aluminium (80 kg)

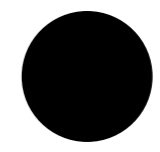

black anodised
aluminium (40 & 80 kg)

argenta cube 40 kg
compact wall mounting

assemble your set 

Technical drawing

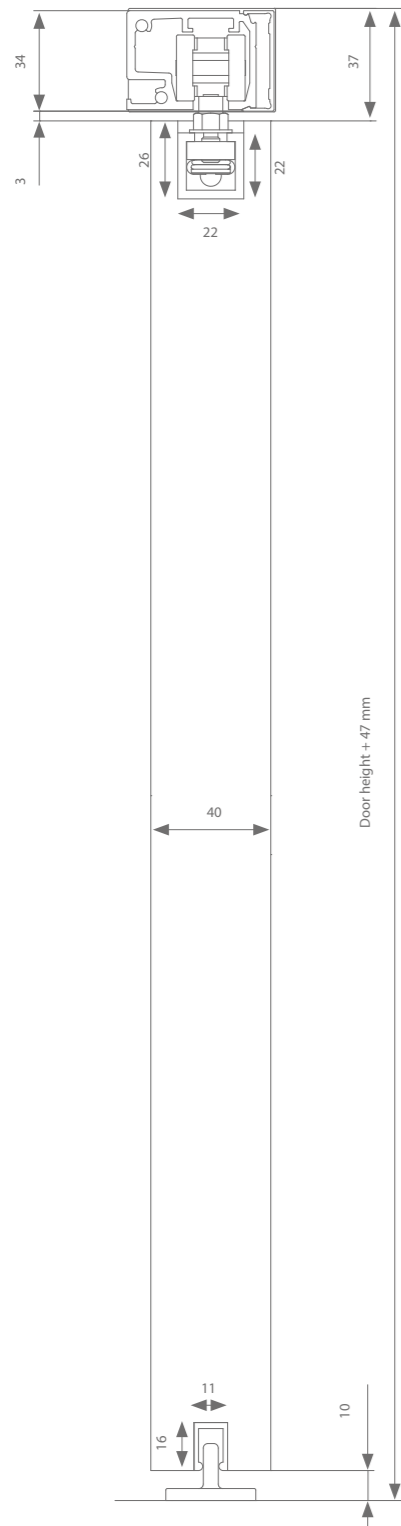

Height adjustment: + 0 / - 5 mm

Profiles

	Max. door width	Length	Reference
Running track	1000 mm	2000 mm	AG1.118.200
	1500 mm	3000 mm	AG1.118.300
	2000 mm	4000 mm	AG1.118.400
	3000 mm	6000 mm	AG1.118.600
Cover profile	1000 mm	2000 mm	AK1.918.200
	1500 mm	3000 mm	AK1.918.300
	2000 mm	4000 mm	AK1.918.400
	3000 mm	6000 mm	AK1.918.600
+ end caps			AK9.118
Suspension profile		236 mm	(2x) 110.828
	1000 mm	1000 mm	110.828.100
	1250 mm	1250 mm	110.828.125
	1500 mm	1500 mm	110.828.150
	2000 mm	2000 mm	110.828.200
+ end caps			(2x) 110.829
	3000 mm	3000 mm	110.828.300
Guiding track	1000 mm	1000 mm	510.608.100
	1250 mm	1250 mm	510.608.125
	1500 mm	1500 mm	510.608.150
	2000 mm	2000 mm	510.608.200
	3000 mm	3000 mm	510.608.300

Fittings selection

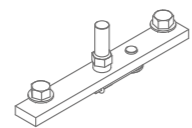

Compact suspension	Reference
Without softclose	AG0.308
With 1 softclose (min. door width = 502 mm)	AG0.308.020
With 2 softcloses (min. door width = 737 mm)	AG0.308.220

Every fitting set comes with all the rollers or softclose mechanisms, suspension, guiding systems and stoppers you need.



argenta cube 80 kg
compact wall mounting

assemble your set 

Technical drawing

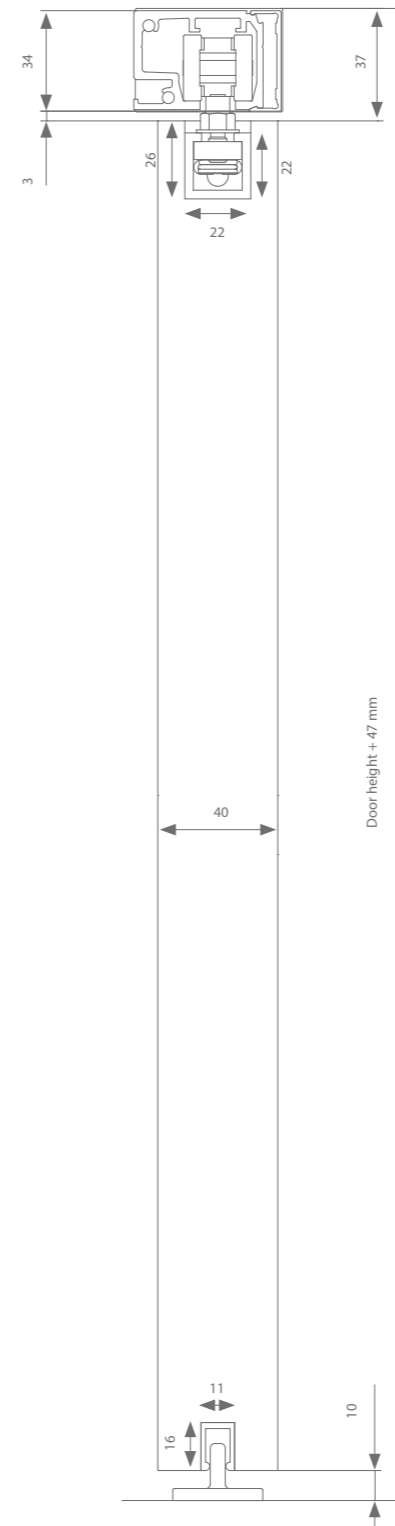

Height adjustment: + 0 / - 5 mm

Profiles

	Max. door width	Length	Reference
Running track grey anodised aluminium	1000 mm	2000 mm	AK1.118.200
	1500 mm	3000 mm	AK1.118.300
	2000 mm	4000 mm	AK1.118.400
	3000 mm	6000 mm	AK1.118.600
Cover profile grey anodised aluminium	1000 mm	2000 mm	AK1.918.200
	1500 mm	3000 mm	AK1.918.300
	2000 mm	4000 mm	AK1.918.400
	3000 mm	6000 mm	AK1.918.600
+ end caps			AK9.118
Running track black anodised aluminium		236 mm	(2x) 110.828
	1000 mm	1000 mm	110.828.100
	1250 mm	1250 mm	110.828.125
	1500 mm	1500 mm	110.828.150
	2000 mm	2000 mm	110.828.200
+ end caps			(2x) 110.829
	3000 mm	3000 mm	110.828.300
Cover profile black anodised aluminium	1000 mm	2000 mm	AK1.912.200
	1500 mm	3000 mm	AK1.912.300
	2000 mm	4000 mm	AK1.912.400
	3000 mm	6000 mm	AK1.912.600
	+ end caps		
Guiding track	1000 mm	1000 mm	510.608.100
	1250 mm	1250 mm	510.608.125
	1500 mm	1500 mm	510.608.150
	2000 mm	2000 mm	510.608.200
	3000 mm	3000 mm	510.608.300

Fittings selection

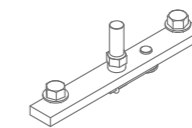

Compact suspension	Reference
Without softclose	AK0.808
With 1 softclose (min. door width = 502 mm)	AK0.808.020
With 2 softcloses (min. door width = 737 mm)	AK0.808.220



Every fitting set comes with all the rollers or softclose mechanisms, suspension, guiding systems and stoppers you need.



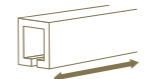

argenta
CUBE
 STEEL DOORS UP TO 80 KG

By omitting the wall brackets, the cube system has a much sleeker appearance than the standard expert setup. The running track can be screwed to the wall in no time thanks to the holes provided on the side. The use of a suspension plate allows it to be combined with steel doors. The cover profile with end caps completes this wall mount solution.

PROFILE LENGTH	INSTALLATION	DOOR THICKNESS	DOOR WEIGHT
 2 3 4 6 M		 40 MM	<div style="border: 1px solid black; padding: 5px; text-align: center;"> MAX. 80 KG </div>

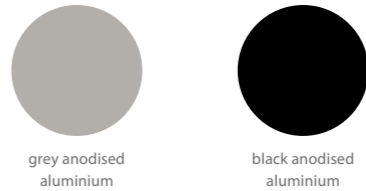

Technical drawing

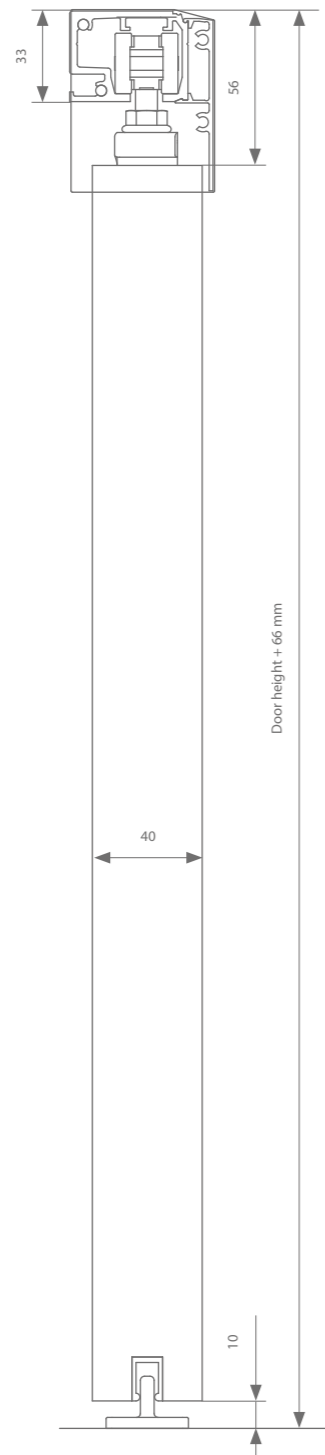

Height adjustment: +/- 3 mm

Profiles

	Max. door width	Length	Reference
Running track (grey anodised aluminium)	1000 mm	2000 mm	AK1.118.200
	1500 mm	3000 mm	AK1.118.300
	2000 mm	4000 mm	AK1.118.400
	3000 mm	6000 mm	AK1.118.600
Running track (black anodised aluminium)	1000 mm	2000 mm	AK1.112.200
	1500 mm	3000 mm	AK1.112.300
	2000 mm	4000 mm	AK1.112.400
	3000 mm	6000 mm	AK1.112.600
Cover profile (grey anodised aluminium)	1000 mm	2000 mm	AK0.948.200
	1500 mm	3000 mm	AK0.948.300
	2000 mm	4000 mm	AK0.948.400
	3000 mm	6000 mm	AK0.948.600
+ end caps			AK9.118.000.48
Cover profile (RAL 9005)	1000 mm	2000 mm	AK0.942.200
	1500 mm	3000 mm	AK0.942.300
	2000 mm	4000 mm	AK0.942.400
	3000 mm	6000 mm	AK0.942.600
+ end caps			AK9.112.000.48
Guiding track	1000 mm	1000 mm	510.608.100
	1250 mm	1250 mm	510.608.125
	1500 mm	1500 mm	510.608.150
	2000 mm	2000 mm	510.608.200
	3000 mm	3000 mm	510.608.300

Fittings selection

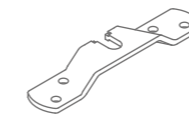

Transverse suspension	Reference
Without softclose	AK0.600
With 1 softclose (min. door width = 494 mm)	AK0.600.020*
With 2 softcloses (min. door width = 724 mm)	AK0.600.220

Every fitting set comes with all the rollers or softclose mechanisms, suspension, guiding systems and stoppers you need.

argenta

CUBE 80 KG COMPACT TOTAL SETS

A total set contains the following items:

- Anodised running profile 2000 or 3000 mm
- Anodised cover profile 2000 or 3000 mm
- Set of anodised end caps
- 2 236 mm installation profiles
- 2 rubber end caps
- Accessories including:
 - 2 sup. compact rollers & 2 sup. stoppers
OR 1 sup. compact roller with 1 compact softclose & 1 sup. stopper
OR 2 sup. compact softcloses
 - Guiding channel
 - Guiding track
 - Associated screws

Cube max. 80 kg superior - grey anodised	Max. door width	Length	Reference
Expert Cube 80 Superior / 200	1000 mm	2000 mm	AK0.830.200
Expert Cube 80 Superior / 300	1500 mm	3000 mm	AK0.830.300
Expert Cube 80 Superior 1 softclose / 200	1000 mm	2000 mm	AK0.830.200.20
Expert Cube 80 Superior 1 softclose / 300	1500 mm	3000 mm	AK0.830.300.20
Expert Cube 80 Superior 2 softcloses / 200	1000 mm	2000 mm	AK0.830.200.22
Expert Cube 80 Superior 2 softcloses / 300	1500 mm	3000 mm	AK0.830.300.22

Cube max. 80 kg superior - black anodised	Max. door width	Length	Reference
Expert Cube 80 Superior / 200	1000 mm	2000 mm	AK0.832.200
Expert Cube 80 Superior / 300	1500 mm	3000 mm	AK0.832.300
Expert Cube 80 Superior 1 softclose / 200	1000 mm	2000 mm	AK0.832.200.20
Expert Cube 80 Superior 1 softclose / 300	1500 mm	3000 mm	AK0.832.300.20
Expert Cube 80 Superior 2 softcloses / 200	1000 mm	2000 mm	AK0.832.200.22
Expert Cube 80 Superior 2 softcloses / 300	1500 mm	3000 mm	AK0.832.300.22

* 1 softclose = minimum door width 512 mm, 2 softcloses = door width 757 mm

Technical drawing

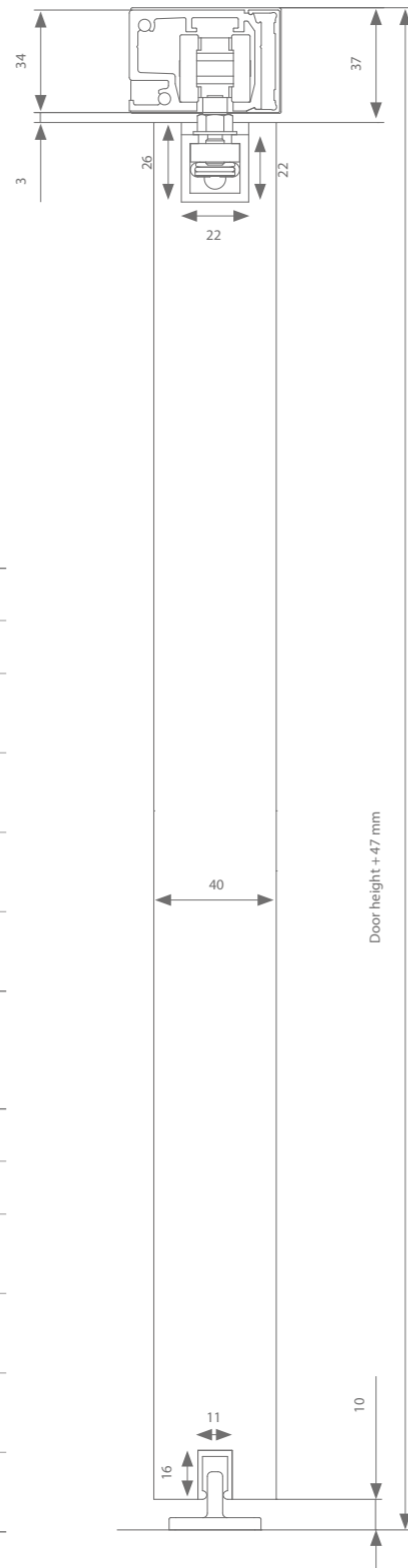

Height adjustment: + 0 / - 5 mm

03

LATENT TIMBER

When using latent, ceiling high door scan be fitted in an extreme minimalist way. The running track is totally concealed into the ceiling and fitted with an invisible access hatch. This means all rollers, stoppers and softcloses can be (dis)assembled without causing damage to the ceiling.

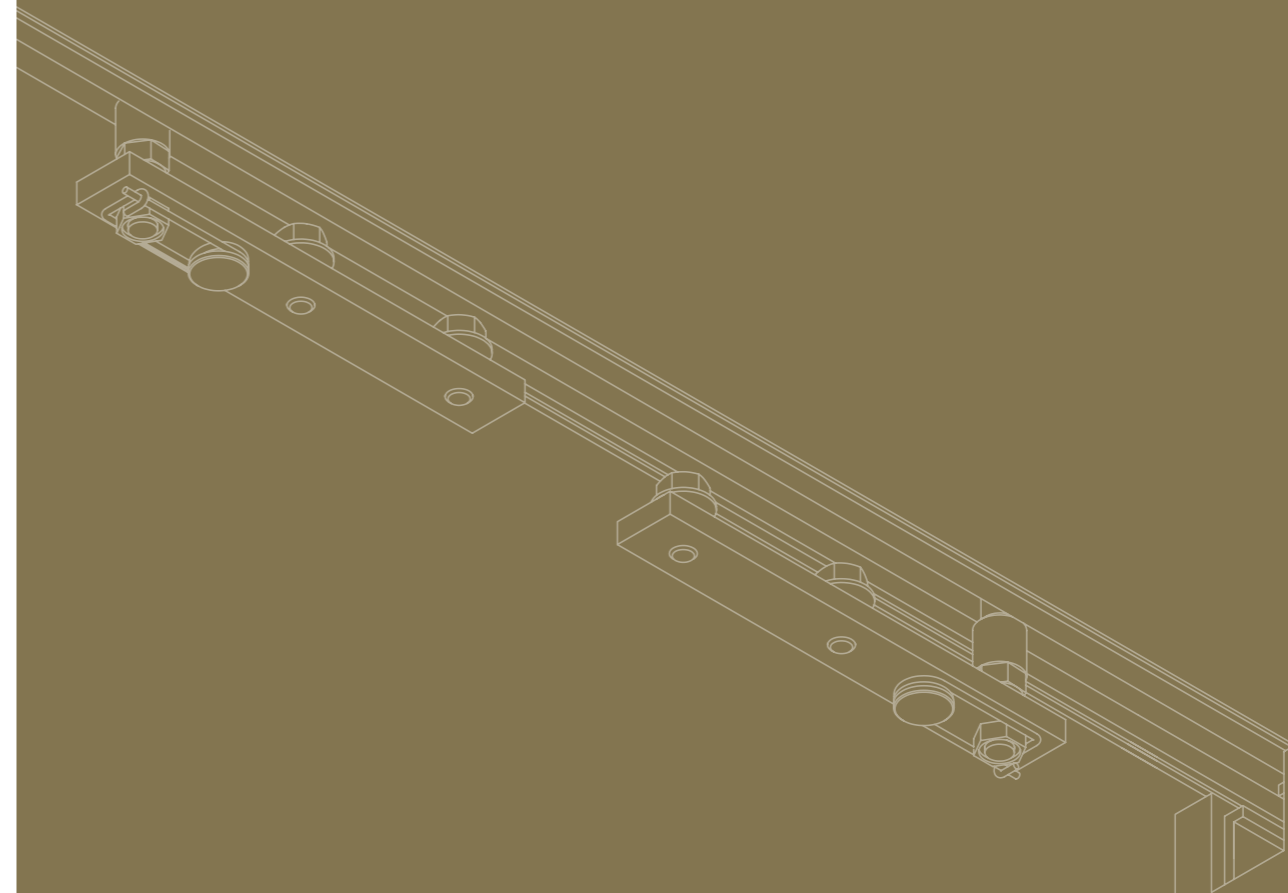

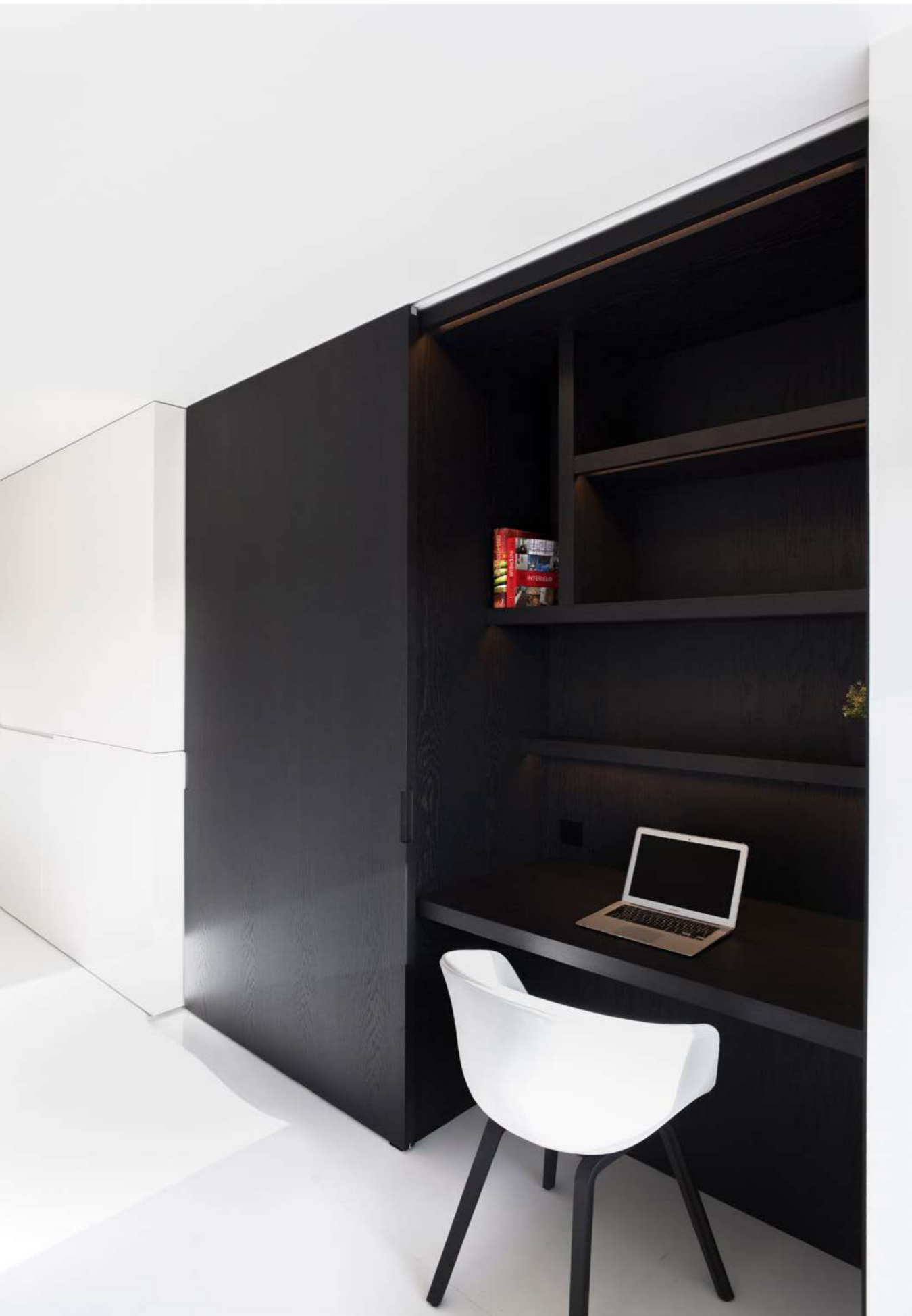

argenta
LATENT
 80 - 120 KG

The track is concealed within a 12.5 mm plasterboard ceiling, only showing a narrow groove once finished. Latent is always combined with compact superior fittings, which enables you to adjust the clearance between the door and running profile down to only 3 mm.

PROFILE LENGTH

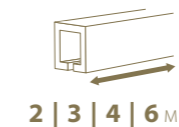

2 | 3 | 4 | 6 M

INSTALLATION



DOOR WEIGHT

MAX.
120
 KG



grey anodised
 aluminium

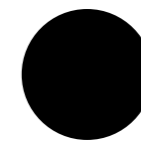

black anodised
 aluminium

Technical drawings

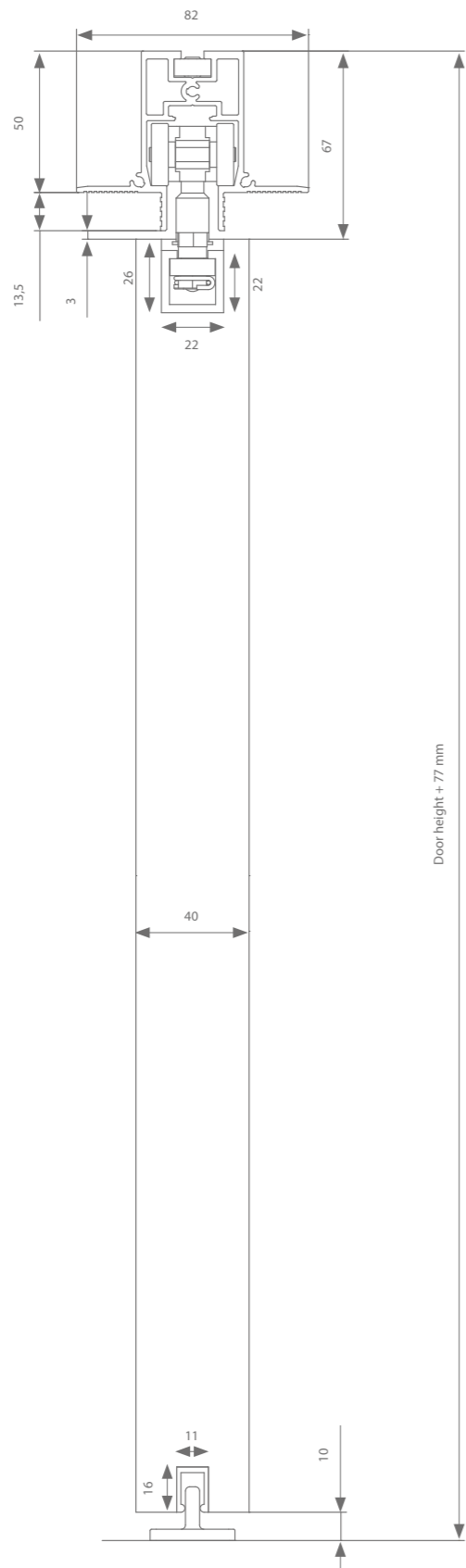

Height adjustment: + 0 / - 5 mm

TIP



The AK9.335 guide is ideal in situations where you prefer not to fix the guiding channel to the floor.

Profiles

	Max. door width	Length	Reference
Running track grey anodised aluminium	1000 mm	2000 mm	AK0.238.200
	1500 mm	3000 mm	AK0.238.300
	2000 mm	4000 mm	AK0.238.400
	3000 mm	6000 mm	AK0.238.600
Running track black anodised aluminium	1000 mm	2000 mm	AK0.232.200
	1500 mm	3000 mm	AK0.232.300
	2000 mm	4000 mm	AK0.232.400
	3000 mm	6000 mm	AK0.232.600
Suspension profile	1000 mm	1000 mm	110.828.100
	1250 mm	1250 mm	110.828.125
	1500 mm	1500 mm	110.828.150
	2000 mm	2000 mm	110.828.200
	3000 mm	3000 mm	110.828.300
+ end caps			(2x) 110.829
Guiding track	1000 mm	1000 mm	510.608.100
	1250 mm	1250 mm	510.608.125
	1500 mm	1500 mm	510.608.150
	2000 mm	2000 mm	510.608.200
	3000 mm	3000 mm	510.608.300

Fittings selection

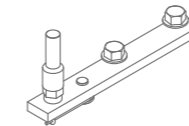

Single doors - grey anodised aluminium	Reference
Without softclose	AK0.230
With 1 softclose (min. door width = 570 mm)	AK0.230.020
With 2 softcloses (min. door width = 875 mm)	AK0.230.220
Single doors - black anodised aluminium	
Without softclose	AK0.232
With 1 softclose (min. door width = 570 mm)	AK0.232.020
With 2 softcloses (min. door width = 875 mm)	AK0.232.220
Double doors - grey anodised aluminium*	
Without softclose	AK0.230.002
With 1 softclose (min. door width = 520 mm)	AK0.230.022
With 2 softcloses (min. door width = 730 mm)	AK0.230.222
Double doors - black anodised aluminium*	
Without softclose	AK0.232.002
With 1 softclose (min. door width = 520 mm)	AK0.232.022
With 2 softcloses (min. door width = 730 mm)	AK0.232.222

Every fitting set comes with all the rollers or softclose mechanisms, suspension, guiding systems and stoppers you need.
* Double profile selection amount

Technical drawings

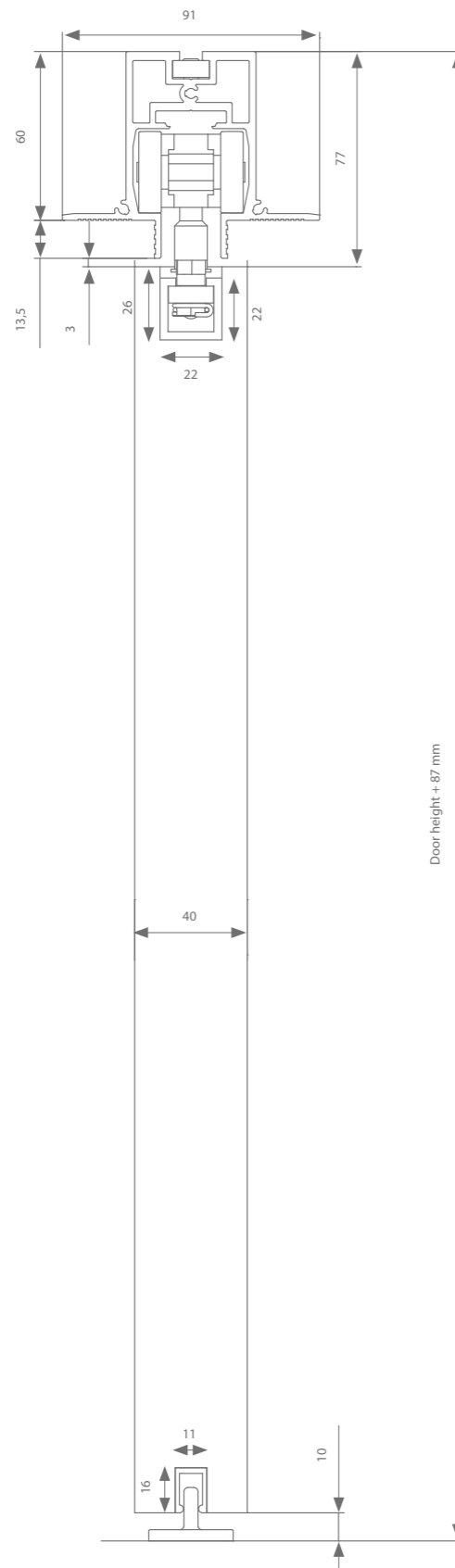

Height adjustment: + 0 / - 5 mm

Profiles

	Max. door width	Length	Reference
Running track grey anodised aluminium	1000 mm	2000 mm	AM0.238.200
	1500 mm	3000 mm	AM0.238.300
	2000 mm	4000 mm	AM0.238.400
	3000 mm	6000 mm	AM0.238.600
Running track black anodised aluminium	1000 mm	2000 mm	AM0.232.200
	1500 mm	3000 mm	AM0.232.300
	2000 mm	4000 mm	AM0.232.400
	3000 mm	6000 mm	AM0.232.600
Suspension profile	1000 mm	1000 mm	110.828.100
	1250 mm	1250 mm	110.828.125
	1500 mm	1500 mm	110.828.150
	2000 mm	2000 mm	110.828.200
	3000 mm	3000 mm	110.828.300
+ end caps			(2x) 110.829
Guiding track	1000 mm	1000 mm	510.608.100
	1250 mm	1250 mm	510.608.125
	1500 mm	1500 mm	510.608.150
	2000 mm	2000 mm	510.608.200
	3000 mm	3000 mm	510.608.300

Fittings selection

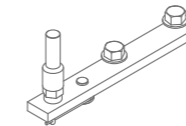

Single doors - grey anodised aluminium	Reference
Without softclose	AM0.230
With 1 softclose (min. door width = 665 mm)	AM0.230.020
With 2 softcloses (min. door width = 1010 mm)	AM0.230.220
Single doors - black anodised aluminium	
Without softclose	AM0.232
With 1 softclose (min. door width = 665 mm)	AM0.232.020
With 2 softcloses (min. door width = 1010 mm)	AM0.232.220
Double doors - grey anodised aluminium*	
Without softclose	AM0.230.002
With 1 softclose (min. door width = 600 mm)	AM0.230.022
With 2 softcloses (min. door width = 820 mm)	AM0.230.222
Double doors - black anodised aluminium*	
Without softclose	AM0.232.002
With 1 softclose (min. door width = 600 mm)	AM0.232.022
With 2 softcloses (min. door width = 820 mm)	AM0.232.222

Every fitting set comes with all the rollers or softclose mechanisms, suspension, guiding systems and stoppers you need.
* Double profile selection amount



04

HIDE TIMBER

The minimalist sliding door system that is concealed into a 12,5 mm plasterboard suspended ceiling consists a fixed recessed mother profile and a removable running track.

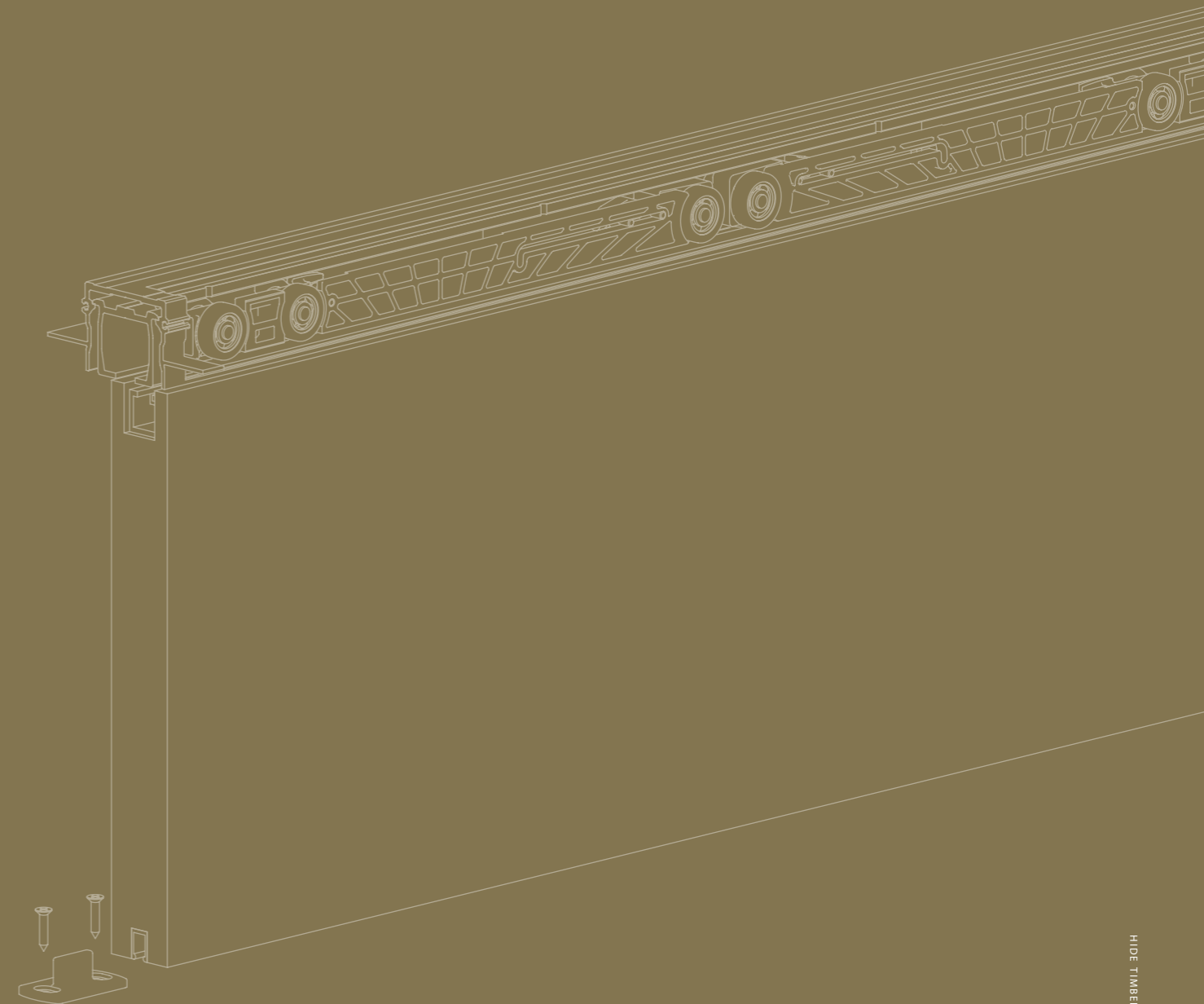



argenta
HIDE
 80 - 120 KG

This system is both discreet and user-friendly as the rollers, stoppers and softcloses remain accessible at all times. Hide is always combined with compact superior fittings for a limited clearance of only 3 mm between the door and the track.

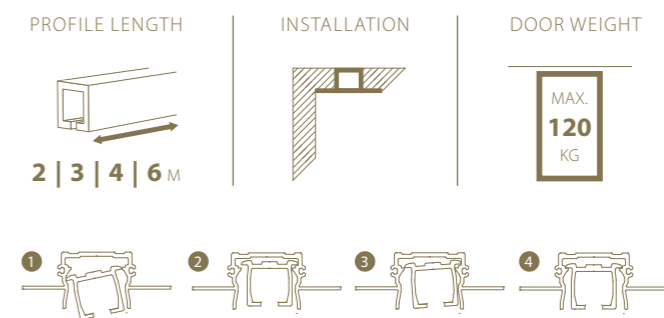

grey anodised
aluminium

Technical drawing

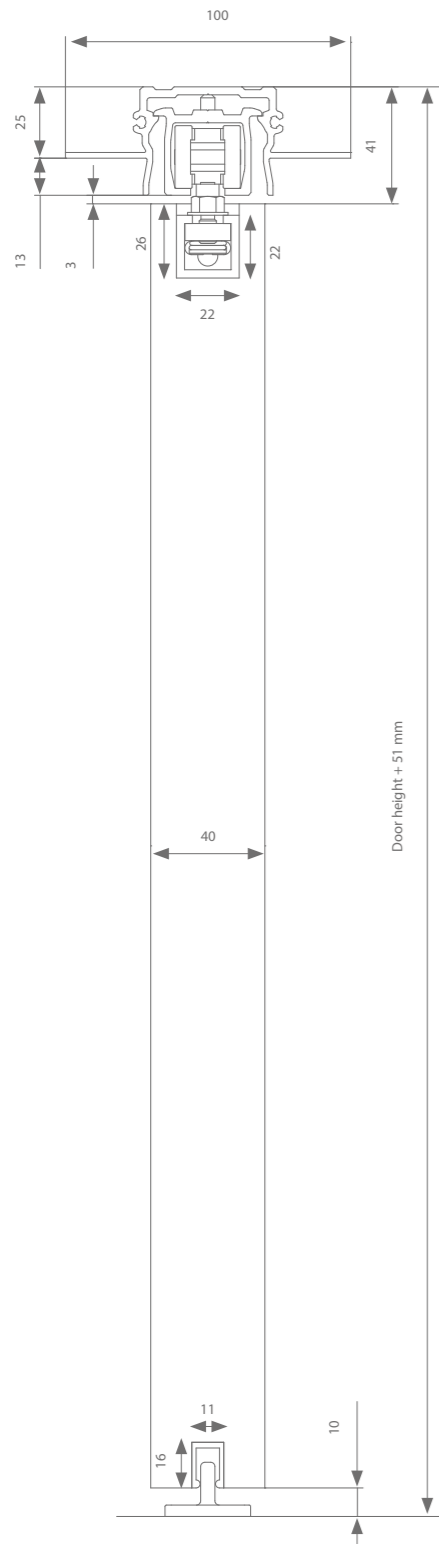

Height adjustment: + 0 / - 5 mm

Profiles

	Max. door width	Length	Reference
Built-in profile + running track + removable part (70 mm)	1000 mm	2000 mm	AK0.288.200
	1500 mm	3000 mm	AK0.288.300
	2000 mm	4000 mm	AK0.288.400
	3000 mm	6000 mm	AK0.288.600
Suspension profile		236 mm	(2x) 110.828
	1000 mm	1000 mm	110.828.100
	1250 mm	1250 mm	110.828.125
	1500 mm	1500 mm	110.828.150
	2000 mm	2000 mm	110.828.200
+ end caps			(2x) 110.829
	3000 mm	3000 mm	110.828.300
Guiding track	1000 mm	1000 mm	510.608.100
	1250 mm	1250 mm	510.608.125
	1500 mm	1500 mm	510.608.150
	2000 mm	2000 mm	510.608.200
	3000 mm	3000 mm	510.608.300

Fittings selection

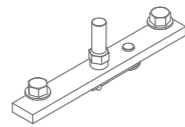

Compact suspension	Reference
Without softclose	AK0.808
With 1 softclose (min. door width = 502 mm)	AK0.808.020
With 2 softcloses (min. door width = 737 mm)	AK0.808.220

Every fitting set comes with all the rollers or softclose mechanisms, suspension, guiding systems and stoppers you need.

TIP

The AK9.335 guide is ideal in situations where you prefer not to fix the guiding channel to the floor.

Technical drawing

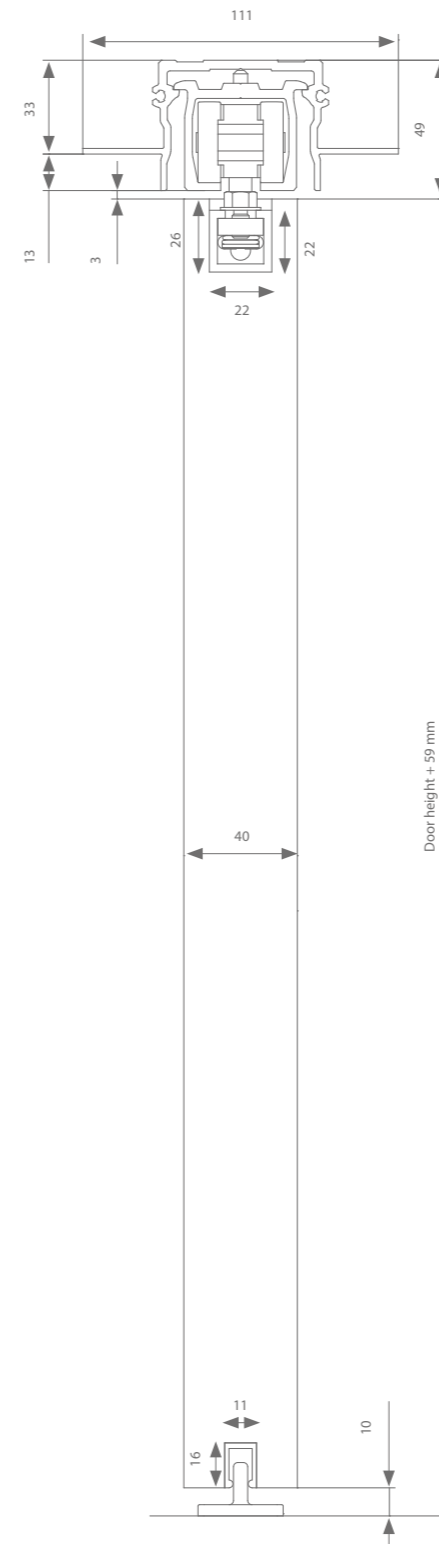

Height adjustment: + 0 / - 5 mm

Profiles

	Max. door width	Length	Reference
Built-in profile + running track + removable part (70 mm)	1000 mm	2000 mm	AM0.288.200
	1500 mm	3000 mm	AM0.288.300
	2000 mm	4000 mm	AM0.288.400
	3000 mm	6000 mm	AM0.288.600
Suspension profile		236 mm	(2x) 110.828
	1000 mm	1000 mm	110.828.100
	1250 mm	1250 mm	110.828.125
	1500 mm	1500 mm	110.828.150
	2000 mm	2000 mm	110.828.200
+ end caps			(2x) 110.829
	3000 mm	3000 mm	110.828.300
Guiding track	1000 mm	1000 mm	510.608.100
	1250 mm	1250 mm	510.608.125
	1500 mm	1500 mm	510.608.150
	2000 mm	2000 mm	510.608.200
	3000 mm	3000 mm	510.608.300

Fittings selection

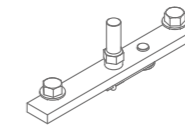

Compact suspension	Reference
Without softclose	AM0.808
With 1 softclose (min. door width = 562 mm)	AM0.808.020
With 2 softcloses (min. door width = 807 mm)	AM0.808.220

Every fitting set comes with all the rollers or softclose mechanisms, suspension, guiding systems and stoppers you need.



05

EXPERT SYMMETRICAL TIMBER

As an addition to the expert series, argenta® offers a symmetrical system to close off wider passages in an aesthetically pleasing and ergonomic way.

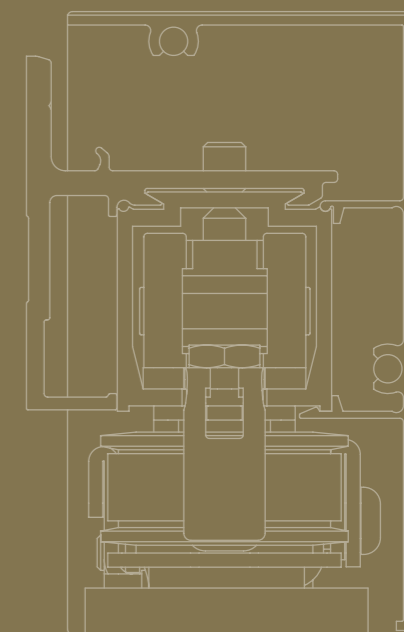



argenta
EXPERT
SYMMETRICAL 80 - 120 KG

Both doors are connected by a reinforced belt that coordinates their simultaneous movement. User comfort is guaranteed in every situation: both door panels can be opened or closed with just one finger! Both ceiling and wall mounting options are available.

PROFILE LENGTH

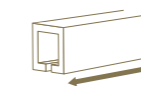

2 | 3 | 4 | 6 M

INSTALLATION



DOOR WEIGHT

MAX.
120
KG

Technical drawing

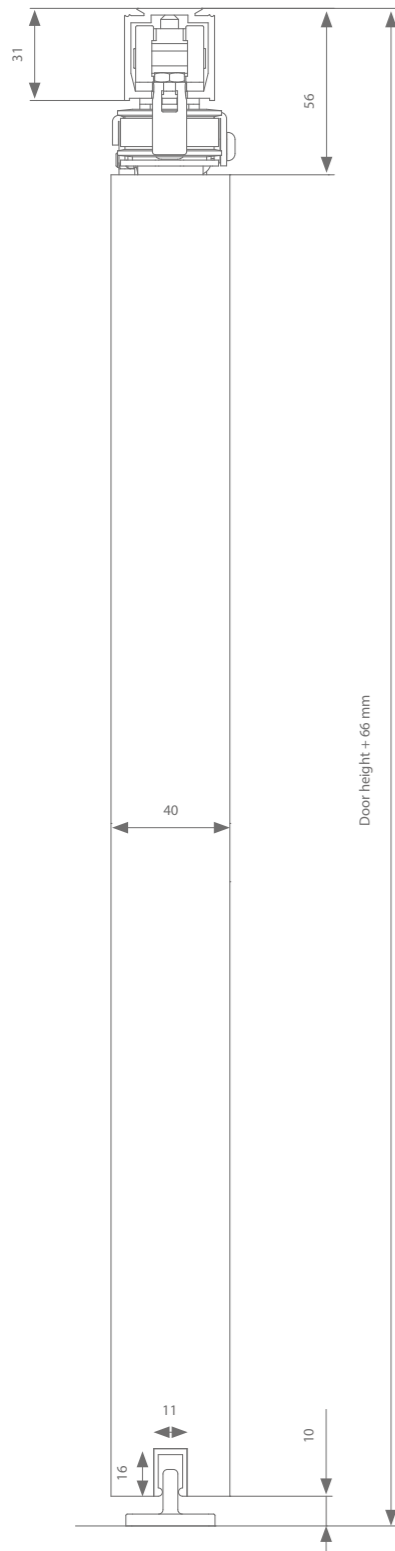

Height adjustment: +/- 3 mm Min. clearance = 950 mm - Max. clearance = 2900 mm

Profiles

	Max. door width	Length	Reference
Running track	500 mm	2000 mm	AK0.208.200
	750 mm	3000 mm	AK0.208.300
	1000 mm	4000 mm*	AK0.208.400*
	1500 mm	6000 mm*	AK0.208.600*
Guiding track	1000 mm	1000 mm	(2x) 510.608.100
	1250 mm	1250 mm	(2x) 510.608.125
	1500 mm	1500 mm	(2x) 510.608.150

Fittings selection

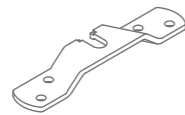

Transverse suspension	Reference
Without softclose	AK0.701

Every fitting set comes with all the rollers, suspension, guiding systems and stoppers you need.

Belt

	Length	Reference
Min. belt length = (4 x door width) x 2 + 200 mm	50 m	AK9.709.050
	20 m	AK9.709.020
	10 m	AK9.709.010

*Belt balancer (prevents belt sagging)

Profile length > 4000 mm AK0.741.1

TIP



The AK9.335 guide is ideal in situations where you prefer not to fix the guiding channel to the floor.

Technical drawing

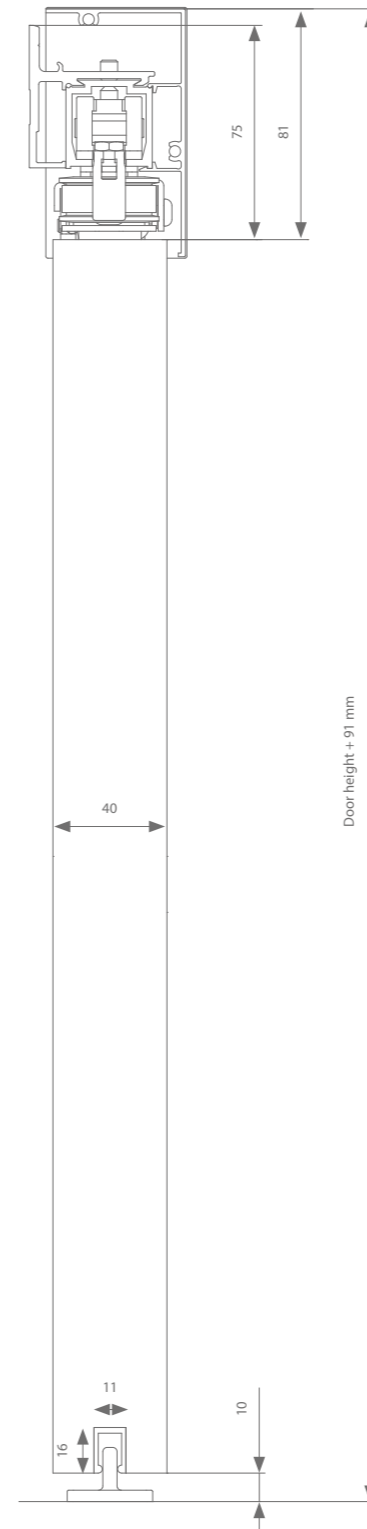

Height adjustment: +/- 3 mm Min. clearance = 950 mm - Max. clearance = 2900 mm

Profiles

	Max. door width	Length	Reference
Running track	500 mm	2000 mm	AK0.208.200
	750 mm	3000 mm	AK0.208.300
	1000 mm	4000 mm*	AK0.208.400*
	1500 mm	6000 mm*	AK0.208.600*
Wall bracket	Required every 500 - 600 mm		AK1.138.0
Cover profile	500 mm	2000 mm	AK9.708.200
	750 mm	3000 mm	AK9.708.300
	1000 mm	4000 mm	AK9.708.400
	1500 mm	6000 mm	AK9.708.600
+ end caps			AK9.708
Guiding track	1000 mm	1000 mm	(2x) 510.608.100
	1250 mm	1250 mm	(2x) 510.608.125
	1500 mm	1500 mm	(2x) 510.608.150

Fittings selection

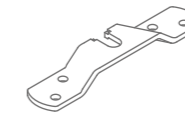

Transverse suspension	Reference
Without softclose	AK0.701

Every fitting set comes with all the rollers, suspension, guiding systems and stoppers you need.

Belt

	Length	Reference
Min. belt length = (4 x door width) x 2 + 200 mm	50 m	AK9.709.050
	20 m	AK9.709.020
	10 m	AK9.709.010

*Belt balancer (prevents belt sagging)

Profile length > 4000 mm AK0.741.1

TIP



The AK9.335 guide is ideal in situations where you prefer not to fix the guiding channel to the floor.

argenta symmetrical 120 kg
ceiling mounting

assemble your set 

Technical drawing

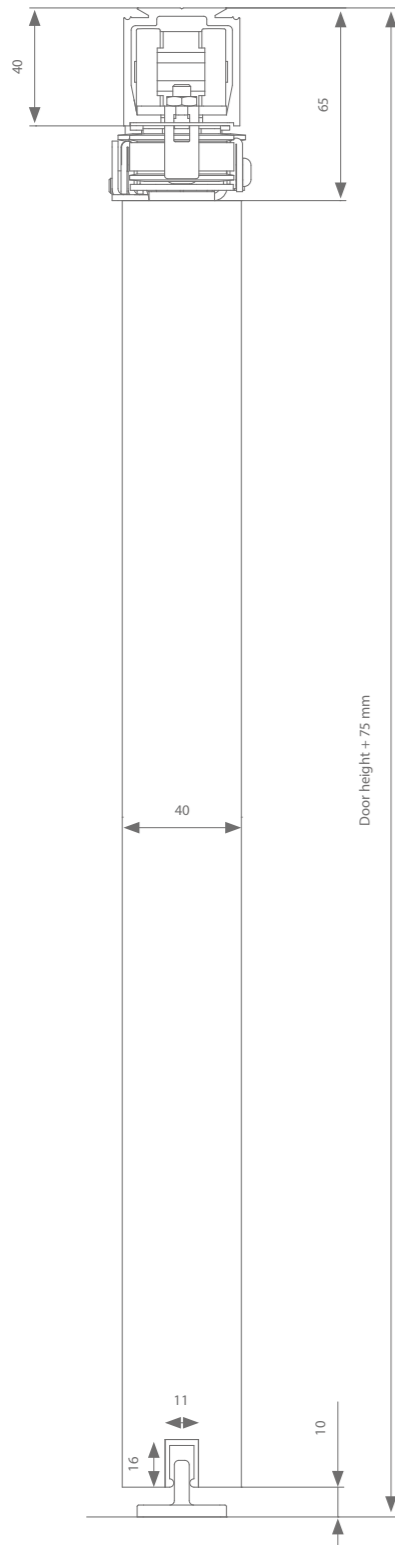

Profiles

	Max. door width	Length	Reference
Running track	500 mm	2000 mm	AM0.208.200
	750 mm	3000 mm	AM0.208.300
	1000 mm	4000 mm*	AM0.208.400*
	1500 mm	6000 mm*	AM0.208.600*
Guiding track	1000 mm	1000 mm	(2x) 510.608.100
	1250 mm	1250 mm	(2x) 510.608.125
	1500 mm	1500 mm	(2x) 510.608.150

Fittings selection

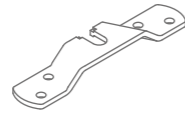

Transverse suspension	Reference
Without softclose	AM0.701

Every fitting set comes with all the rollers, suspension, guiding systems and stoppers you need.

Belt

	Length	Reference
Min. belt length =	50 m	AK9.709.050
(4 x door width) x 2 + 200 mm	20 m	AK9.709.020
	10 m	AK9.709.010

*Belt balancer

(prevents belt sagging)
Profile length > 4000 mm AK0.741.1

Height adjustment: +/- 5 mm Min. clearance = 950 mm - Max. clearance = 2900 mm

argenta symmetrical 120 kg
wall mounting

assemble your set 

Technical drawing

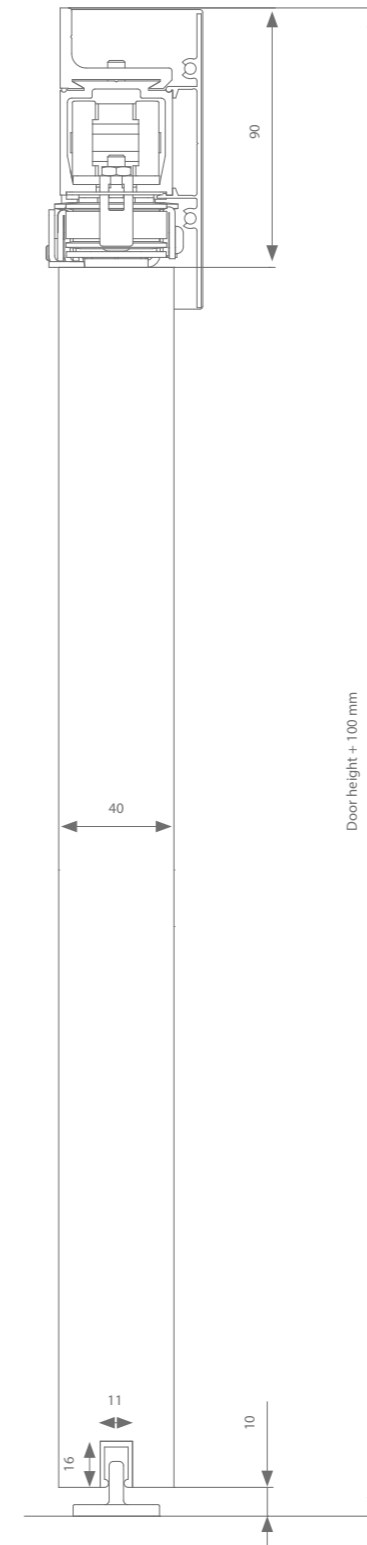

Profiles

	Max. door width	Length	Reference
Running track	500 mm	2000 mm	AM0.208.200
	750 mm	3000 mm	AM0.208.300
	1000 mm	4000 mm*	AM0.208.400*
	1500 mm	6000 mm*	AM0.208.600*
Wall bracket	Required every 500 - 600 mm		AM1.118.0
Cover profile	500 mm	2000 mm	AM0.938.200
	750 mm	3000 mm	AM0.938.300
	1000 mm	4000 mm	AM0.938.400
	1500 mm	6000 mm	AM0.938.600
+ end caps			AM9.938
Guiding track	1000 mm	1000 mm	(2x) 510.608.100
	1250 mm	1250 mm	(2x) 510.608.125
	1500 mm	1500 mm	(2x) 510.608.150

Fittings selection

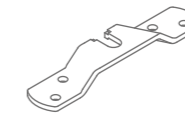

Transverse suspension	Reference
Without softclose	AM0.701

Every fitting set comes with all the rollers, suspension, guiding systems and stoppers you need.

Belt

	Length	Reference
Min. belt length =	50 m	AK9.709.050
(4 x door width) x 2 + 200 mm	20 m	AK9.709.020
Min. belt length =	10 m	AK9.709.010
(4 x door width) x 2 + 200 mm	(number of metres) x AK9.709.001	

*Belt balancer

(prevents belt sagging)
Profile length > 4000 mm AK0.741.1

Height adjustment: +/- 5 mm Min. clearance = 950 mm - Max. clearance = 2900 mm



06

EXPERT TELESCOPIC TIMBER

The telescopic system makes it perfectly possible to divide rooms using 2 or 3 door panels that are compactly bundled together alongside a narrow wall.

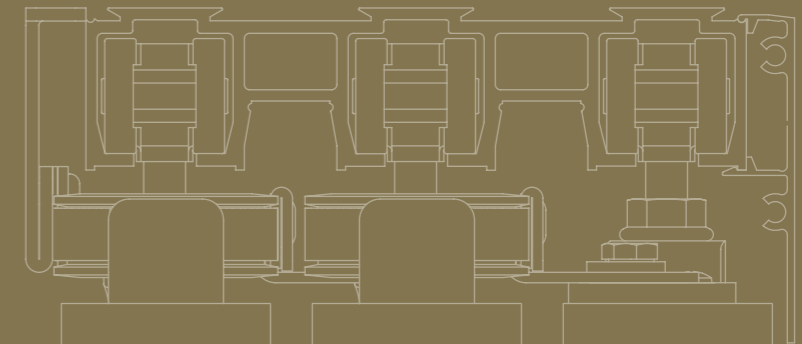



argenta
EXPERT
 TELESCOPIC 80 KG

This silent system is available in 2 variants, with a belt or with carriers. In the belt driven version, all doors move simultaneously so that they reach their end point at the same time. A reinforced belt is joined to the door and tensioned using a belt tensioner. Proper belt tension is required for optimal operation. In the second variant, carriers move one panel after the other.

PROFILE LENGTH

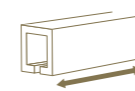

2 | 3 | 4 | 6 M

INSTALLATION



DOOR THICKNESS



40
MM

DOOR WEIGHT



MAX.
80
KG

Technical drawings

Carrier version

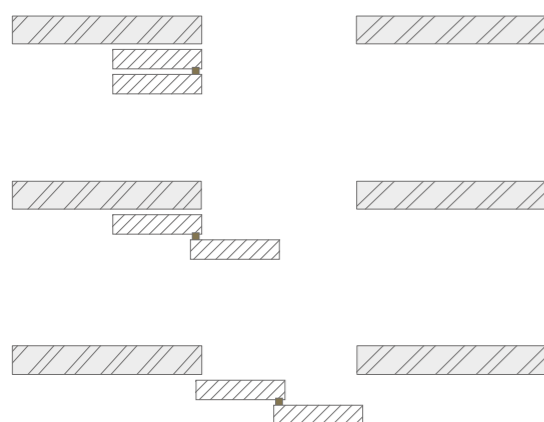

Belt version

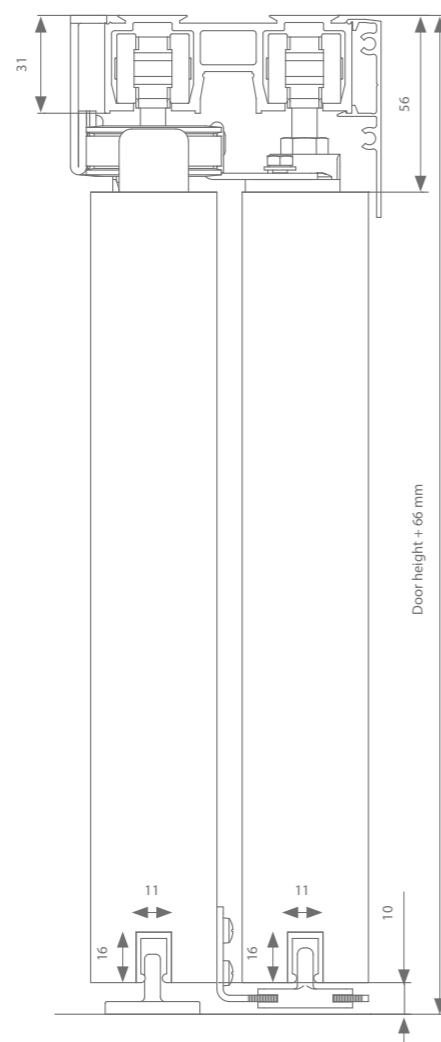
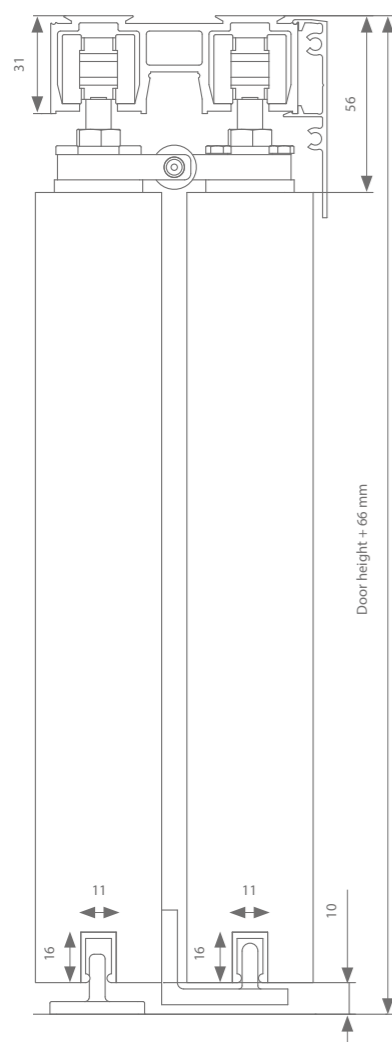
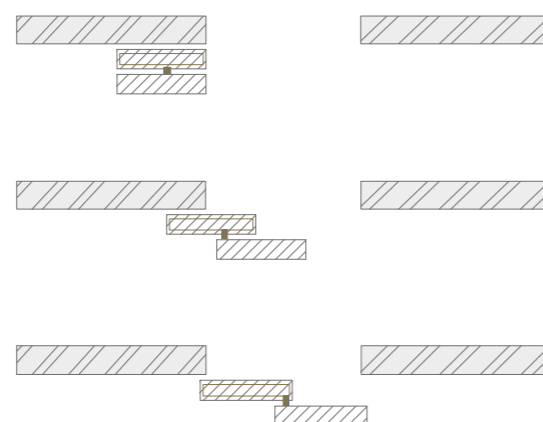

Height adjustment: + / - 3 mm

Min. clearance = 1120 mm - Max. clearance = 3900 mm

Profiles

	Max. door width	Length	Reference
Running track	667 mm	2000 mm	AK0.202.200
	1000 mm	3000 mm	AK0.202.300
	1334 mm	4000 mm	AK0.202.400
	2000 mm	6000 mm	AK0.202.600
Cover profile	667 mm	2000 mm	AK0.948.200
	1000 mm	3000 mm	AK0.948.300
	1334 mm	4000 mm	AK0.948.400
	2000 mm	6000 mm	AK0.948.600
Guiding track	1000 mm	1000 mm	(2x) 510.608.100
	1250 mm	1250 mm	(2x) 510.608.125
	1500 mm	1500 mm	(2x) 510.608.150
	2000 mm	2000 mm	(2x) 510.608.200

Fittings selection

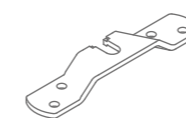

Transverse suspension	Reference
Carrier version - Without softclose	AK0.202
Belt version - Without softclose	AK0.801

Every fitting set comes with all the rollers, suspension, guiding systems and stoppers you need.

Belt (only required in belt version)

	Length	Reference
Min. belt length = 2 x door width + 500 mm	50 m	AK9.709.050
	20 m	AK9.709.020
	10 m	AK9.709.010

TIP

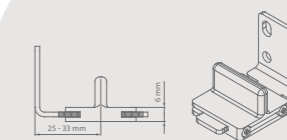

The AK9.335 guide is ideal in situations where you prefer not to fix the guiding channel to the floor.

Technical drawings

Carrier version

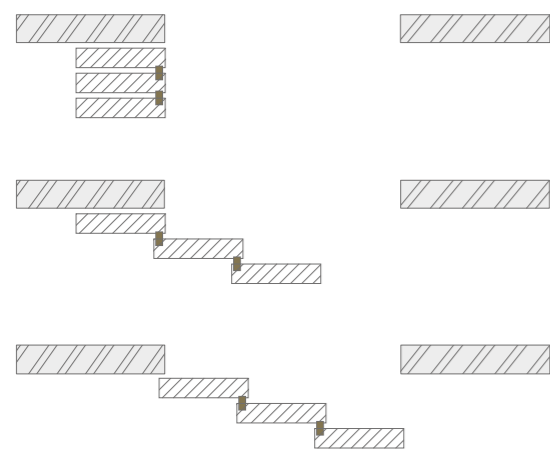

Belt version

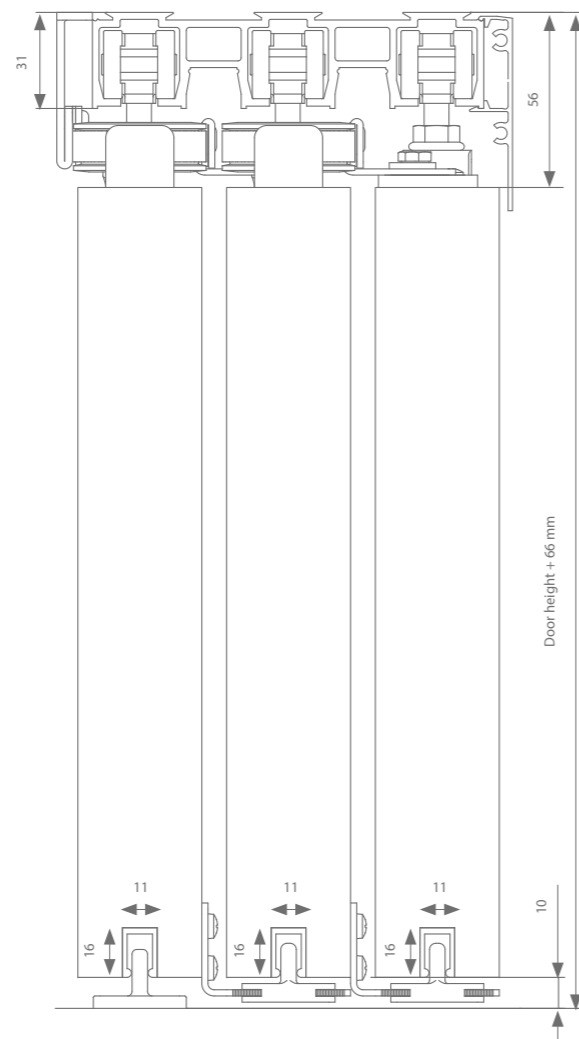
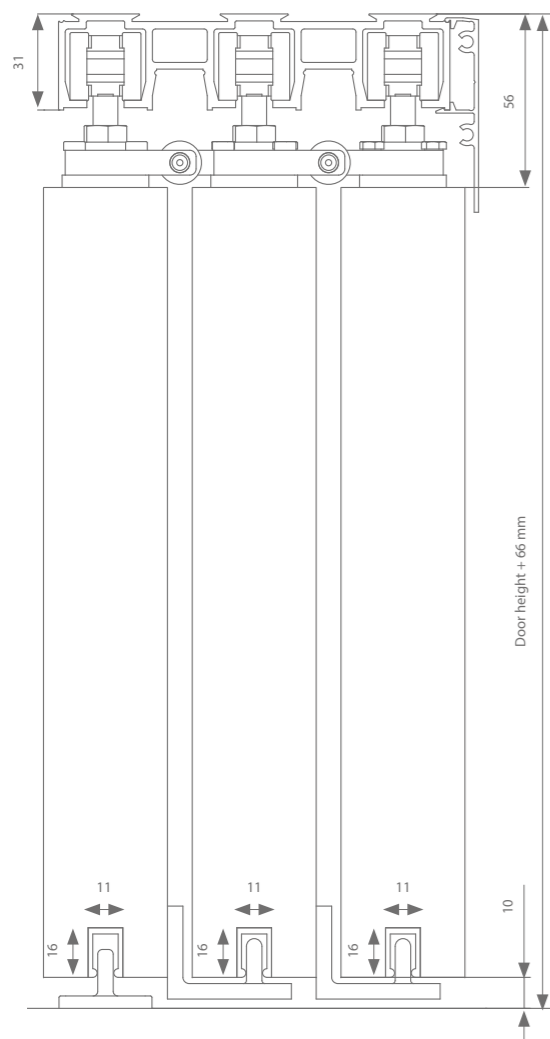
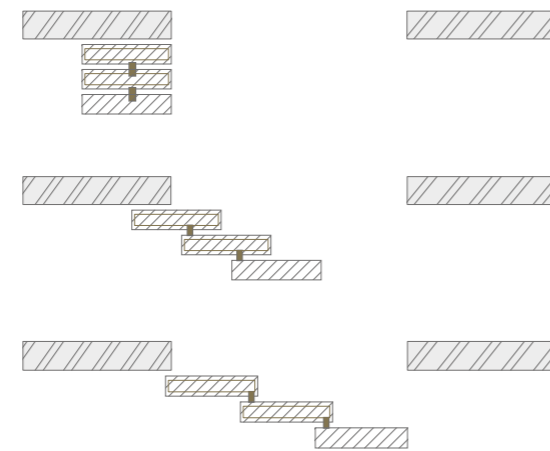

Height adjustment: + / - 3 mm Min. clearance = 1680 mm - Max. clearance = 4400 mm

Profiles

	Max. door width	Length	Reference
Running track	500 mm	2000 mm	AK0.203.200
	750 mm	3000 mm	AK0.203.300
	1000 mm	4000 mm	AK0.203.400
	1500 mm	6000 mm	AK0.203.600
Cover profile	500 mm	2000 mm	AK0.948.200
	750 mm	3000 mm	AK0.948.300
	1000 mm	4000 mm	AK0.948.400
	1500 mm	6000 mm	AK0.948.600
Guiding track	1000 mm	1000 mm	(3x) 510.608.100
	1250 mm	1250 mm	(3x) 510.608.125
	1500 mm	1500 mm	(3x) 510.608.150

Fittings selection

Transverse suspension	Reference
Carrier version - Without softclose	AK0.203
Belt version - Without softclose	AK0.831

Every fitting set comes with all the rollers, suspension, guiding systems and stoppers you need.

Belt (only required in belt version)

	Length	Reference
Min. belt length = 2 x ((2 x door width) + 500 mm)	50 m	AK9.709.050
	20 m	AK9.709.020
	10 m	AK9.709.010

TIP



The AK9.335 guide is ideal in situations where you prefer not to fix the guiding channel to the floor.



07

FOLD TIMBER

Fold offers a space-saving solution for cabinet and interior doors when a standard hinged or sliding door takes up too much space.

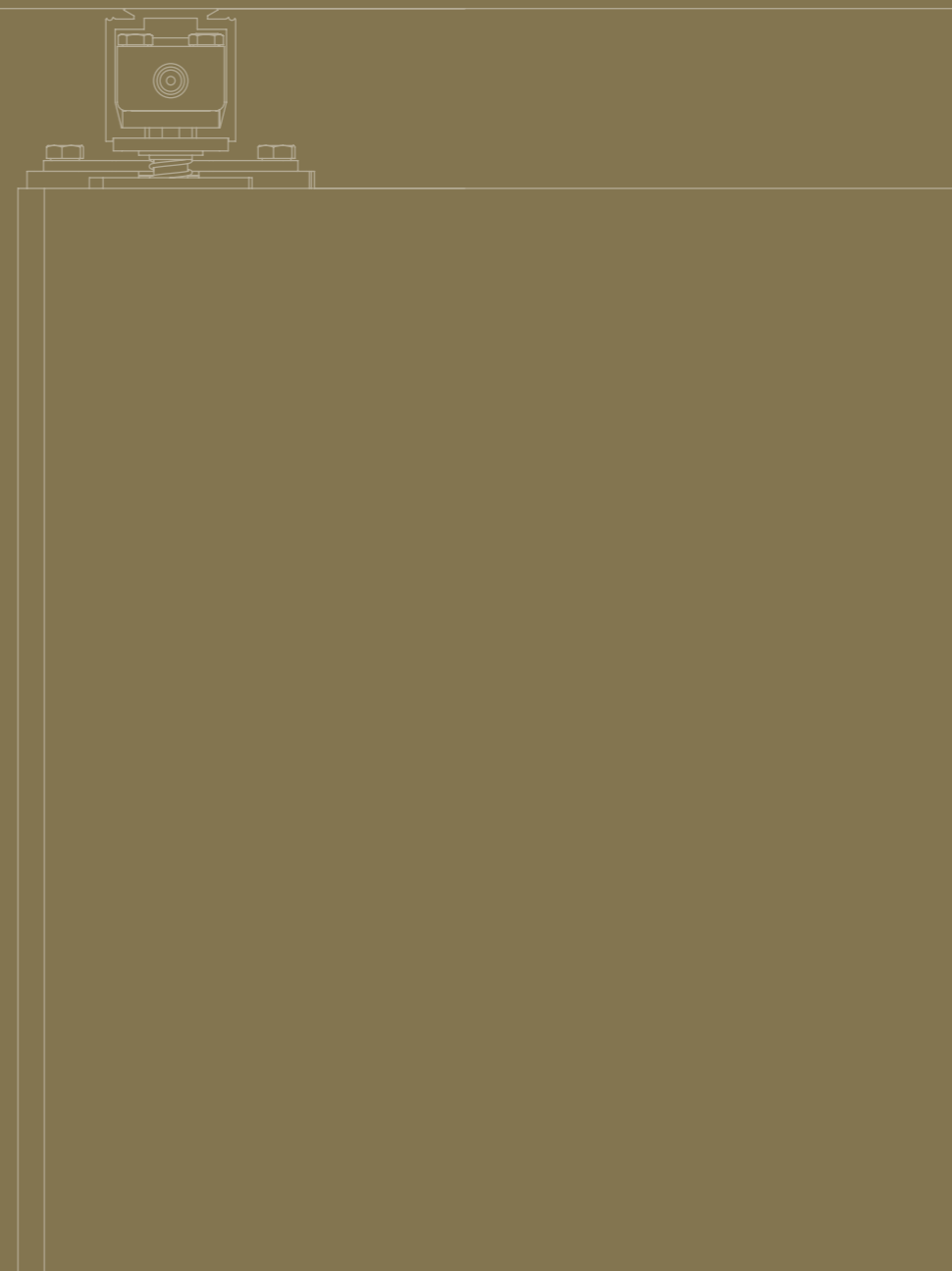

assemble your set 
2 x 40 kg ceiling mounting

argenta
FOLD
80 KG

The system does not require any bottom guiding system and comes equipped with invisible hinges; in brief, it adds elegance to any interior.

DOOR WIDTH



INSTALLATION



DOOR THICKNESS



DOOR WEIGHT
PER PANEL

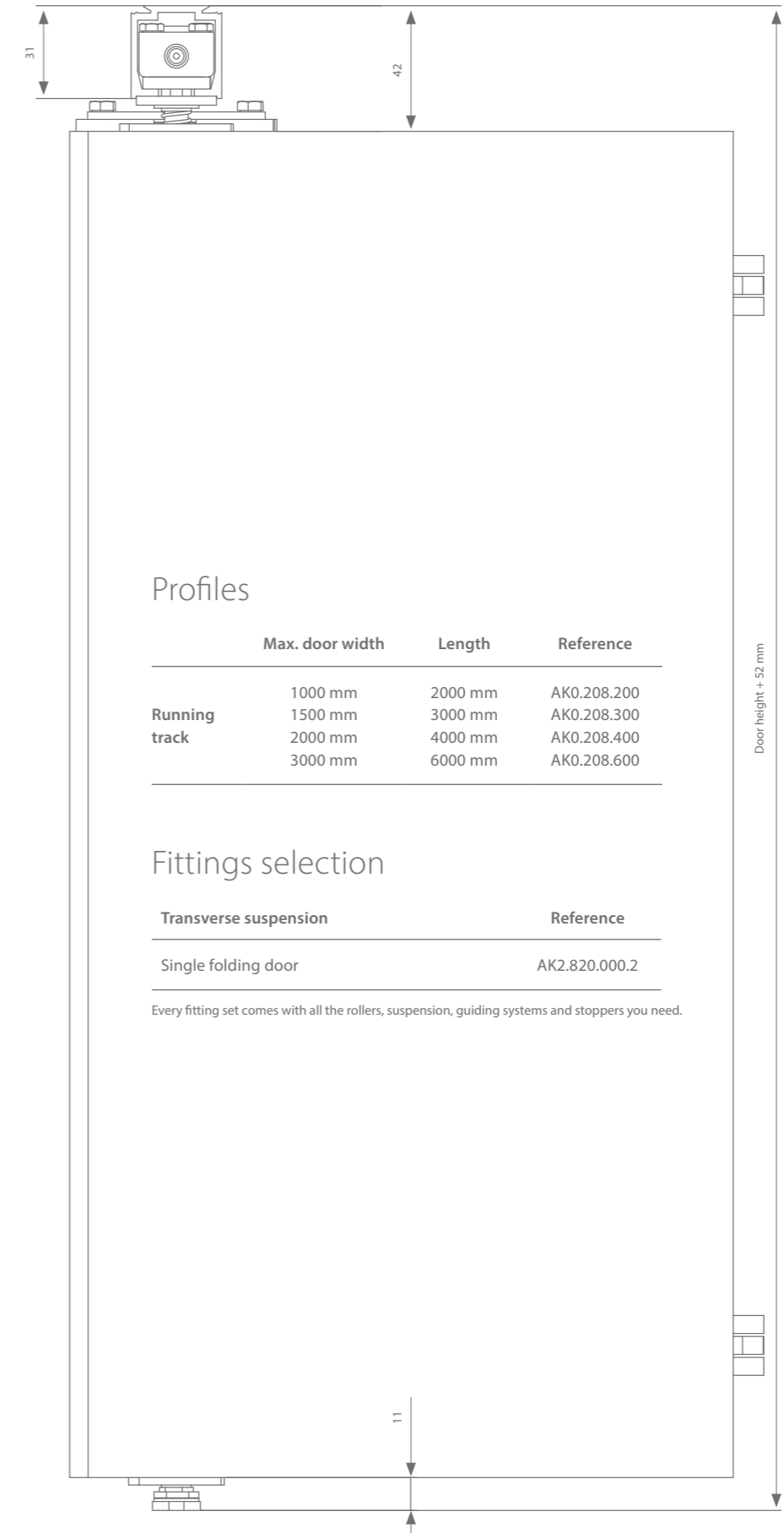

Profiles

	Max. door width	Length	Reference
Running track	1000 mm	2000 mm	AK0.208.200
	1500 mm	3000 mm	AK0.208.300
	2000 mm	4000 mm	AK0.208.400
	3000 mm	6000 mm	AK0.208.600

Fittings selection

Transverse suspension	Reference
Single folding door	AK2.820.000.2

Every fitting set comes with all the rollers, suspension, guiding systems and stoppers you need.

PRODUCT CONFIGURATOR TIMBER

Order sequence	40 kg	80 kg	80 kg S	120 kg	200 kg	
1 Running profile						
	2 m	AG0.208.200	AK0.208.200	AK0.208.200	AM0.208.200	AP0.208.200
	3 m	AG0.208.300	AK0.208.300	AK0.208.300	AM0.208.300	AP0.208.300
	4 m	AG0.208.400	AK0.208.400	AK0.208.400	AM0.208.400	AP0.208.400
	6 m	AG0.208.600	AK0.208.600	AK0.208.600	AM0.208.600	AP0.208.600
2 Cover profile	Ceiling mounting					
	2 m	AK0.948.200	AK0.948.200	AK0.948.200	AM0.948.200	/
	3 m	AK0.948.300	AK0.948.300	AK0.948.300	AM0.948.300	/
	4 m	AK0.948.400	AK0.948.400	AK0.948.400	AM0.948.400	/
	6 m	AK0.948.600	AK0.948.600	AK0.948.600	AM0.948.600	/
	+ set of end caps	AK9.948	AK9.948	AK9.948	AM9.948	/
	Wall mounting					
	2 m	choice between AK0.938.200 or AK9.708.200			AM0.938.200	/
	3 m	choice between AK0.938.300 or AK9.708.300			AM0.938.300	/
	4 m	choice between AK0.938.400 or AK9.708.400			AM0.938.400	/
6 m	choice between AK0.938.600 or AK9.708.600			AM0.938.600	/	
+ set of end caps	choice between AK9.938 or AK9.708			AM9.938	/	
3 Wall mounting: wall bracket	To be fitted every 50 - 60 cm					
		AK1.118.0	AK1.118.0	AK1.118.0	AM1.118.0	AP1.118.0
4 Bottom guiding profile						
	1 m	510.608.100	510.608.100	510.608.100	510.608.100	510.608.100
	1,25 m	510.608.125	510.608.125	510.608.125	510.608.125	510.608.125
	1,5 m	510.608.150	510.608.150	510.608.150	510.608.150	510.608.150
	2 m	510.608.200	510.608.200	510.608.200	510.608.200	510.608.200
	3 m	510.608.300	510.608.300	510.608.300	510.608.300	510.608.300
	4 m	510.608.400	510.608.400	510.608.400	510.608.400	510.608.400
6 m	510.608.600	510.608.600	510.608.600	510.608.600	510.608.600	

Order sequence	40 kg	80 kg	80 kg S	120 kg	200 kg	
5A Compact fittings*	1. Suspension profile					
	236 mm	(2x)110.828	(2x) 110.828	(2x) 110.828	(2x) 110.828	/
	1 m	110.828.100	110.828.100	110.828.100	110.828.100	/
	1,25 m	110.828.125	110.828.125	110.828.125	110.828.125	/
	1,5 m	110.828.150	110.828.150	110.828.150	110.828.150	/
	2 m	110.828.200	110.828.200	110.828.200	110.828.200	/
	3 m	110.828.300	110.828.300	110.828.300	110.828.300	/
	4 m	110.828.400	110.828.400	110.828.400	110.828.400	/
	6 m	110.828.600	110.828.600	110.828.600	110.828.600	/
	2. Sealing part					
2 x required	110.829	110.829	110.829	110.829	/	
3. Fittings						
Without softclose	AG0.308	AK0.308	AK0.808	AM0.808	/	
With 1 softclose	AG0.308.020	AK0.308.020	AK0.808.020	AM0.808.020	/	
With 2 softcloses	AG0.308.220	/	AK0.808.220	AM0.808.220	/	
5B Non-compact fittings*						
	Without softclose	AG0.100	AK0.100	AK0.600	AM0.600	AP0.600
	With 1 softclose	AG0.100.020	AK0.100.020	AK0.600.020	AM0.600.020	/
	With 2 softcloses	AG0.100.220	/	AK0.600.220	AM0.600.220	/
	Without softclose	AG0.106	AK0.106	AK0.606	AM0.606	/
	Without softclose	AG0.102	AK0.102	AK0.602	/	/
	With 1 softclose	AG0.102.020	AK0.102.020	/	/	/
	With 2 softcloses	AG0.102.220	AK0.102.220	/	/	/

Door width

	Compact suspension		Non-compact suspension	
	1 softclose	2 softclose	1 softclose	2 softclose
Expert 40 - 80 kg	502 mm	737 mm	494 mm	724 mm
Expert 120 kg	552 mm	787 mm	545 mm	774 mm



Ter Vlucht 2 +32 (0)51 27 05 00
8850 Ardoorie info@arlu.be
Belgium WWW.ARLU.BE



©L3000022 03/24 English