



POCKET & LATENT POCKET



 **argenta**

OPENING DOORS



ALL TECHNICAL DRAWINGS ARE SHOWN IN MILLIMETRES AND ARE SUBJECT TO CHANGE BY ARLU.

ARLU, THE REFERENCE FOR OPENING DOORS

ARLU® is the manufacturer behind the brand names argenta® and rob®. Argenta has been a leading brand in door hardware for over 100 years, but today it is mainly synonymous with invisible door systems.

Minimalist architecture swears by clean lines and a “back to the essence” mentality. In terms of interior doors, this results in integrated door fittings, invisible integrated techniques, door frames and skirting boards for revolving, sliding and pivoting doors

Argenta stands for a full range of sleek interior solutions.

01

POCKET

The pocket door combines the expert sliding systems with a metal/aluminium frame, with the door sliding into the wall completely. The system is finished with plasterboard and has a removable track. This ensures a sober and aesthetic finish without the need to install a door frame. Applications for door weights of max. 80 kg or 120 kg for different wall thicknesses; standard door heights or adjustable to ceiling height. This system is supplied with special brackets to attach above the lintel if you choose to install it in masonry walls.

01 POCKET

- 6 pocket 80 kg
- 36 pocket 120 kg
- 46 pocket corner setup
- 48 pocket glass 80 kg
- 54 pocket glass 120 kg
- 60 slam post
- 62 unislide pocket

02 LATENT POCKET

- 68 latent pocket 80 kg
- 78 latent pocket 120 kg



argenta pocket
general info

Lower door height

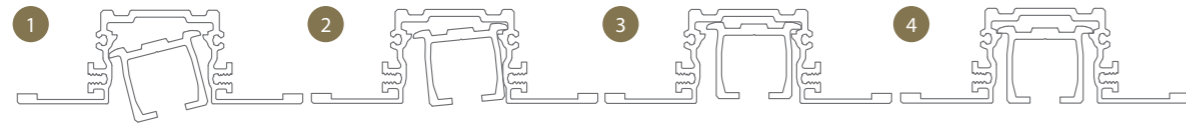

Ceiling-high door height

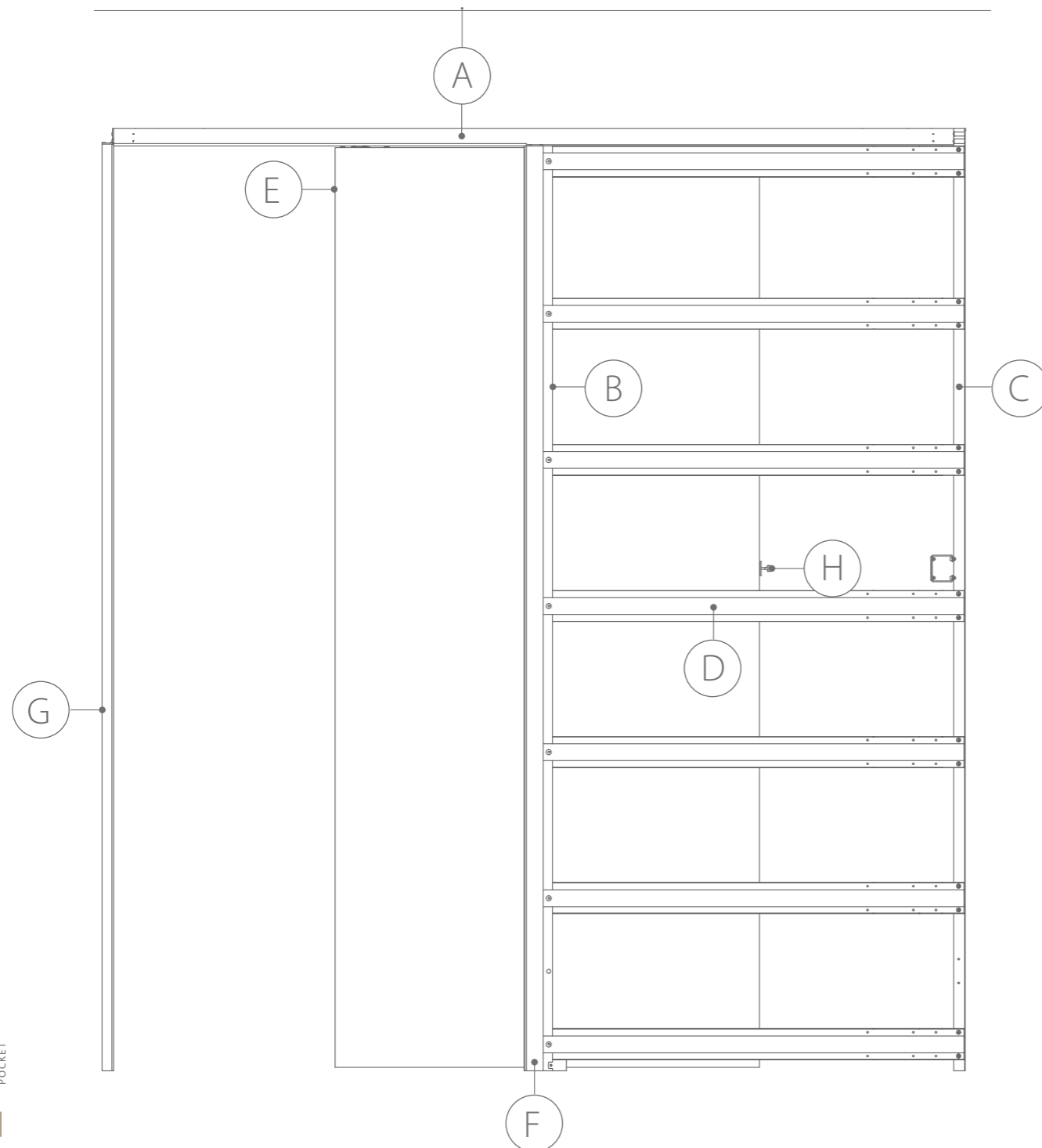

A The upper part always consists of two profiles: the outer casing track for securing and a running track that can always be removed. The casing profile comes in a version for lower door heights or a version for ceiling high doors. Thanks to the detachable running track, all roller systems are accessible at any time without causing any damage to the wall or ceiling. Rollers with stoppers or soft-close systems in both directions are therefore always accessible at all times.

B The door moves between two aluminium jambs. They fit perfectly with the plasterboard and the finish is flush with the door opening. Extra attention was paid to the strength of these jambs in the design in order to achieve an extremely strong wall.

C The assembly of the rear post with the upper profile, together with the bottom bracket, assures the sturdiness of the cassette.

D The many cross rails create a solid wall on which the plasterboard can be screwed or glued upon; no pre-drilling is required.

E A patented system for compact suspension has been integrated into this product. A suspension track is built into the top of the door leaf allowing to level the door up to 3mm under the running track.

F The floor guide can be placed at any height. This means that the pocket can be completely finished with skirting, any frames and painting. Only when the floor is finished and it's final level is known, will the floor guide be mounted and the door suspended in the system.

G Optionally, a slam post can be added. By interrupting it's central rubber seal you can install a catch.

H If you wish to hide the door completely in the cavity, you can opt for an auto-eject. A small push on the door edge will make it jump into the opening, ready to grab the pull handle and close it completely.

This pocket system can also be used to solve double doors situations, where the left and right doors slide into a wall.

Each solution can be extended with a glass package to clamp door thicknesses of 8, 10, or 12 mm and create a minimalist finish in the current pocket.



argenta
POCKET 80 KG
FOR WOODEN DOORS

All door heights fit into a dry lining wall with a thickness of 100/115,125 or 160 mm with a maximum door weight of 80 kg. Ceiling high doors only fit into a 125 mm wall. All standard dimensions have already been prepared in a standard bundle of profiles. You then only have to make the choice for the fitting and possibly an auto-eject

argenta pocket 80 kg

single-pocket wall thickness 100/115 mm

without slam post

A bundle contains the following items:

- 1 casing profile
- 1 running track
- 1 aluminium lead jamb, left
- 1 aluminium lead jamb, right
- 1 steel wall profile
- horizontal cross rails
- accessories

Not included:

- Grey brush with a length of 2810 mm: BK0.309.281.000 (1 piece)
- Black brush with a length of 2810 mm: BK0.309.281.020 (1 piece)

Bundles

Brut	Primer	A x B : Recessed installation dimensions	C : Casing Width	D x E : Clear passage	Wooden door panel
BK0.010.073	BK0.010.073.01	1466 x 2064	766	700 x 2026	730 x 2015
BK0.010.083	BK0.010.083.01	1666 x 2064	866	800 x 2026	830 x 2015
BK0.010.093	BK0.010.093.01	1866 x 2064	966	900 x 2026	930 x 2015
BK0.010.103	BK0.010.103.01	2066 x 2064	1066	1000 x 2026	1030 x 2015
BK0.010.113	BK0.010.113.01	2266 x 2064	1166	1100 x 2026	1130 x 2015
BK0.010.123	BK0.010.123.01	2466 x 2064	1266	1200 x 2026	1230 x 2015
BK0.020.073	BK0.020.073.01	1466 x 2089	766	700 x 2051	730 x 2040
BK0.020.083	BK0.020.083.01	1666 x 2089	866	800 x 2051	830 x 2040
BK0.020.093	BK0.020.093.01	1866 x 2089	966	900 x 2051	930 x 2040
BK0.020.103	BK0.020.103.01	2066 x 2089	1066	1000 x 2051	1030 x 2040
BK0.020.113	BK0.020.113.01	2266 x 2089	1166	1100 x 2051	1130 x 2040
BK0.020.123	BK0.020.123.01	2466 x 2089	1266	1200 x 2051	1230 x 2040
BK0.030.073	BK0.030.073.01	1466 x 2164	766	700 x 2126	730 x 2115
BK0.030.083	BK0.030.083.01	1666 x 2164	866	800 x 2126	830 x 2115
BK0.030.093	BK0.030.093.01	1866 x 2164	966	900 x 2126	930 x 2115
BK0.030.103	BK0.030.103.01	2066 x 2164	1066	1000 x 2126	1030 x 2115
BK0.030.113	BK0.030.113.01	2266 x 2164	1166	1100 x 2126	1130 x 2115
BK0.030.123	BK0.030.123.01	2466 x 2164	1266	1200 x 2126	1230 x 2115
BK0.040.073	BK0.040.073.01	1466 x 2364	766	700 x 2326	730 x 2315
BK0.040.083	BK0.040.083.01	1666 x 2364	866	800 x 2326	830 x 2315
BK0.040.088	BK0.040.088.01	1766 x 2364	916	850 x 2326	880 x 2315
BK0.040.093	BK0.040.093.01	1866 x 2364	966	900 x 2326	930 x 2315
BK0.040.103	BK0.040.103.01	2066 x 2364	1066	1000 x 2326	1030 x 2315
BK0.040.113	BK0.040.113.01	2266 x 2364	1166	1100 x 2326	1130 x 2315
BK0.040.123	BK0.040.123.01	2466 x 2364	1266	1200 x 2326	1230 x 2315
BK0.050.093	BK0.050.093.01	1866 x 2700	966	900 x 2662	930 x 2651
BK0.050.103	BK0.050.103.01	2066 x 2700	1066	1000 x 2662	1030 x 2651
BK0.050.113	BK0.050.113.01	2266 x 2700	1166	1100 x 2662	1130 x 2651
BK0.050.123	BK0.050.123.01	2466 x 2700	1266	1200 x 2662	1230 x 2651

Each pocket is adjustable in height and width. Feel free to contact our commercial team at any time to discuss customisation possibilities.

Additional items required

assemble your set



	Max. door width	Length	Reference
Suspension profile	1000 mm	236 mm	(2x) 110.828
	1250 mm	1000 mm	110.828.100
	1500 mm	1250 mm	110.828.125
	2000 mm	1500 mm	110.828.150
	3000 mm	2000 mm	110.828.200
Bottom guide track	1000 mm	3000 mm	110.828.300
	1250 mm	1000 mm	510.608.100
	1500 mm	1250 mm	510.608.125
	2000 mm	1500 mm	510.608.150
	3000 mm	2000 mm	510.608.200
	3000 mm	3000 mm	510.608.300

Accessories selection

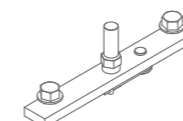

Compact suspension	Standard	Superior
Without softclose	BK0.300*	BK0.800*
With 1 softclose (min. door width = 502 mm)	BK0.300.020*	BK0.800.020*
With 2 softcloses (min. door width = 737 mm)		BK0.800.220
Unislide** - Fittings to be combined with a hoist (max. 60 kg)		Reference
With 1 softclose		BK0.800.08

Technical drawings

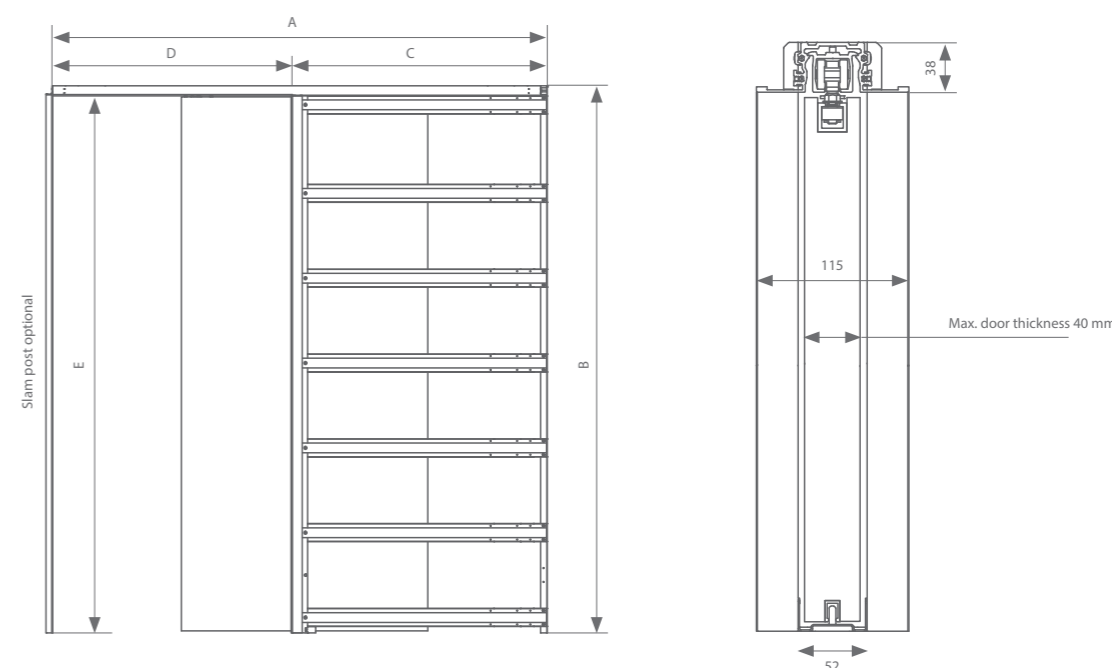

Each fitting set comes with all the rollers or soft-close mechanisms, suspension, guiding systems, and stoppers you need.

A 115-mm-thick wall can be combined with a BK0.398.270 slam post. For more information, see p.60.

*The stopper in the cavity can be replaced with an auto-eject (BK9.660) (see p. 5), where the door can be hidden completely in the wall. A slight push on the side of the door brings it back into a position to be closed. In this case, the side of the cavity must always be 100 mm wider than the clear passage. A pocket that is 100 mm wider should be chosen for this. Then the casing profile and running track are adjusted to the correct door width.

**It is possible to combine a pocket door with a hoist system using a Unislide fitting set. This fitting set contains a soft-close mechanism, zero-play roller, auto-eject, and guiding system.



argenta pocket 80 kg
 single-pocket wall thickness 100/115 mm
 without slam post

Application possibilities

Wall thickness 100 mm: cladding with single plasterboard 12,5 mm (cover fillet required)

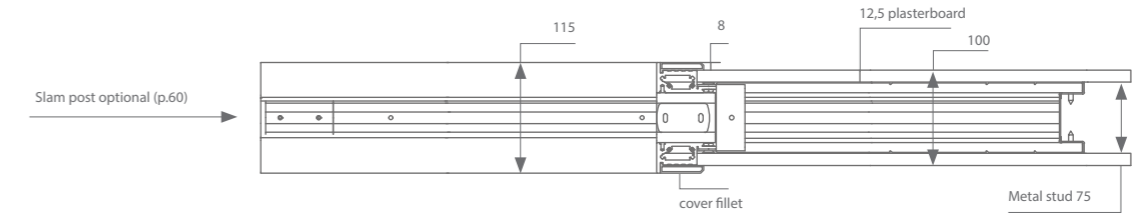

Wall thickness 115 mm: cladding with double plasterboard

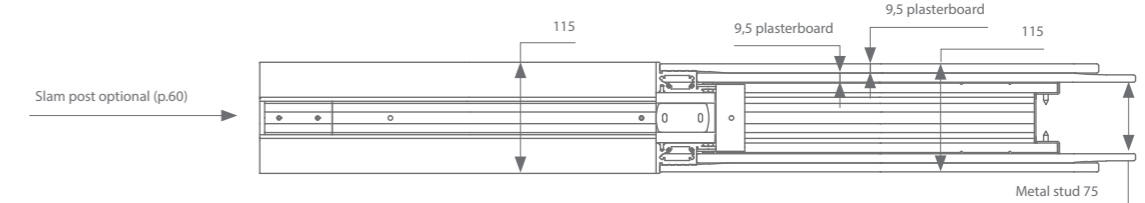

Wall thickness incl. plaster 115 mm

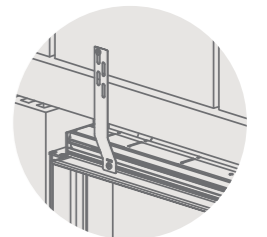
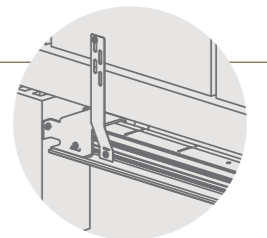
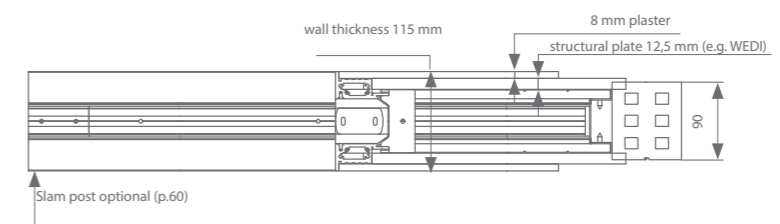

Order set: see previous page.
 Option to be added:
 1 intel mounting set **BK1.010**

double pocket wall thickness 100/115 mm

A bundle contains the following items:

- 1 casing profile
- 2 running tracks
- 2 aluminium lead jambs, left
- 2 aluminium lead jambs, right
- 2 steel wall profiles
- horizontal cross rails
- accessories

Not included:

- Grey brush with a length of 2810 mm: BK0.309.281.000 (1 piece)
- Black brush with a length of 2810 mm: BK0.309.281.020 (1 piece)

Bundles

Brut	Primer	A x B : Recessed installation dimensions	C : Casing Width	D x E : Clear passage	Wooden door panel
BK0.012.073	BK0.012.073.01	2932 x 2064	766	1400 x 2026	730 x 2015
BK0.012.083	BK0.012.083.01	3332 x 2064	866	1600 x 2026	830 x 2015
BK0.012.093	BK0.012.093.01	3732 x 2064	966	1800 x 2026	930 x 2015
BK0.012.103	BK0.012.103.01	4132 x 2064	1066	2000 x 2026	1030 x 2015
BK0.012.113	BK0.012.113.01	4532 x 2064	1166	2200 x 2026	1130 x 2015
BK0.012.123	BK0.012.123.01	4932 x 2064	1266	2400 x 2026	1230 x 2015
BK0.022.073	BK0.022.073.01	2932 x 2089	766	1400 x 2051	730 x 2040
BK0.022.083	BK0.022.083.01	3332 x 2089	866	1600 x 2051	830 x 2040
BK0.022.093	BK0.022.093.01	3732 x 2089	966	1800 x 2051	930 x 2040
BK0.022.103	BK0.022.103.01	4132 x 2089	1066	2000 x 2051	1030 x 2040
BK0.022.113	BK0.022.113.01	4532 x 2089	1166	2200 x 2051	1130 x 2040
BK0.022.123	BK0.022.123.01	4932 x 2089	1266	2400 x 2051	1230 x 2040
BK0.032.073	BK0.032.073.01	2932 x 2164	766	1400 x 2126	730 x 2115
BK0.032.083	BK0.032.083.01	3332 x 2164	866	1600 x 2126	830 x 2115
BK0.032.093	BK0.032.093.01	3732 x 2164	966	1800 x 2126	930 x 2115
BK0.032.103	BK0.032.103.01	4132 x 2164	1066	2000 x 2126	1030 x 2115
BK0.032.113	BK0.032.113.01	4532 x 2164	1166	2200 x 2126	1130 x 2115
BK0.032.123	BK0.032.123.01	4932 x 2164	1266	2400 x 2126	1230 x 2115
BK0.042.073	BK0.042.073.01	2932 x 2364	766	1400 x 2326	730 x 2315
BK0.042.083	BK0.042.083.01	3332 x 2364	866	1600 x 2326	830 x 2315
BK0.042.088	BK0.042.088.01	3532 x 2364	916	1700 x 2326	880 x 2315
BK0.042.093	BK0.042.093.01	3732 x 2364	966	1800 x 2326	930 x 2315
BK0.042.103	BK0.042.103.01	4132 x 2364	1066	2000 x 2326	1030 x 2315
BK0.042.113	BK0.042.113.01	4532 x 2364	1166	2200 x 2326	1130 x 2315
BK0.042.123	BK0.042.123.01	4932 x 2364	1266	2400 x 2326	1230 x 2315
BK0.052.093	BK0.052.093.01	3732 x 2700	966	1800 x 2662	930 x 2651
BK0.052.103	BK0.052.103.01	4132 x 2700	1066	2000 x 2662	1030 x 2651
BK0.052.113	BK0.052.113.01	4532 x 2700	1166	2200 x 2662	1130 x 2651
BK0.052.123	BK0.052.123.01	4932 x 2700	1266	2400 x 2662	1230 x 2651

Each pocket is adjustable in height and width. Feel free to contact our commercial team at any time to discuss customisation possibilities.

Additional items required (2x required)

assemble your set



	Max. door width	Length	Reference
Suspension profile	1000 mm	236 mm	(2x) 110.828
	1250 mm	1000 mm	110.828.100
	1500 mm	1250 mm	110.828.125
	2000 mm	1500 mm	110.828.150
	3000 mm	2000 mm	110.828.200
Bottom guide track	1000 mm	3000 mm	110.828.300
	1250 mm	1000 mm	510.608.100
	1500 mm	1250 mm	510.608.125
	2000 mm	1500 mm	510.608.150
	3000 mm	2000 mm	510.608.200
		3000 mm	510.608.300

Accessories selection (2x required)

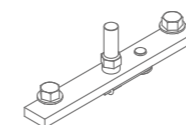

Compact suspension	Standard	Superior
Without softclose	BK0.300*	BK0.800*
With 1 softclose (min. door width = 502 mm)	BK0.300.020*	BK0.800.020*
With 2 softcloses (min. door width = 737 mm)		BK0.800.220
Unislide** - Fittings to be combined with a hoist (max. 60 kg)		Reference
With 1 softclose		BK0.800.08

Technical drawings



Each fitting set comes with all the rollers or soft-close mechanisms, suspension, guiding systems, and stoppers you need.

*The stopper in the cavity can be replaced with an auto-eject (BK9.660) (see p. 5), where the door can be hidden completely in the wall. A slight push on the side of the door brings it back into a position to be closed. In this case, the side of the cavity must always be 100 mm wider than the clear passage. A pocket that is 100 mm wider should be chosen for this. Then the casing profile and running track are adjusted to the correct door width.

**It is possible to combine a pocket door with a hoist system using a Unislide fitting set. This fitting set contains a soft-close mechanism, zero-play roller, auto-eject, and guiding system.



argenta pocket 80 kg
 double pocket wall thickness 100/115 mm

Application possibilities

Wall thickness 100 mm: cladding with single plasterboard 12,5 mm (cover fillet required)

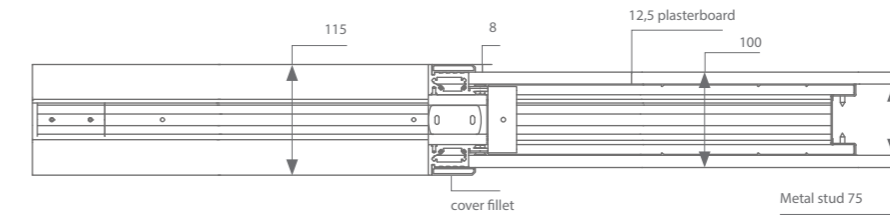

Wall thickness 115 mm: cladding with double plasterboard

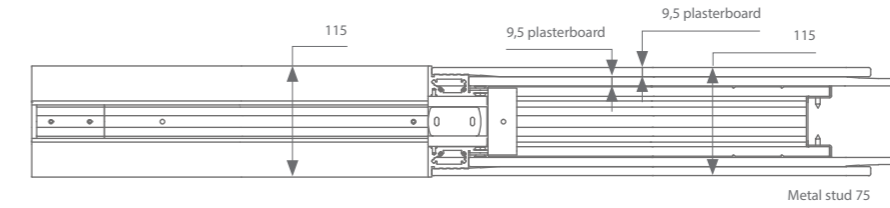

Wall thickness incl. plaster 115 mm

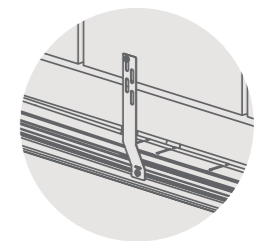
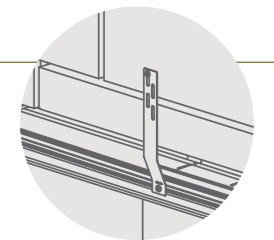
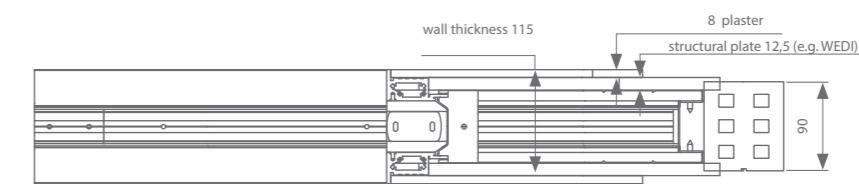

Order set: see previous page.
 Option to be added:
 1 lintel mounting set **BK1.010**

argenta pocket 80 kg

single-pocket wall thickness 125 mm for metal stud 75mm without slam post

A bundle contains the following items:

- 1 casing profile
- 1 running track
- 1 aluminium lead jamb, left
- 1 aluminium lead jamb, right

- 1 steel wall profile
- horizontal cross rails
- accessories

Not included:

- Grey brush with a length of 2810 mm: BK0.309.281.000 (1 piece)
- Black brush with a length of 2810 mm: BK0.309.281.020 (1 piece)

Bundles

Brut	Primer	A x B : Recessed installation dimensions	C : Casing Width	D x E : Clear passage	Wooden door panel
BK0.014.073	BK0.014.073.01	1466 x 2064	766	700 x 2026	730 x 2015
BK0.014.083	BK0.014.083.01	1666 x 2064	866	800 x 2026	830 x 2015
BK0.014.093	BK0.014.093.01	1866 x 2064	966	900 x 2026	930 x 2015
BK0.014.103	BK0.014.103.01	2066 x 2064	1066	1000 x 2026	1030 x 2015
BK0.014.113	BK0.014.113.01	2266 x 2064	1166	1100 x 2026	1130 x 2015
BK0.014.123	BK0.014.123.01	2466 x 2064	1266	1200 x 2026	1230 x 2015
BK0.024.073	BK0.024.073.01	1466 x 2089	766	700 x 2051	730 x 2040
BK0.024.083	BK0.024.083.01	1666 x 2089	866	800 x 2051	830 x 2040
BK0.024.093	BK0.024.093.01	1866 x 2089	966	900 x 2051	930 x 2040
BK0.024.103	BK0.024.103.01	2066 x 2089	1066	1000 x 2051	1030 x 2040
BK0.024.113	BK0.024.113.01	2266 x 2089	1166	1100 x 2051	1130 x 2040
BK0.024.123	BK0.024.123.01	2466 x 2089	1266	1200 x 2051	1230 x 2040
BK0.034.073	BK0.034.073.01	1466 x 2164	766	700 x 2126	730 x 2115
BK0.034.083	BK0.034.083.01	1666 x 2164	866	800 x 2126	830 x 2115
BK0.034.093	BK0.034.093.01	1866 x 2164	966	900 x 2126	930 x 2115
BK0.034.103	BK0.034.103.01	2066 x 2164	1066	1000 x 2126	1030 x 2115
BK0.034.113	BK0.034.113.01	2266 x 2164	1166	1100 x 2126	1130 x 2115
BK0.034.123	BK0.034.123.01	2466 x 2164	1266	1200 x 2126	1230 x 2115
BK0.044.073	BK0.044.073.01	1466 x 2364	766	700 x 2326	730 x 2315
BK0.044.083	BK0.044.083.01	1666 x 2364	866	800 x 2326	830 x 2315
BK0.044.088	BK0.044.088.01	1766 x 2364	916	850 x 2326	880 x 2315
BK0.044.093	BK0.044.093.01	1866 x 2364	966	900 x 2326	930 x 2315
BK0.044.103	BK0.044.103.01	2066 x 2364	1066	1000 x 2326	1030 x 2315
BK0.044.113	BK0.044.113.01	2266 x 2364	1166	1100 x 2326	1130 x 2315
BK0.044.123	BK0.044.123.01	2466 x 2364	1266	1200 x 2326	1230 x 2315
BK0.054.093	BK0.054.093.01	1866 x 2700	966	900 x 2662	930 x 2651
BK0.054.103	BK0.054.103.01	2066 x 2700	1066	1000 x 2662	1030 x 2651
BK0.054.113	BK0.054.113.01	2266 x 2700	1166	1100 x 2662	1130 x 2651
BK0.054.123	BK0.054.123.01	2466 x 2700	1266	1200 x 2662	1230 x 2651

Each pocket is adjustable in height and width. Feel free to contact our commercial team at any time to discuss customisation possibilities.

Additional items required

assemble your set



	Max. door width	Length	Reference
Suspension profile	1000 mm	236 mm	(2x) 110.828
	1250 mm	1000 mm	110.828.100
	1500 mm	1250 mm	110.828.125
	2000 mm	1500 mm	110.828.150
	3000 mm	2000 mm	110.828.200
Bottom guide track	1000 mm	3000 mm	110.828.300
	1250 mm	1000 mm	510.608.100
	1500 mm	1250 mm	510.608.125
	2000 mm	1500 mm	510.608.150
	3000 mm	2000 mm	510.608.200
		3000 mm	510.608.300

Accessories selection

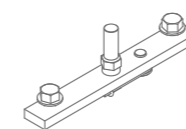

Compact suspension	Standard	Superior
Without softclose	BK0.300*	BK0.800*
With 1 softclose (min. door width = 502 mm)	BK0.300.020*	BK0.800.020*
With 2 softcloses (min. door width = 737 mm)		BK0.800.220
Unislide** - Fittings to be combined with a hoist (max. 60 kg)		Reference
With 1 softclose		BK0.800.08

Technical drawings

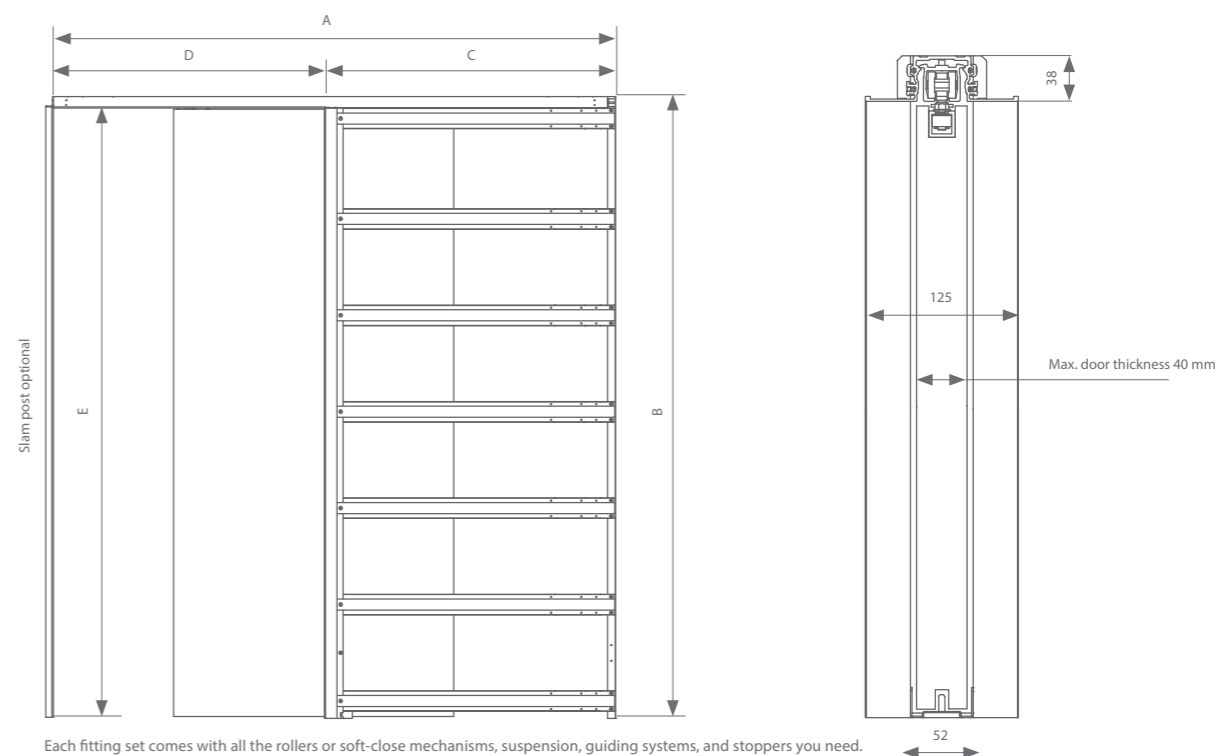

Each fitting set comes with all the rollers or soft-close mechanisms, suspension, guiding systems, and stoppers you need.

A 125-mm-thick wall can be combined with a BK0.395.282 slam post. For more information, see p.60.

*The stopper in the cavity can be replaced with an auto-eject (BK9.660) (see p. 5), where the door can be hidden completely in the wall. A slight push on the side of the door brings it back into a position to be closed. In this case, the side of the cavity must always be 100 mm wider than the clear passage. A pocket that is 100 mm wider should be chosen for this. Then the casing profile and running track are adjusted to the correct door width.

**It is possible to combine a pocket door with a hoist system using a Unislide fitting set. This fitting set contains a soft-close mechanism, zero-play roller, auto-eject, and guiding system.



argenta pocket 80 kg
 single-pocket wall thickness 125 mm
 without slam post

Application possibilities

Wall thickness 125mm: cladding with double plasterboard 12,5 mm

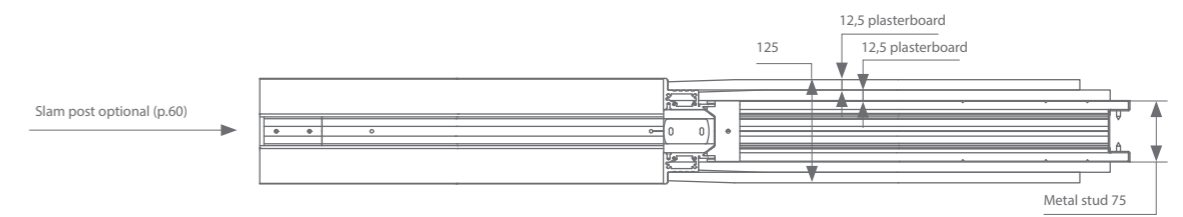

Wall thickness incl. plaster 125 mm

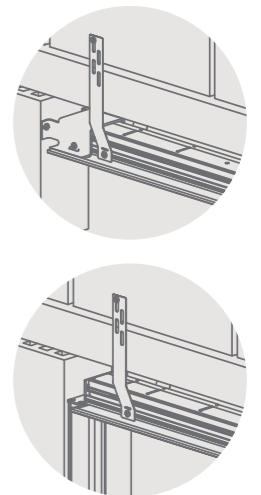
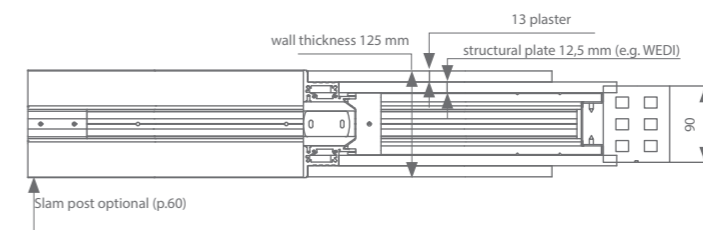

Order set: see previous page.
 Option to be added:
 1 lintel mounting set **BK1.010**

argenta pocket 80 kg
double pocket wall thickness 125 mm

A bundle contains the following items:

- 1 casing profile
- 2 running tracks
- 2 aluminium lead jambs, left
- 2 aluminium lead jambs, right
- 2 steel wall profiles
- horizontal cross rails
- accessories

Not included:

- Grey brush with a length of 2810 mm: BK0.309.281.000 (1 piece)
- Black brush with a length of 2810 mm: BK0.309.281.020 (1 piece)

Bundles

Brut	Primer	A x B : Recessed installation dimensions	C : Casing Width	D x E : Clear passage	Wooden door panel
BK0.015.073	BK0.015.073.01	2932 x 2064	766	1400 x 2026	730 x 2015
BK0.015.083	BK0.015.083.01	3332 x 2064	866	1600 x 2026	830 x 2015
BK0.015.093	BK0.015.093.01	3732 x 2064	966	1800 x 2026	930 x 2015
BK0.015.103	BK0.015.103.01	4132 x 2064	1066	2000 x 2026	1030 x 2015
BK0.015.113	BK0.015.113.01	4532 x 2064	1166	2200 x 2026	1130 x 2015
BK0.015.123	BK0.015.123.01	4932 x 2064	1266	2400 x 2026	1230 x 2015
BK0.025.073	BK0.025.073.01	2932 x 2089	766	1400 x 2051	730 x 2040
BK0.025.083	BK0.025.083.01	3332 x 2089	866	1600 x 2051	830 x 2040
BK0.025.093	BK0.025.093.01	3732 x 2089	966	1800 x 2051	930 x 2040
BK0.025.103	BK0.025.103.01	4132 x 2089	1066	2000 x 2051	1030 x 2040
BK0.025.113	BK0.025.113.01	4532 x 2089	1166	2200 x 2051	1130 x 2040
BK0.025.123	BK0.025.123.01	4932 x 2089	1266	2400 x 2051	1230 x 2040
BK0.035.073	BK0.035.073.01	2932 x 2164	766	1400 x 2126	730 x 2115
BK0.035.083	BK0.035.083.01	3332 x 2164	866	1600 x 2126	830 x 2115
BK0.035.093	BK0.035.093.01	3732 x 2164	966	1800 x 2126	930 x 2115
BK0.035.103	BK0.035.103.01	4132 x 2164	1066	2000 x 2126	1030 x 2115
BK0.035.113	BK0.035.113.01	4532 x 2164	1166	2200 x 2126	1130 x 2115
BK0.035.123	BK0.035.123.01	4932 x 2164	1266	2400 x 2126	1230 x 2115
BK0.045.073	BK0.045.073.01	2932 x 2364	766	1400 x 2326	730 x 2315
BK0.045.083	BK0.045.083.01	3332 x 2364	866	1600 x 2326	830 x 2315
BK0.045.088	BK0.045.088.01	3532 x 2364	916	1700 x 2326	880 x 2315
BK0.045.093	BK0.045.093.01	3732 x 2364	966	1800 x 2326	930 x 2315
BK0.045.103	BK0.045.103.01	4132 x 2364	1066	2000 x 2326	1030 x 2315
BK0.045.113	BK0.045.113.01	4532 x 2364	1166	2200 x 2326	1130 x 2315
BK0.045.123	BK0.045.123.01	4932 x 2364	1266	2400 x 2326	1230 x 2315
BK0.055.093	BK0.055.093.01	3732 x 2700	966	1800 x 2662	930 x 2651
BK0.055.103	BK0.055.103.01	4132 x 2700	1066	2000 x 2662	1030 x 2651
BK0.055.113	BK0.055.113.01	4532 x 2700	1166	2200 x 2662	1130 x 2651
BK0.055.123	BK0.055.123.01	4932 x 2700	1266	2400 x 2662	1230 x 2651

Each pocket is adjustable in height and width. Feel free to contact our commercial team at any time to discuss customisation possibilities.

Additional items required (2x required)

assemble your set 

	Max. door width	Length	Reference
Suspension profile	1000 mm	236 mm	(2x) 110.828
	1250 mm	1000 mm	110.828.100
	1500 mm	1250 mm	110.828.125
	2000 mm	1500 mm	110.828.150
	3000 mm	2000 mm	110.828.200
Bottom guide track	1000 mm	3000 mm	110.828.300
	1250 mm	1000 mm	510.608.100
	1500 mm	1250 mm	510.608.125
	2000 mm	1500 mm	510.608.150
	3000 mm	2000 mm	510.608.200
		3000 mm	510.608.300

Accessories selection (2x required)

Compact suspension	Standard	Superior
Without softclose	BK0.300*	BK0.800*
With 1 softclose (min. door width = 502 mm)	BK0.300.020*	BK0.800.020*
With 2 softcloses (min. door width = 737 mm)		BK0.800.220
Unislide** - Fittings to be combined with a hoist (max. 60 kg)		Reference
With 1 softclose		BK0.800.08

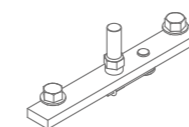

Technical drawings

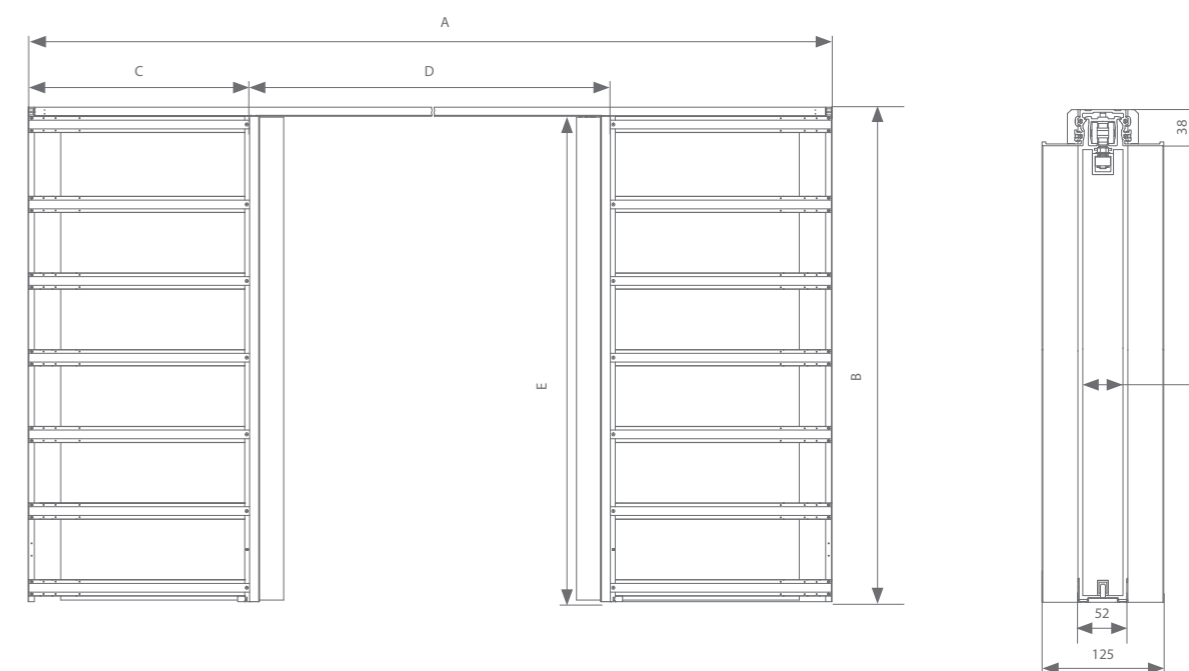

Each fitting set comes with all the rollers or soft-close mechanisms, suspension, guiding systems, and stoppers you need.

*The stopper in the cavity can be replaced with an auto-eject (BK9.660) (see p. 5), where the door can be hidden completely in the wall. A slight push on the side of the door brings it back into a position to be closed. In this case, the side of the cavity must always be 100 mm wider than the clear passage. A pocket that is 100 mm wider should be chosen for this. Then the casing profile and running track are adjusted to the correct door width.

**It is possible to combine a pocket door with a hoist system using a Unislide fitting set. This fitting set contains a soft-close mechanism, zero-play roller, auto-eject, and guiding system.



argenta pocket 80 kg
 double-pocket wall thickness 125 mm

Application possibilities

Wall thickness 125mm: cladding with double plasterboard 12,5 mm

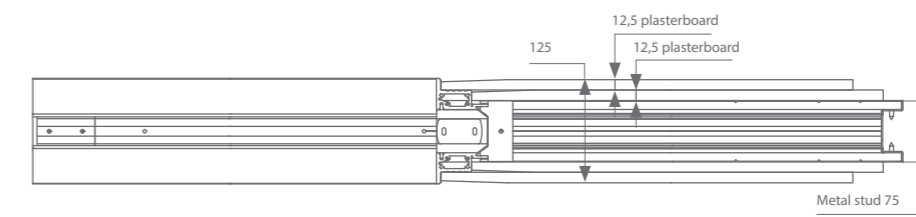

Wall thickness incl. plaster 125 mm

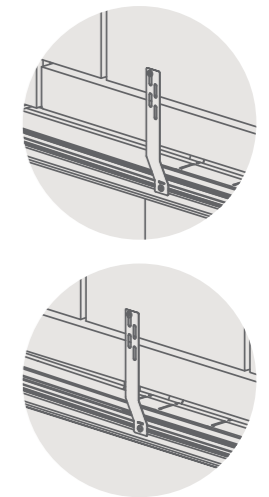
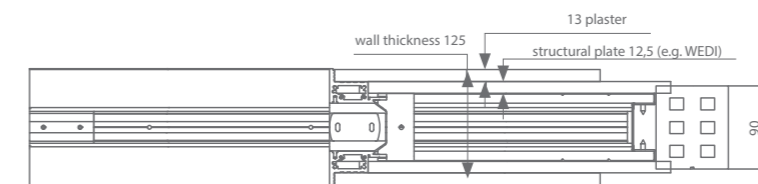

Order set: see previous page.
 Option to be added:
 1 lintel mounting set **BK1.010**

single-pocket wall thickness 160 mm without slam post

A bundle contains the following items:

- 1 casing profile
- 1 running track
- 1 aluminium lead jamb, left
- 1 aluminium lead jamb, right
- 1 steel wall profile
- horizontal cross rails
- accessories

Not included:

- Grey brush with a length of 2810 mm: BK0.309.281.000 (1 piece)
- Black brush with a length of 2810 mm: BK0.309.281.020 (1 piece)

Bundles

Brut	Primer	A x B : Recessed installation dimensions	C : Casing Width	D x E : Clear passage	Wooden door panel
BK0.011.073	BK0.011.073.01	1466 x 2064	766	700 x 2026	730 x 2015
BK0.011.083	BK0.011.083.01	1666 x 2064	866	800 x 2026	830 x 2015
BK0.011.093	BK0.011.093.01	1866 x 2064	966	900 x 2026	930 x 2015
BK0.011.103	BK0.011.103.01	2066 x 2064	1066	1000 x 2026	1030 x 2015
BK0.011.113	BK0.011.113.01	2266 x 2064	1166	1100 x 2026	1130 x 2015
BK0.011.123	BK0.011.123.01	2466 x 2064	1266	1200 x 2026	1230 x 2015
BK0.021.073	BK0.021.073.01	1466 x 2089	766	700 x 2051	730 x 2040
BK0.021.083	BK0.021.083.01	1666 x 2089	866	800 x 2051	830 x 2040
BK0.021.093	BK0.021.093.01	1866 x 2089	966	900 x 2051	930 x 2040
BK0.021.103	BK0.021.103.01	2066 x 2089	1066	1000 x 2051	1030 x 2040
BK0.021.113	BK0.021.113.01	2266 x 2089	1166	1100 x 2051	1130 x 2040
BK0.021.123	BK0.021.123.01	2466 x 2089	1266	1200 x 2051	1230 x 2040
BK0.031.073	BK0.031.073.01	1466 x 2164	766	700 x 2126	730 x 2115
BK0.031.083	BK0.031.083.01	1666 x 2164	866	800 x 2126	830 x 2115
BK0.031.093	BK0.031.093.01	1866 x 2164	966	900 x 2126	930 x 2115
BK0.031.103	BK0.031.103.01	2066 x 2164	1066	1000 x 2126	1030 x 2115
BK0.031.113	BK0.031.113.01	2266 x 2164	1166	1100 x 2126	1130 x 2115
BK0.031.123	BK0.031.123.01	2466 x 2164	1266	1200 x 2126	1230 x 2115
BK0.041.073	BK0.041.073.01	1466 x 2364	766	700 x 2326	730 x 2315
BK0.041.083	BK0.041.083.01	1666 x 2364	866	800 x 2326	830 x 2315
BK0.041.088	BK0.041.088.01	1766 x 2364	916	850 x 2326	880 x 2315
BK0.041.093	BK0.041.093.01	1866 x 2364	966	900 x 2326	930 x 2315
BK0.041.103	BK0.041.103.01	2066 x 2364	1066	1000 x 2326	1030 x 2315
BK0.041.113	BK0.041.113.01	2266 x 2364	1166	1100 x 2326	1130 x 2315
BK0.041.123	BK0.041.123.01	2466 x 2364	1266	1200 x 2326	1230 x 2315
BK0.051.093	BK0.051.093.01	1866 x 2700	966	900 x 2662	930 x 2651
BK0.051.103	BK0.051.103.01	2066 x 2700	1066	1000 x 2662	1030 x 2651
BK0.051.113	BK0.051.113.01	2266 x 2700	1166	1100 x 2662	1130 x 2651
BK0.051.123	BK0.051.123.01	2466 x 2700	1266	1200 x 2662	1230 x 2651

Each pocket is adjustable in height and width. Feel free to contact our commercial team at any time to discuss customisation possibilities.

Additional items required

assemble your set



	Max. door width	Length	Reference
Suspension profile	1000 mm	236 mm	(2x) 110.828
	1250 mm	1000 mm	110.828.100
	1500 mm	1250 mm	110.828.125
	2000 mm	1500 mm	110.828.150
	3000 mm	2000 mm	110.828.200
Bottom guide track	1000 mm	3000 mm	110.828.300
	1000 mm	1000 mm	510.608.100
	1250 mm	1250 mm	510.608.125
	1500 mm	1500 mm	510.608.150
	2000 mm	2000 mm	510.608.200
	3000 mm	3000 mm	510.608.300

Accessories selection

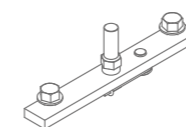

Compact suspension	Standard	Superior
Without softclose	BK0.301*	BK0.801*
With 1 softclose (min. door width = 502 mm)	BK0.301.020*	BK0.801.020*
With 2 softcloses (min. door width = 737 mm)		BK0.801.220
Unislide** - Fittings to be combined with a hoist (max. 60 kg)		Reference
With 1 softclose		BK0.801.08

Technical drawings

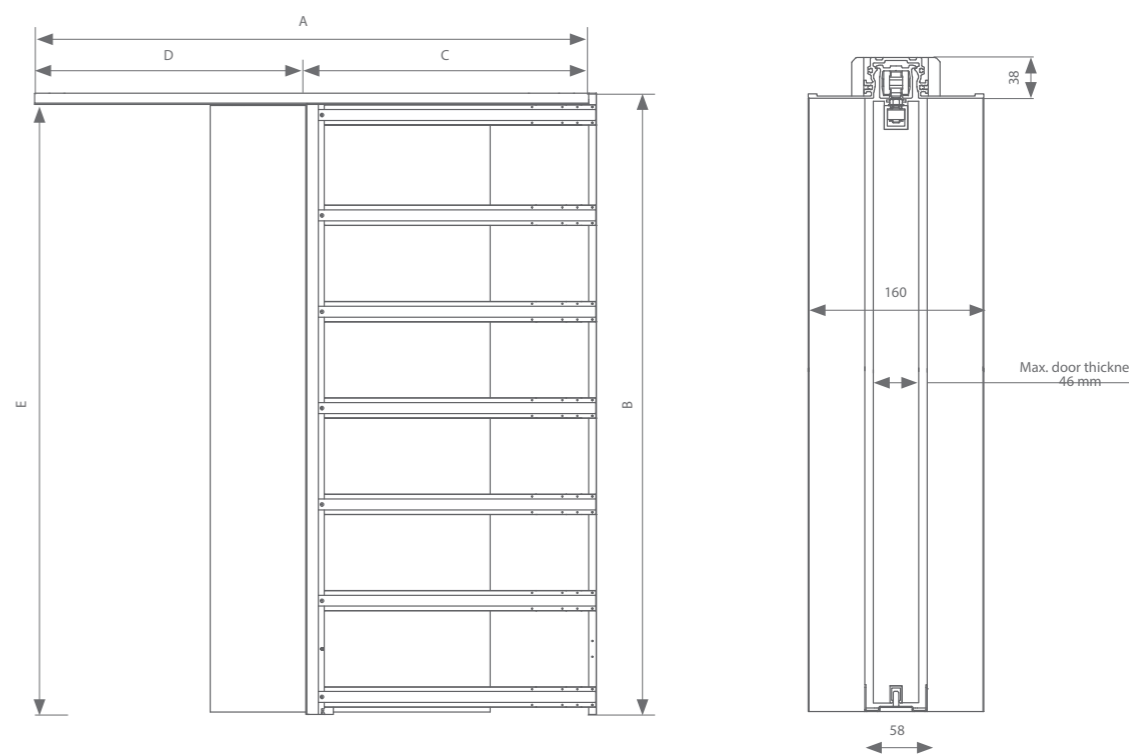

Each fitting set comes with all the rollers or soft-close mechanisms, suspension, guiding systems, and stoppers you need.

*The stopper in the cavity can be replaced with an auto-eject (BK9.660) (see p. 5), where the door can be hidden completely in the wall. A slight push on the side of the door brings it back into a position to be closed. In this case, the side of the cavity must always be 100 mm wider than the clear passage. A pocket that is 100 mm wider should be chosen for this. Then the casing profile and running track are adjusted to the correct door width.

**It is possible to combine a pocket door with a hoist system using a Unislide fitting set. This fitting set contains a soft-close mechanism, zero-play roller, auto-eject, and guiding system.



argenta pocket 80 kg
single-pocket wall thickness 160 mm
 without slam post

Application possibilities

Wall thickness 160 mm: cladding with Thermogyp X 9.5/20 board + 9,5 mm plasterboard placed in offset (or 9.5/30 board)

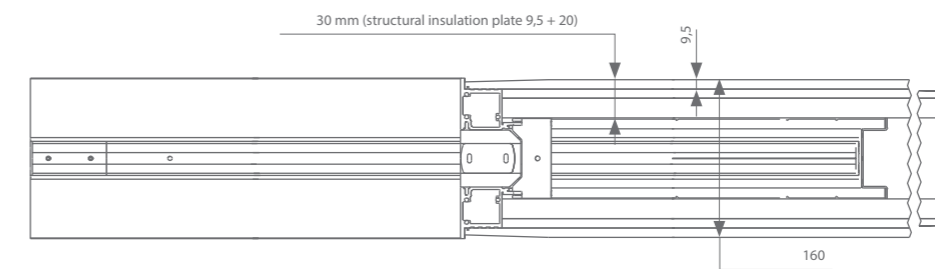

Wall thickness incl. plaster 160 mm

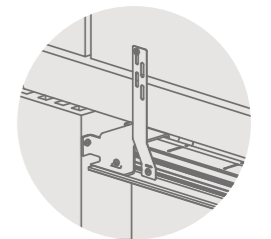
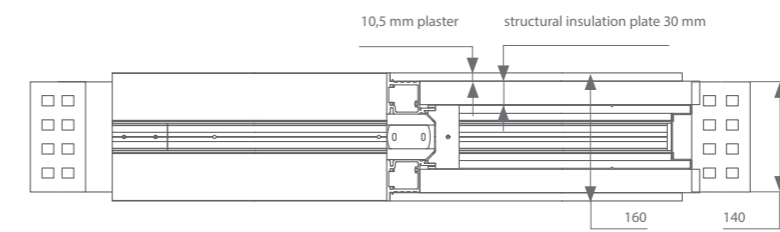

Order set: see previous page.
 Option to be added:
 1 lintel mounting set **BK1.011**

argenta pocket 80 kg
double pocket wall thickness 160 mm

A bundle contains the following items:

- 1 casing profile
- 2 running tracks
- 2 aluminium lead jambs, left
- 2 aluminium lead jambs, right
- 2 steel wall profiles
- horizontal cross rails
- accessories

Not included:

- Grey brush with a length of 2810 mm: BK0.309.281.000 (1 piece)
- Black brush with a length of 2810 mm: BK0.309.281.020 (1 piece)

Bundles

	A x B : Recessed installation dimensions	C : Casing Width	D x E : Clear passage	Wooden door panel
BK0.013.073	2932 x 2064	766	1400 x 2026	730 x 2015
BK0.013.083	3332 x 2064	866	1600 x 2026	830 x 2015
BK0.013.093	3732 x 2064	966	1800 x 2026	930 x 2015
BK0.013.103	4132 x 2064	1066	2000 x 2026	1030 x 2015
BK0.013.113	4532 x 2064	1166	2200 x 2026	1130 x 2015
BK0.013.123	4932 x 2064	1266	2400 x 2026	1230 x 2015
BK0.023.073	2932 x 2089	766	1400 x 2051	730 x 2040
BK0.023.083	3332 x 2089	866	1600 x 2051	830 x 2040
BK0.023.093	3732 x 2089	966	1800 x 2051	930 x 2040
BK0.023.103	4132 x 2089	1066	2000 x 2051	1030 x 2040
BK0.023.113	4532 x 2089	1166	2200 x 2051	1130 x 2040
BK0.023.123	4932 x 2089	1266	2400 x 2051	1230 x 2040
BK0.033.073	2932 x 2164	766	1400 x 2126	730 x 2115
BK0.033.083	3332 x 2164	866	1600 x 2126	830 x 2115
BK0.033.093	3732 x 2164	966	1800 x 2126	930 x 2115
BK0.033.103	4132 x 2164	1066	2000 x 2126	1030 x 2115
BK0.033.113	4532 x 2164	1166	2200 x 2126	1130 x 2115
BK0.033.123	4932 x 2164	1266	2400 x 2126	1230 x 2115
BK0.043.073	2932 x 2364	766	1400 x 2326	730 x 2315
BK0.043.083	3332 x 2364	866	1600 x 2326	830 x 2315
BK0.043.088	3532 x 2364	916	1700 x 2326	880 x 2315
BK0.043.093	3732 x 2364	966	1800 x 2326	930 x 2315
BK0.043.103	4132 x 2364	1066	2000 x 2326	1030 x 2315
BK0.043.113	4532 x 2364	1166	2200 x 2326	1130 x 2315
BK0.043.123	4932 x 2364	1266	2400 x 2326	1230 x 2315
BK0.053.093	3732 x 2700	966	1800 x 2662	930 x 2651
BK0.053.103	4132 x 2700	1066	2000 x 2662	1030 x 2651
BK0.053.113	4532 x 2700	1166	2200 x 2662	1130 x 2651
BK0.053.123	4932 x 2700	1266	2400 x 2662	1230 x 2651

Each pocket is adjustable in height and width. Feel free to contact our commercial team at any time to discuss customisation possibilities.

Additional items required (2x required)

assemble your set 

	Max. door width	Length	Reference
Suspension profile	1000 mm	236 mm	(2x) 110.828
	1250 mm	1000 mm	110.828.100
	1500 mm	1250 mm	110.828.125
	2000 mm	1500 mm	110.828.150
	3000 mm	2000 mm	110.828.200
Bottom guide track	1000 mm	3000 mm	110.828.300
	1250 mm	1000 mm	510.608.100
	1500 mm	1250 mm	510.608.125
	2000 mm	1500 mm	510.608.150
	3000 mm	2000 mm	510.608.200
		3000 mm	510.608.300

Accessories selection (2x required)

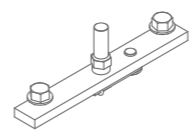
	Compact suspension	Standard	Superior
	Without softclose	BK0.300*	BK0.800*
	With 1 softclose (min. door width = 502 mm)	BK0.300.020*	BK0.800.020*
	With 2 softcloses (min. door width = 737 mm)		BK0.800.220
	Unislide** - Fittings to be combined with a hoist (max. 60 kg)		Reference
	With 1 softclose		BK0.801.08

Technical drawings

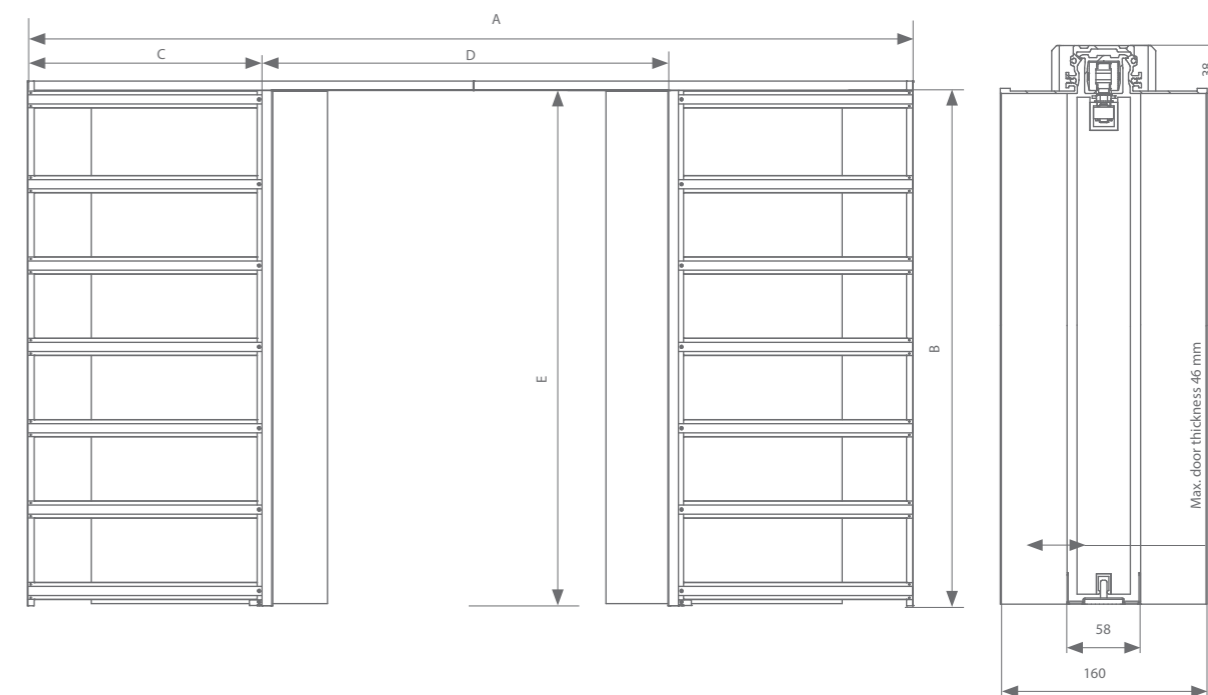

Each fitting set comes with all the rollers or soft-close mechanisms, suspension, guiding systems, and stoppers you need.

*The stopper in the cavity can be replaced with an auto-eject (BK9.660) (see p. 5), where the door can be hidden completely in the wall. A slight push on the side of the door brings it back into a position to be closed. In this case, the side of the cavity must always be 100 mm wider than the clear passage. A pocket that is 100 mm wider should be chosen for this. Then the casing profile and running track are adjusted to the correct door width.

**It is possible to combine a pocket door with a hoist system using a Unislide fitting set. This fitting set contains a soft-close mechanism, zero-play roller, auto-eject, and guiding system.



argenta pocket 80 kg
 double-pocket wall thickness 160 mm

Application possibilities

Wall thickness 160 mm: cladding with Thermogyp X 9,5/20 board + 9,5 mm plasterboard placed in offset (or 9,5/30 board)

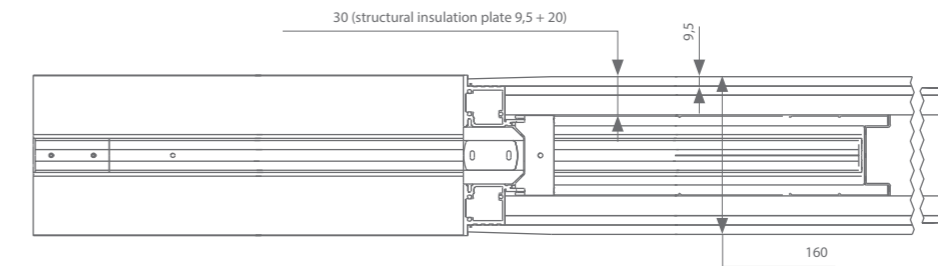

Wall thickness incl. plaster 160 mm

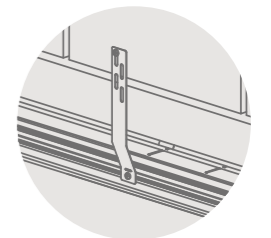
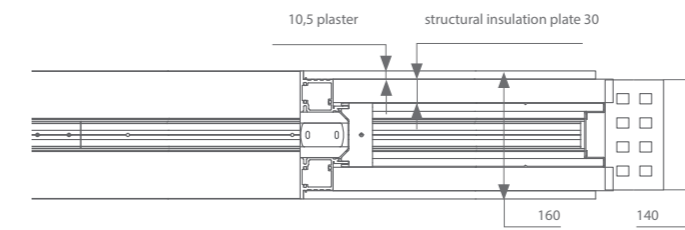

Order set: see previous page.
 Option to be added:
 1 lintel mounting set **BK1.011**

Technical drawings

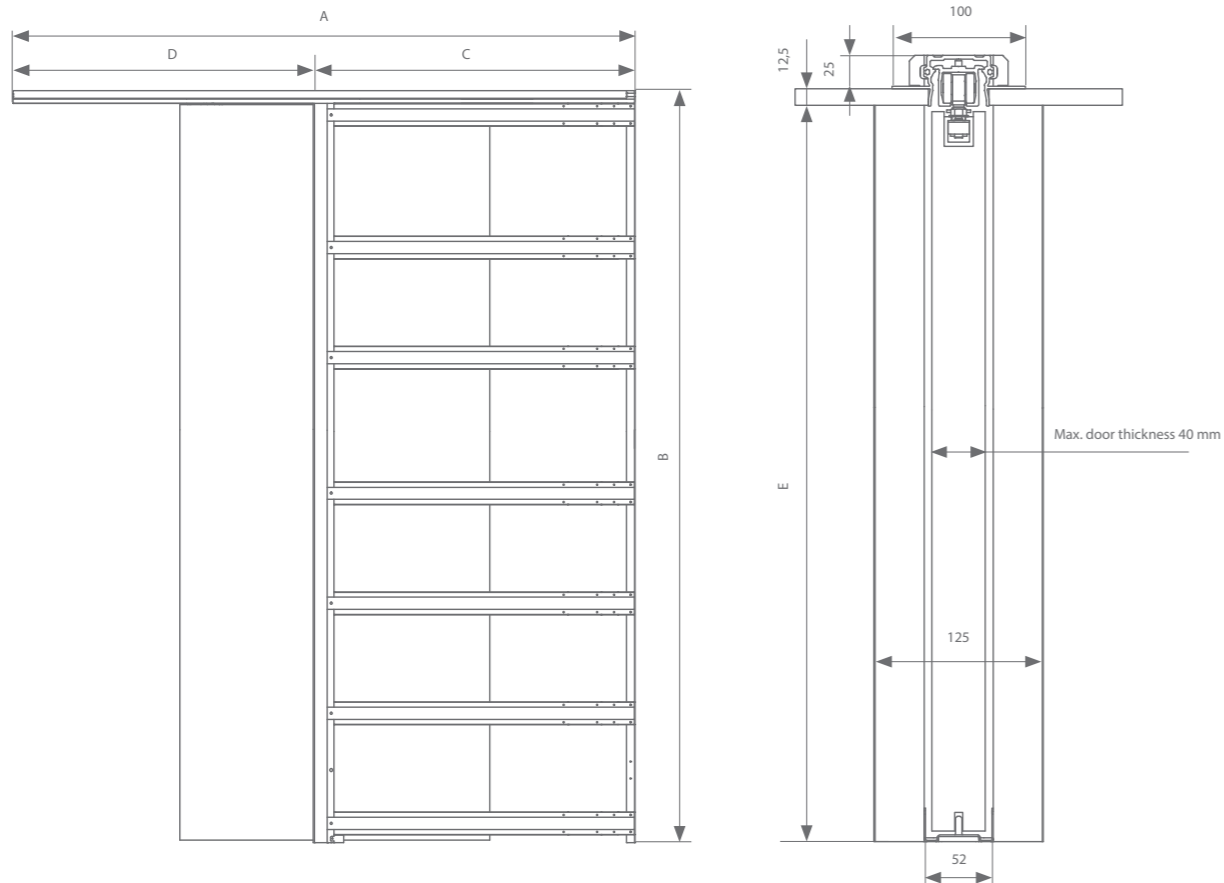

Wall thickness 125mm: cladding with double plasterboard 12,5 mm

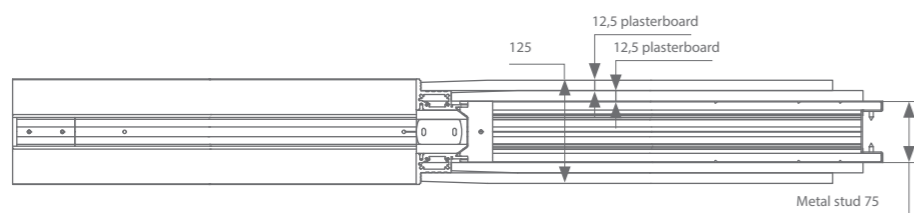

A bundle contains the following items:

- 1 casing profile
- 1 running track
- 1 aluminium lead jamb, left
- 1 aluminium lead jamb, right
- 1 steel wall profile
- horizontal cross rails
- accessories

Not included:

- Grey brush with a length of 2810 mm: BK0.309.281.000 (1 piece)
- Black brush with a length of 2810 mm: BK0.309.281.020 (1 piece)

Bundles

Brut	Primer	A x B : Recessed installation dimensions	C : Casing Width	D x E : Clear passage	Wooden door panel
BK0.160.093	BK0.160.093.01	1866 x 2838	966	900 x 2800	930 x 2788
BK0.160.103	BK0.160.103.01	2066 x 2838	1066	1000 x 2800	1030 x 2788
BK0.160.113	BK0.160.113.01	2266 x 2838	1166	1100 x 2800	1130 x 2788
BK0.160.123	BK0.160.123.01	2466 x 2838	1266	1200 x 2800	1230 x 2788

Additional items required

	Max. door width	Length	Reference
Suspension profile		236 mm	(2x) 110.828
	1000 mm	1000 mm	110.828.100
	1250 mm	1250 mm	110.828.125
	1500 mm	1500 mm	110.828.150
	2000 mm	2000 mm	110.828.200
Bottom guide track	3000 mm	3000 mm	110.828.300
	1000 mm	1000 mm	510.608.100
	1250 mm	1250 mm	510.608.125
	1500 mm	1500 mm	510.608.150
	2000 mm	2000 mm	510.608.200
	3000 mm	3000 mm	510.608.300

Accessories selection

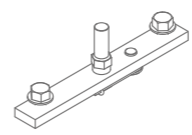
	Compact suspension	Standard	Superior
	Without softclose	BK0.300*	BK0.800*
	With 1 softclose (min. door width = 502 mm)	BK0.300.020*	BK0.800.020*
	With 2 softcloses (min. door width = 737 mm)		BK0.800.220
Unislide** - Fittings to be combined with a hoist (max. 60 kg)			Reference
	With 1 softclose		BK0.800.08

Each pocket is adjustable in height and width. Feel free to contact our commercial team at any time to discuss customisation possibilities. Each fitting set comes with all the rollers or soft-close mechanisms, suspension, guiding systems, and stoppers you need. A 125-mm-thick wall can be combined with a BK0.395.282 slam post. For more information, see p.60.
 *The stopper in the cavity can be replaced with an auto-eject (BK9.660) (see p. 5), where the door can be hidden completely in the wall. A slight push on the side of the door brings it back into a position to be closed. In this case, the side of the cavity must always be 100 mm wider than the clear passage. A pocket that is 100 mm wider should be chosen for this. Then the casing profile and running track are adjusted to the correct door width.
 **It is possible to combine a pocket door with a hoist system using a Unislide fitting set. This fitting set contains a soft-close mechanism, zero-play roller, auto-eject, and guiding system.

Technical drawings

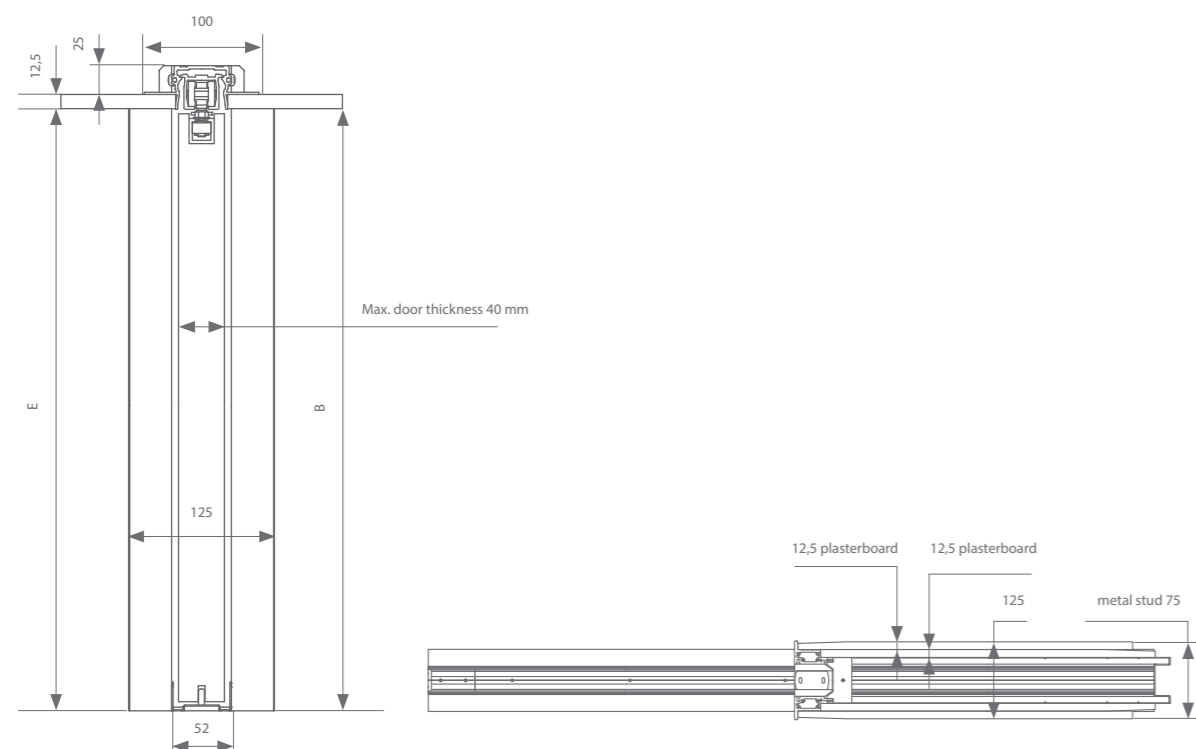
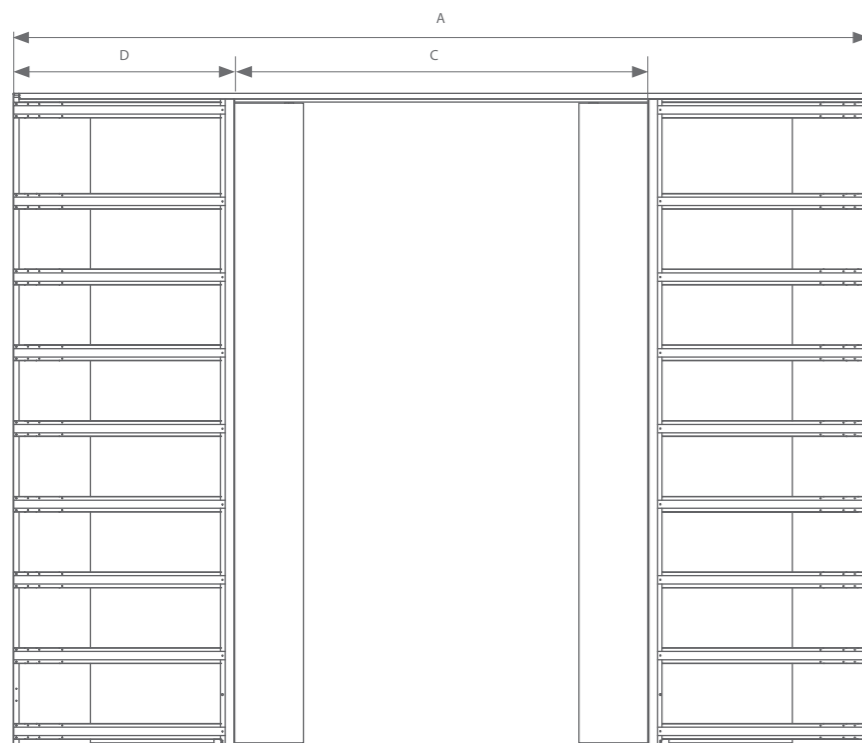

A bundle contains the following items:

- 1 casing profile
- 2 running tracks
- 2 aluminium lead jambs, left
- 2 aluminium lead jambs, right
- 2 steel wall profiles
- horizontal cross rails
- accessories

Not included:

- Grey brush with a length of 2810 mm: BK0.309.281.000 (1 piece)
- Black brush with a length of 2810 mm: BK0.309.281.020 (1 piece)

Bundle

Brut	Primer	A x B : Recessed installation dimensions	C : Casing Width	D x E : Clear passage	Wooden door panel
BK0.165.093	BK0.165.093.01	3732 x 2838	966	1800 x 2800	930 x 2788
BK0.165.103	BK0.165.103.01	4132 x 2838	1066	2000 x 2800	1030 x 2788
BK0.165.113	BK0.165.113.01	4532 x 2838	1166	2200 x 2800	1130 x 2788
BK0.165.123	BK0.165.123.01	4932 x 2838	1266	2400 x 2800	1230 x 2788

Additional items required (2x required)

	Max. door width	Length	Reference
Suspension profile	1000 mm	236 mm	(2x) 110.828
	1250 mm	1000 mm	110.828.100
	1500 mm	1250 mm	110.828.125
	2000 mm	1500 mm	110.828.150
	3000 mm	2000 mm	110.828.200
Bottom guide track	1000 mm	3000 mm	110.828.300
	1250 mm	1000 mm	510.608.100
	1500 mm	1250 mm	510.608.125
	2000 mm	1500 mm	510.608.150
	3000 mm	2000 mm	510.608.200

Accessories selection (2x required)

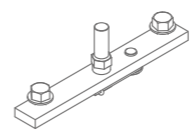
	Compact suspension	Standard	Superior
	Without softclose	BK0.300*	BK0.800*
	With 1 softclose (min. door width = 502 mm)	BK0.300.020*	BK0.800.020*
	With 2 softcloses (min. door width = 737 mm)		BK0.800.220
Unislide** - Fittings to be combined with a hoist (max. 60 kg)			Reference
	With 1 softclose		BK0.800.08

Each pocket is adjustable in height and width. Feel free to contact our commercial team at any time to discuss customisation possibilities. Each fitting set comes with all the rollers or soft-close mechanisms, suspension, guiding systems, and stoppers you need. A 125-mm-thick wall can be combined with a BK0.395.282 slam post. For more information, see p.60.
*The stopper in the cavity can be replaced with an auto-eject (BK9.660) (see p. 5), where the door can be hidden completely in the wall. A slight push on the side of the door brings it back into a position to be closed. In this case, the side of the cavity must always be 100 mm wider than the clear passage. A pocket that is 100 mm wider should be chosen for this. Then the casing profile and running track are adjusted to the correct door width.
**It is possible to combine a pocket door with a hoist system using a Unislide fitting set. This fitting set contains a soft-close mechanism, zero-play roller, auto-eject, and guiding system.



argenta
POCKET 120 KG
FOR WOODEN DOORS

All door heights fit into a dry lining wall with a thickness of 160 mm with a maximum door weight of 120 kg. There is also a solution for ceiling-high doors. All standard dimensions have already been prepared in a standard bundle of profiles. You then only have to make the choice for the fitting and possibly an auto-eject.

A bundle contains the following items:

- 1 casing profile
- 1 running track
- 1 aluminium lead jamb, left
- 1 aluminium lead jamb, right
- 1 steel wall profile
- horizontal cross rails
- accessories

Not included:

- Grey brush with a length of 2810 mm: BK0.309.281.000 (1 piece)
- Black brush with a length of 2810 mm: BK0.309.281.020 (1 piece)

Bundles

Brut	Primer	A x B : Recessed installation dimensions	C : Casing Width	D x E : Clear passage	Wooden door panel
BM0.011.093	BM0.011.093.01	1866 x 2074	966	900 x 2026	930 x 2015
BM0.011.103	BM0.011.103.01	2066 x 2074	1066	1000 x 2026	1030 x 2015
BM0.011.113	BM0.011.113.01	2266 x 2074	1166	1100 x 2026	1130 x 2015
BM0.011.123	BM0.011.123.01	2466 x 2074	1266	1200 x 2026	1230 x 2015
BM0.031.093	BM0.031.093.01	1866 x 2174	966	900 x 2126	930 x 2115
BM0.031.103	BM0.031.103.01	2066 x 2174	1066	1000 x 2126	1030 x 2115
BM0.031.113	BM0.031.113.01	2266 x 2174	1166	1100 x 2126	1130 x 2115
BM0.031.123	BM0.031.123.01	2466 x 2174	1266	1200 x 2126	1230 x 2115
BM0.051.093	BM0.051.093.01	1866 x 2710	966	900 x 2662	930 x 2651
BM0.051.103	BM0.051.103.01	2066 x 2710	1066	1000 x 2662	1030 x 2651
BM0.051.113	BM0.051.113.01	2266 x 2710	1166	1100 x 2662	1130 x 2651
BM0.051.123	BM0.051.123.01	2466 x 2710	1266	1200 x 2662	1230 x 2651

Additional items required

	Max. door width	Length	Reference
Suspension profile		236 mm	(2x) 110.828
	1000 mm	1000 mm	110.828.100
	1250 mm	1250 mm	110.828.125
	1500 mm	1500 mm	110.828.150
	2000 mm	2000 mm	110.828.200
Bottom guide track	3000 mm	3000 mm	110.828.300
	1000 mm	1000 mm	510.608.100
	1250 mm	1250 mm	510.608.125
	1500 mm	1500 mm	510.608.150
	2000 mm	2000 mm	510.608.200
	3000 mm	3000 mm	510.608.300

Each pocket is adjustable in height and width. Feel free to contact our commercial team at any time to discuss customisation possibilities.

Accessories selection

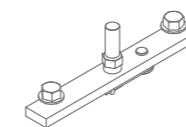

Compact suspension	Superior
Without softclose	BM0.801*
With 1 softclose (min. door width = 562 mm)	BM0.801.020*
With 2 softcloses (min. door width = 807 mm)	BM0.801.220
Unislide** - Fittings to be combined with a hoist (max. 90 kg)	Reference
With 1 softclose	BM0.801.08

Technical drawings

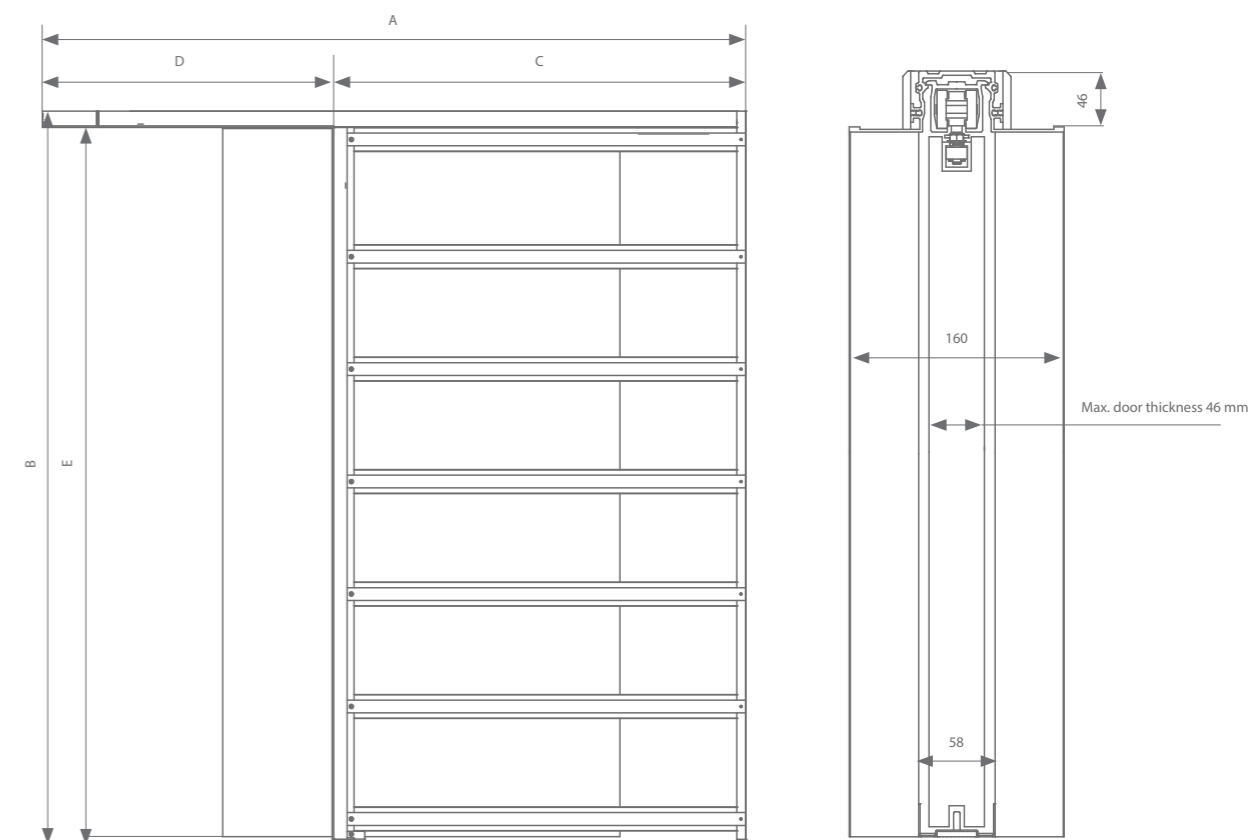

Each fitting set comes with all the rollers or soft-close mechanisms, suspension, guiding systems, and stoppers you need.

*The stopper in the cavity can be replaced with an auto-eject (BK9.660) (see p. 5), where the door can be hidden completely in the wall. A slight push on the side of the door brings it back into a position to be closed. In this case, the side of the cavity must always be 100 mm wider than the clear passage. A pocket that is 100 mm wider should be chosen for this. Then the casing profile and running track are adjusted to the correct door width.

**It is possible to combine a pocket door with a hoist system using a Unislide fitting set. This fitting set contains a soft-close mechanism, zero-play roller, auto-eject, and guiding system.



argenta pocket 120 kg
 single-pocket wall thickness 160 mm
 without slam post

Application possibilities

Wall thickness 160mm: cladding with Thermogyp X 9.5/20 board + 9,5mm plasterboard placed in offset (or 9.5/30 board)

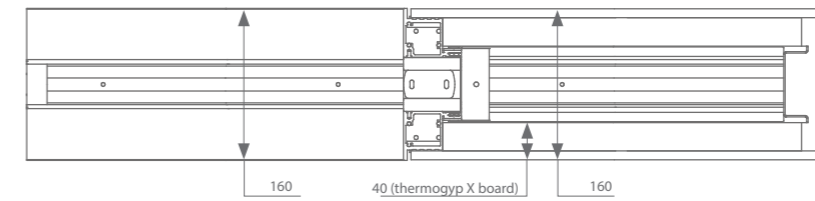

Wall thickness incl. plaster 160 mm

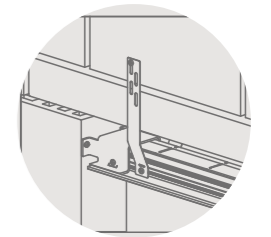
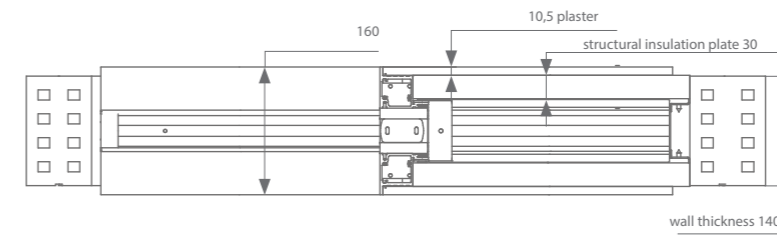

Order set: see previous page.
 Option to be added:
 1 lintel mounting set **BM1.011**

Technical drawings

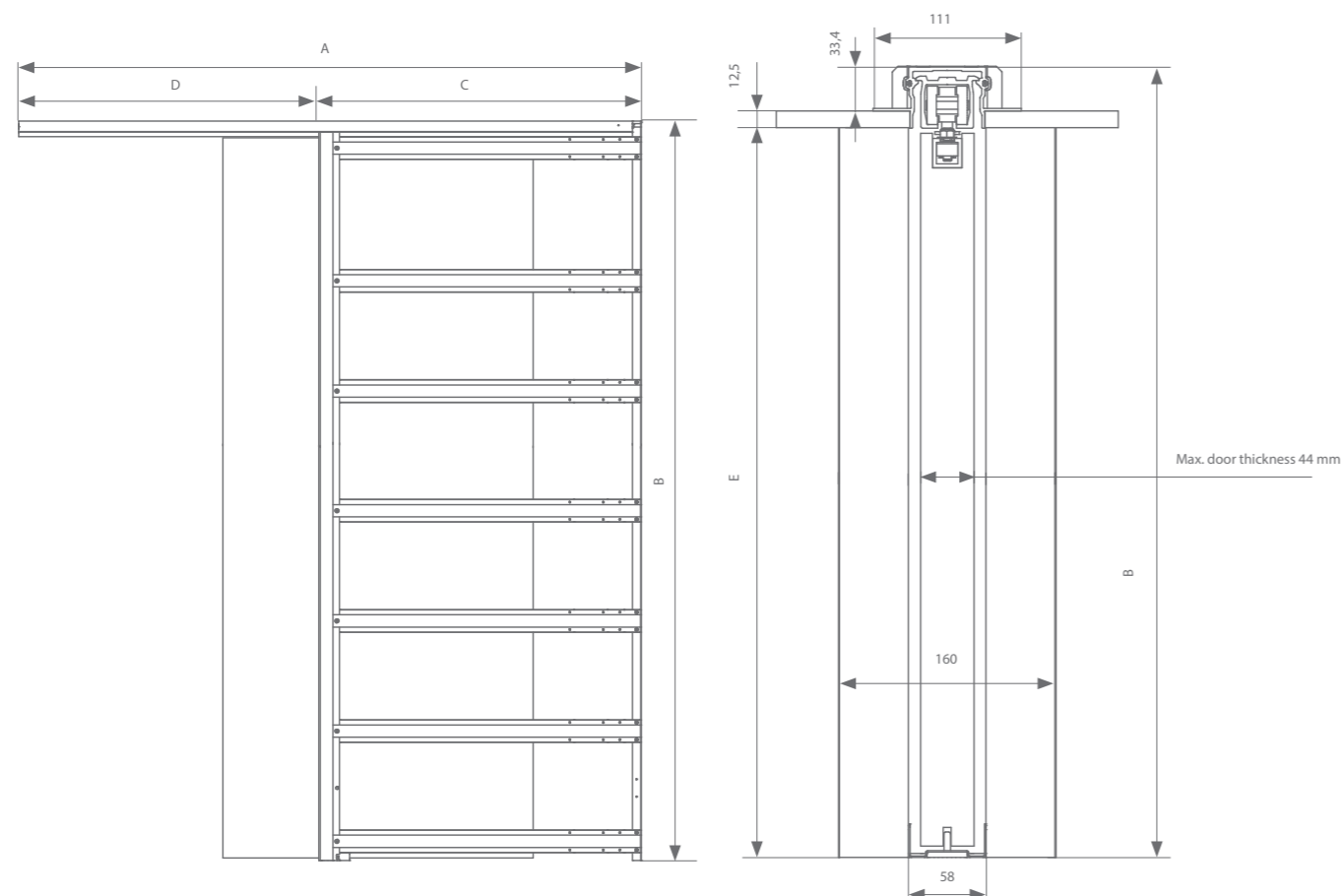

A bundle contains the following items:

- 1 casing profile
- 1 running track
- 1 aluminium lead jamb, left
- 1 aluminium lead jamb, right
- 1 steel wall profile
- horizontal cross rails
- accessories

Not included:

- Grey brush with a length of 2810 mm: BK0.309.281.000 (1 piece)
- Black brush with a length of 2810 mm: BK0.309.281.020 (1 piece)

Bundles

Brut	Primer	A x B : Recessed installation dimensions	C : Casing Width	D x E : Clear passage	Wooden door panel
BM0.160.093	BM0.160.093.01	1866 x 2847	966	900 x 2800	930 x 2788
BM0.160.103	BM0.160.103.01	2066 x 2847	1066	1000 x 2800	1030 x 2788
BM0.160.113	BM0.160.113.01	2266 x 2847	1166	1100 x 2800	1130 x 2788
BM0.160.123	BM0.160.123.01	2466 x 2847	1266	1200 x 2800	1230 x 2788

Additional items required

	Max. door width	Length	Reference
Suspension profile		236 mm	(2x) 110.828
	1000 mm	1000 mm	110.828.100
	1250 mm	1250 mm	110.828.125
	1500 mm	1500 mm	110.828.150
	2000 mm	2000 mm	110.828.200
Bottom guide track	3000 mm	3000 mm	110.828.300
	1000 mm	1000 mm	510.608.100
	1250 mm	1250 mm	510.608.125
	1500 mm	1500 mm	510.608.150
	2000 mm	2000 mm	510.608.200
	3000 mm	3000 mm	510.608.300

Accessories selection

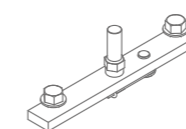

Compact suspension	Superior
Without softclose	BM0.801*
With 1 softclose (min. door width = 562 mm)	BM0.801.020*
With 2 softcloses (min. door width = 807 mm)	BM0.801.220
Unislide** - Fittings to be combined with a hoist (max. 90 kg)	Reference
With 1 softclose	BM0.801.08

Each pocket is adjustable in height and width. Feel free to contact our commercial team at any time to discuss customisation possibilities. Each fitting set comes with all the rollers or soft-close mechanisms, suspension, guiding systems, and stoppers you need.

*The stopper in the cavity can be replaced with an auto-eject (BK9.660) (see p. 5), where the door can be hidden completely in the wall. A slight push on the side of the door brings it back into a position to be closed. In this case, the side of the cavity must always be 100 mm wider than the clear passage. A pocket that is 100 mm wider should be chosen for this. Then the casing profile and running track are adjusted to the correct door width.

**It is possible to combine a pocket door with a hoist system using a Unislide fitting set. This fitting set contains a soft-close mechanism, zero-play roller, auto-eject, and guiding system.

Technical drawings

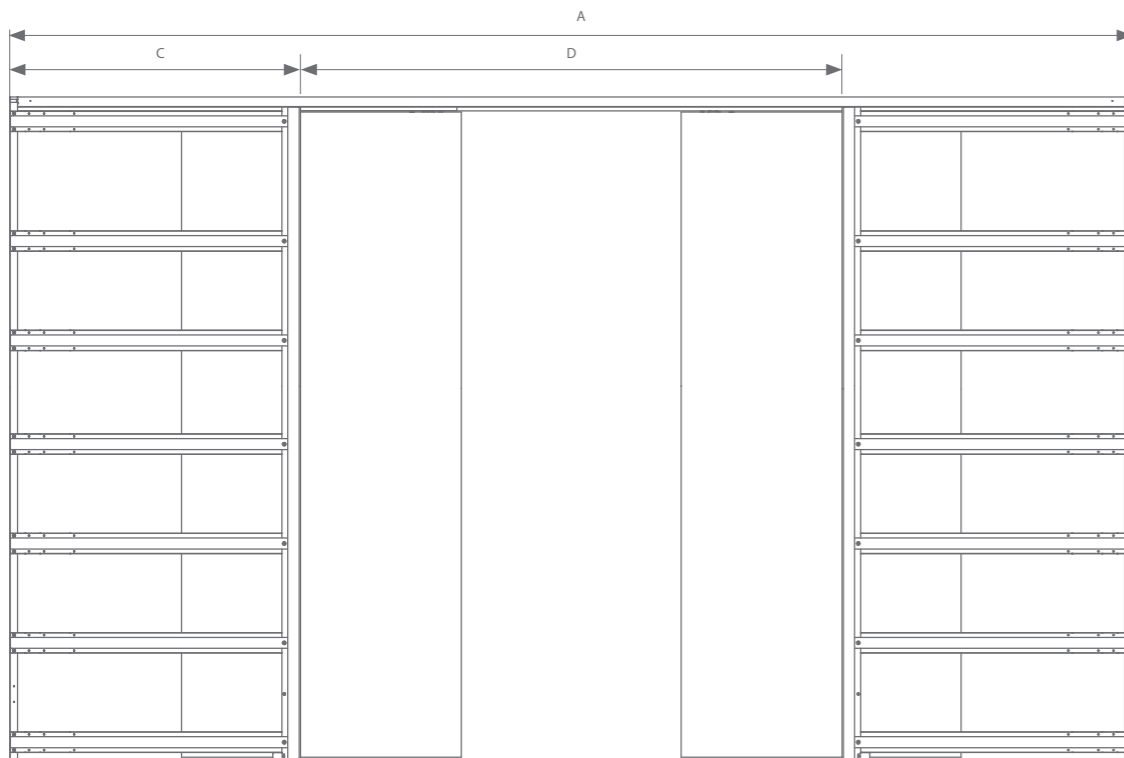

A bundle contains the following items:

- 1 casing profile
- 2 running tracks
- 2 aluminium lead jambs, left
- 2 aluminium lead jambs, right
- 2 steel wall profiles
- horizontal cross rails
- accessories

Not included:

- Grey brush with a length of 2810 mm: BK0.309.281.000 (1 piece)
- Black brush with a length of 2810 mm: BK0.309.281.020 (1 piece)

Bundle

Double pockets for 120 kg doors can always be custom made. Please contact our commercial team for more information.

Additional items required (2x required)

	Max. door width	Length	Reference
Suspension profile		236 mm	(2x) 110.828
	1000 mm	1000 mm	110.828.100
	1250 mm	1250 mm	110.828.125
	1500 mm	1500 mm	110.828.150
	2000 mm	2000 mm	110.828.200
Bottom guide track	3000 mm	3000 mm	110.828.300
	1000 mm	1000 mm	510.608.100
	1250 mm	1250 mm	510.608.125
	1500 mm	1500 mm	510.608.150
	2000 mm	2000 mm	510.608.200
	3000 mm	3000 mm	510.608.300

Accessories selection (2x required)

Compact suspension	Superior
Without softclose	BM0.801*
With 1 softclose (min. door width = 562 mm)	BM0.801.020*
With 2 softcloses (min. door width = 807 mm)	BM0.801.220
Unislide** - Fittings to be combined with a hoist (max. 90 kg)	Reference
With 1 softclose	BM0.801.08

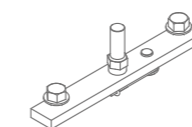

Each fitting set comes with all the rollers or soft-close mechanisms, suspension, guiding systems, and stoppers you need.

*The stopper in the cavity can be replaced with an auto-eject (BK9.660) (see p. 5), where the door can be hidden completely in the wall. A slight push on the side of the door brings it back into a position to be closed. In this case, the side of the cavity must always be 100 mm wider than the clear passage.

**It is possible to combine a pocket door with a hoist system using a Unislide fitting set. This fitting set contains a soft-close mechanism, zero-play roller, auto-eject, and guiding system.

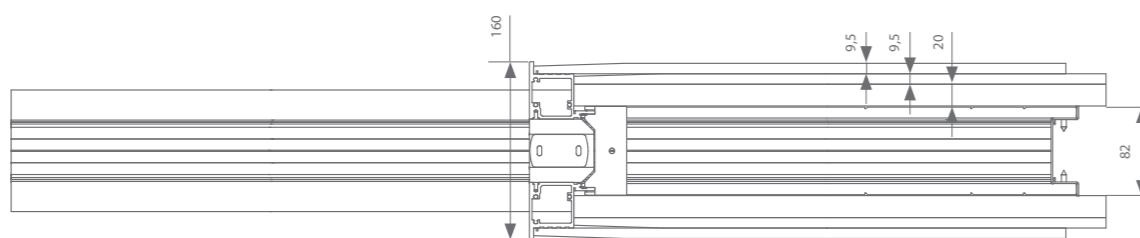



argenta POCKET CORNER SETUP

The pocket can be executed in both weight classes in a corner configuration. The suspension profiles are placed in a miter against each other, each with a removable running track. With this method, we can also provide large openings, even in the corner of a room.

When one door stops before the other, a hook lock can be incorporated into its side to also lock both doors. If interested, please contact our sales department.

Example drawing

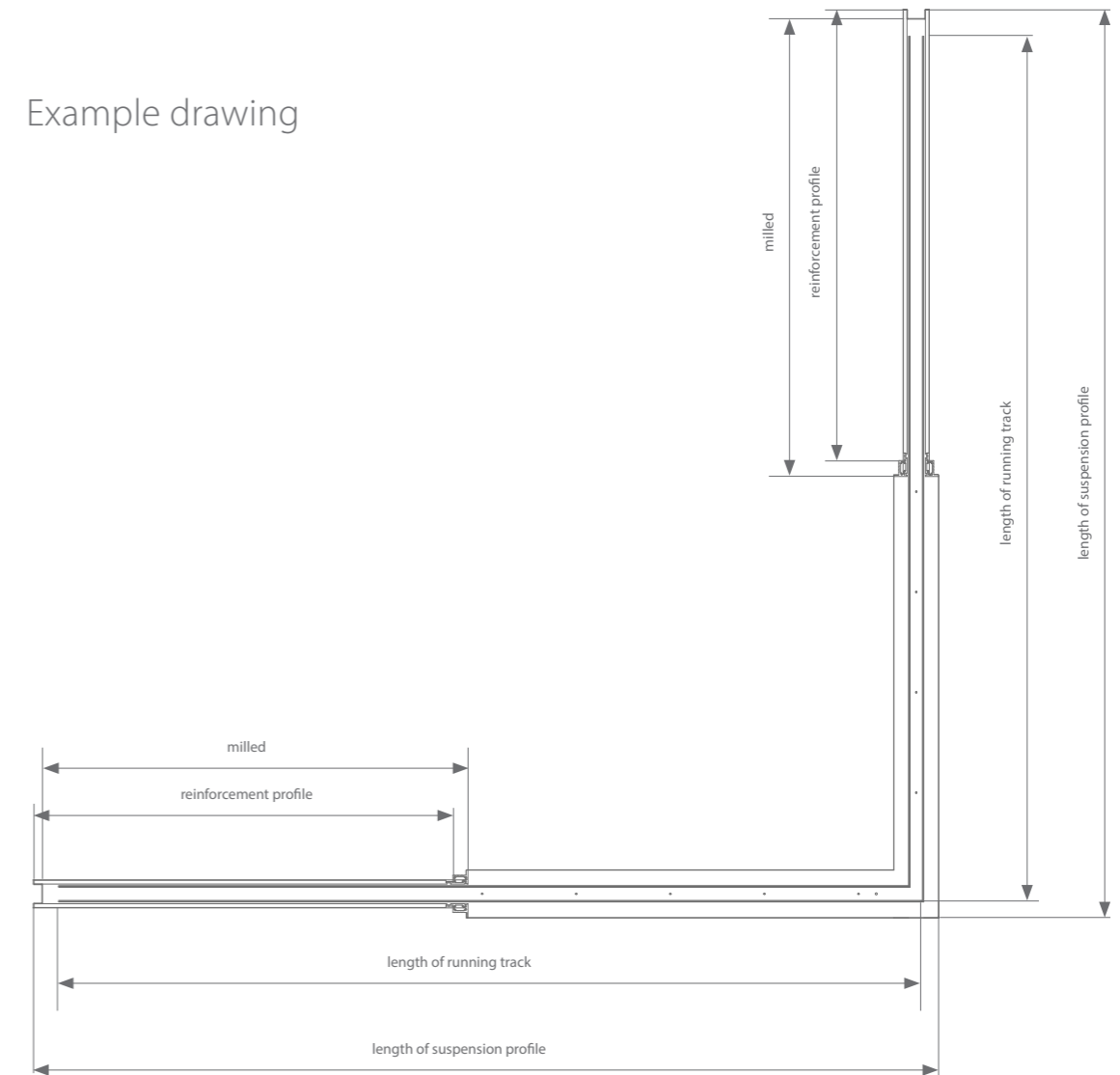



argenta
POCKET 80 KG
FOR GLASS DOORS

Each solution can be extended with a glass package to clamp door thicknesses of 8, 10, or 12 mm and create a minimalist finish in the current pocket.

Technical drawings

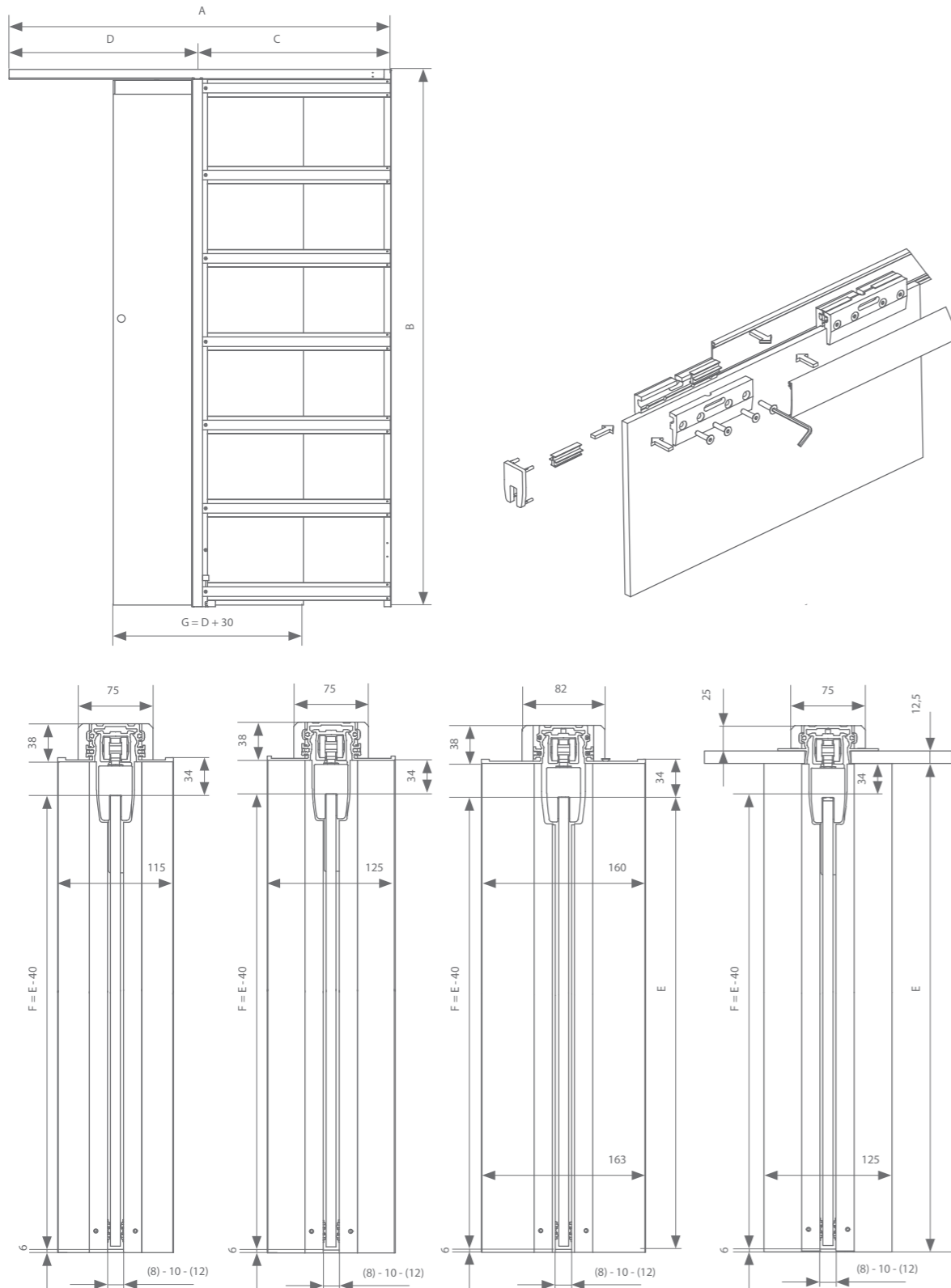

*suitable for 75 mm metal stud

Bundles

Standard	wall thickness 100/115 mm wall thickness 125 mm wall thickness 160 mm	see p. 8 see p. 16 see p. 24
Floor-to-ceiling	wall thickness 125 mm	see p. 32

Cladding profiles

	Content	Brut	Primer
Cladding profile	2 cover profiles L=1,5m + 2 vertical packer profiles L=2,81m	BK0.380	BK0.380.01

End cap

	Glass thickness	Reference
End cap	8 mm 10 mm 12 mm	AK9.978.008 AK9.978.010 AK9.978.012

Accessories selection

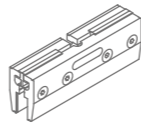
	Compact suspension	Superior
	Without softclose	BK0.500.080
	With 1 softclose (min. door width = 562 mm)	BK0.500.080.20
	With 2 softcloses (min. door width = 807 mm)	BK0.500.082.20

Optional

	Wall thickness	Glass thickness	Reference
Brush L=2 x 2,81m	100/115 mm or 125 mm	8 mm	BK0.379.005
		10 mm 12 mm	BK0.379.005 no Brush provided
Set slam post	wall fix 115 mm wall fix 125 mm ceiling-high door 125 mm	8 mm	773.829.005
		10 mm	AM0.959.005
		12 mm	AM0.959.005
		Brut	Primer
		BK0.398.270 BK0.395.282 BK0.395.282	BK0.398.270.01 BK0.395.282.01 BK0.395.282.01

Technical drawings

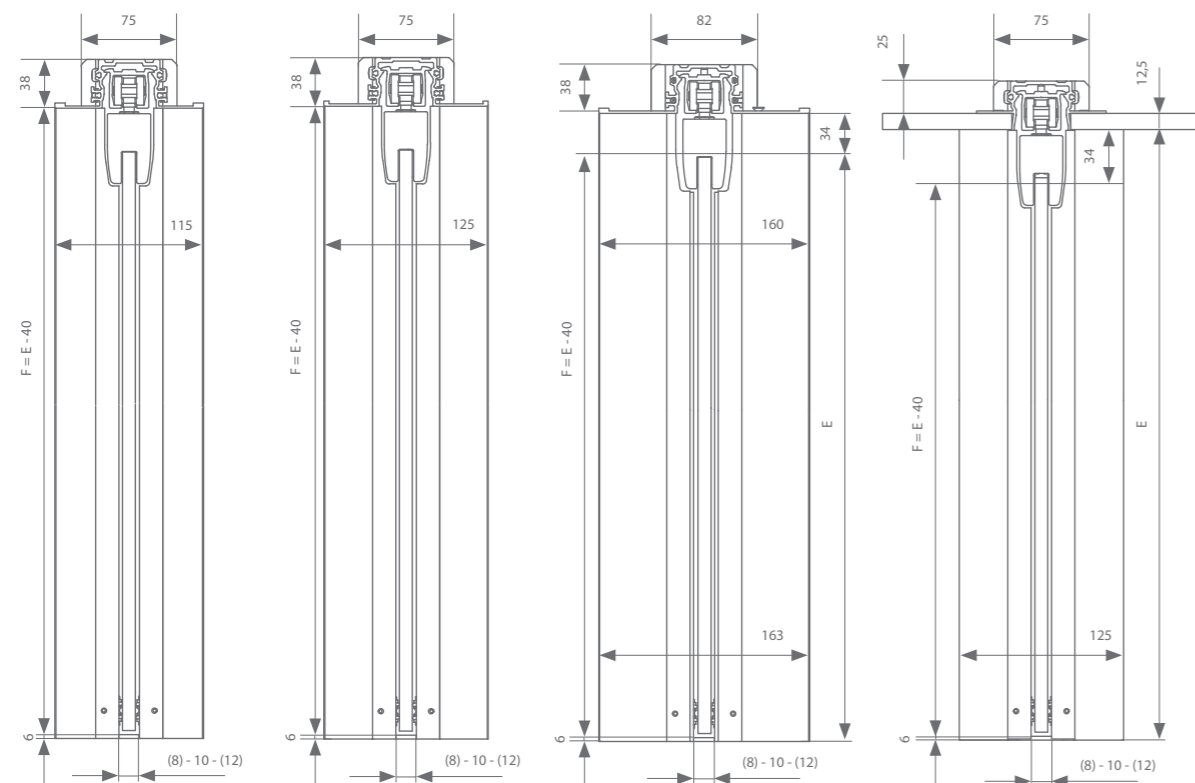
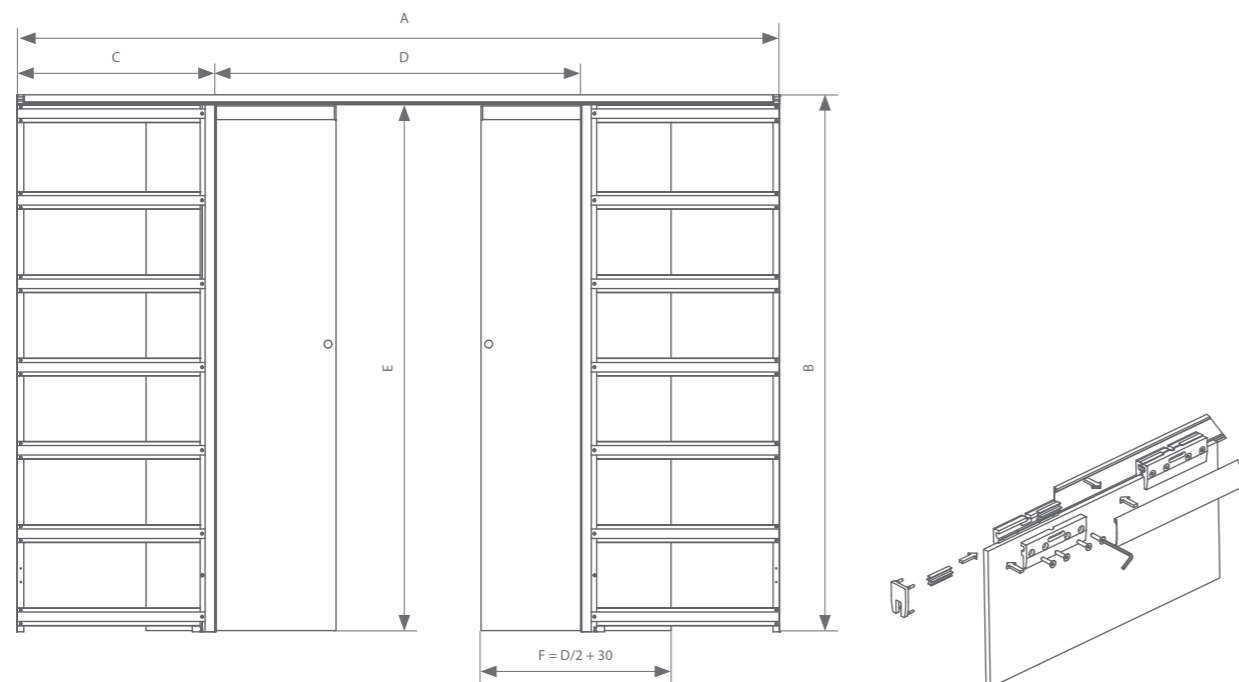

*suitable for 75 mm metal stud

Bundles

Standard	wall thickness 100/115 mm	see p.12
	wall thickness 125 mm	see p. 20
	wall thickness 160 mm	see p. 28
Floor-to-ceiling	wall thickness 125 mm	see p. 34

Cladding profiles (2x required)

	Content	Brut	Primer
Cladding profile	2 cover profiles L=1,5m + 2 vertical packer profiles L=2,81m	BK0.380	BK0.380.01

End cap (2x required)

	Glass thickness	Reference
End cap	8 mm	AK9.978.008
	10 mm	AK9.978.010
	12 mm	AK9.978.012

Accessories selection (2x required)

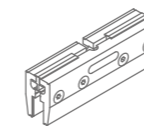

Compact suspension	Superior
Without softclose	BK0.500.080
With 1 softclose (min. door width = 562 mm)	BK0.500.080.20
With 2 softcloses (min. door width = 807 mm)	BK0.500.082.20

Optional (2x required)

	Wall thickness	Glass thickness	Reference
Brush L=2 x 2,81m	100/115 mm or 125 mm	8 mm	BK0.379.005
		10 mm	BK0.379.005
		12 mm	no Brush provided
	160 mm	8 mm	773.829.005
		10 mm	AM0.959.005
		12 mm	AM0.959.005



argenta
POCKET 120 KG
FOR GLASS DOORS

Each solution can be extended with a glass package to clamp door thicknesses of 8, 10, or 12 mm and create a minimalist finish in the current pocket.

Technical drawings

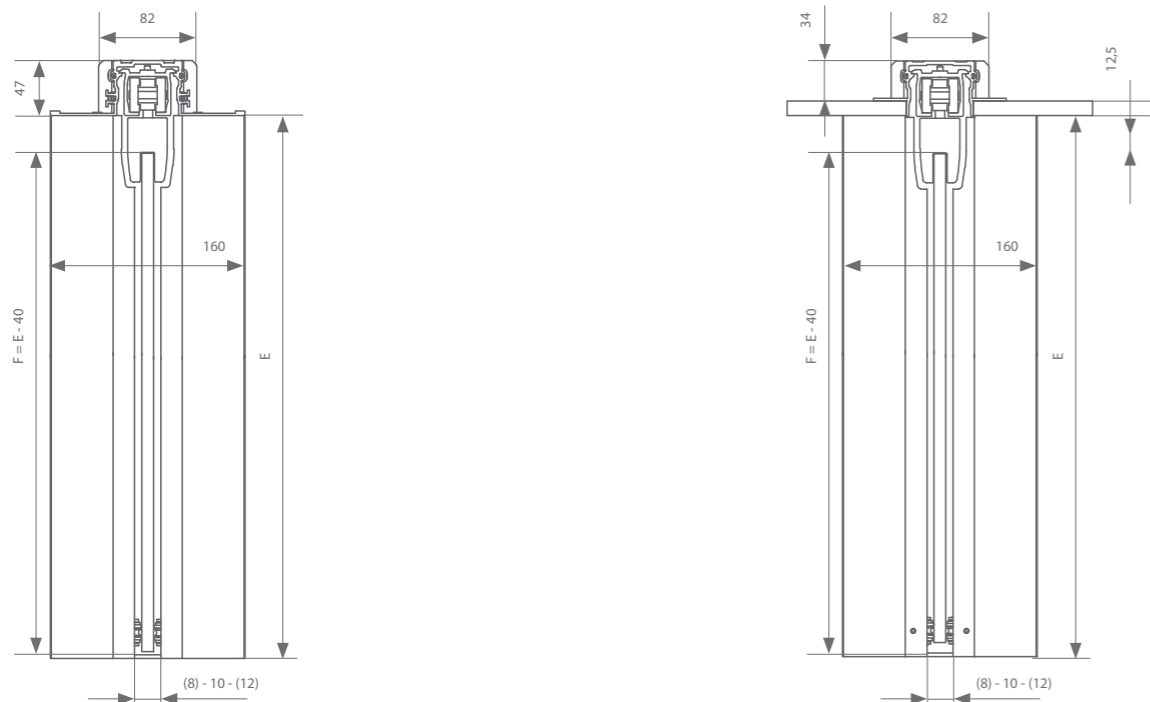
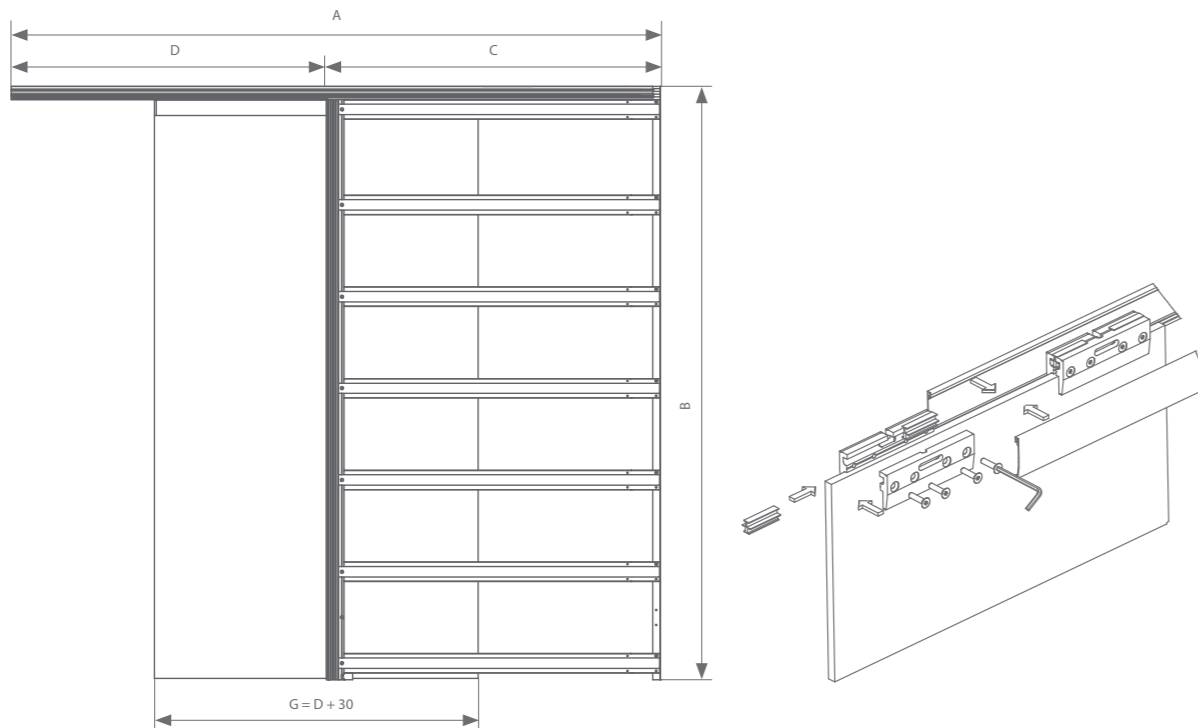

Bundles

Standard	wall thickness 160 mm	see p. 38
Floor-to-ceiling	wall thickness 160 mm	see p. 44

Cladding profiles

	Content	Brut	Primer
Cladding profile	2 cover profiles L=1,5m + 2 vertical packer profiles L=2,81m	BK0.380	BK0.380.01

End cap

	Glass thickness	Reference
End cap	8 mm	AK9.978.008
	10 mm	AK9.978.010
	12 mm	AK9.978.012

Accessories selection

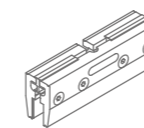

Compact suspension	Superior
Without softclose	BM0.500
With 1 softclose (min. door width = 562 mm)	BM0.500.020
With 2 softcloses (min. door width = 807 mm)	BM0.500.220

Optional

	Wall thickness	Glass thickness	Reference
Brush L=2 x 2,81m	160 mm	8 mm	773.829.005
		10 mm	AM0.959.005
		12 mm	AM0.959.005

Technical drawings

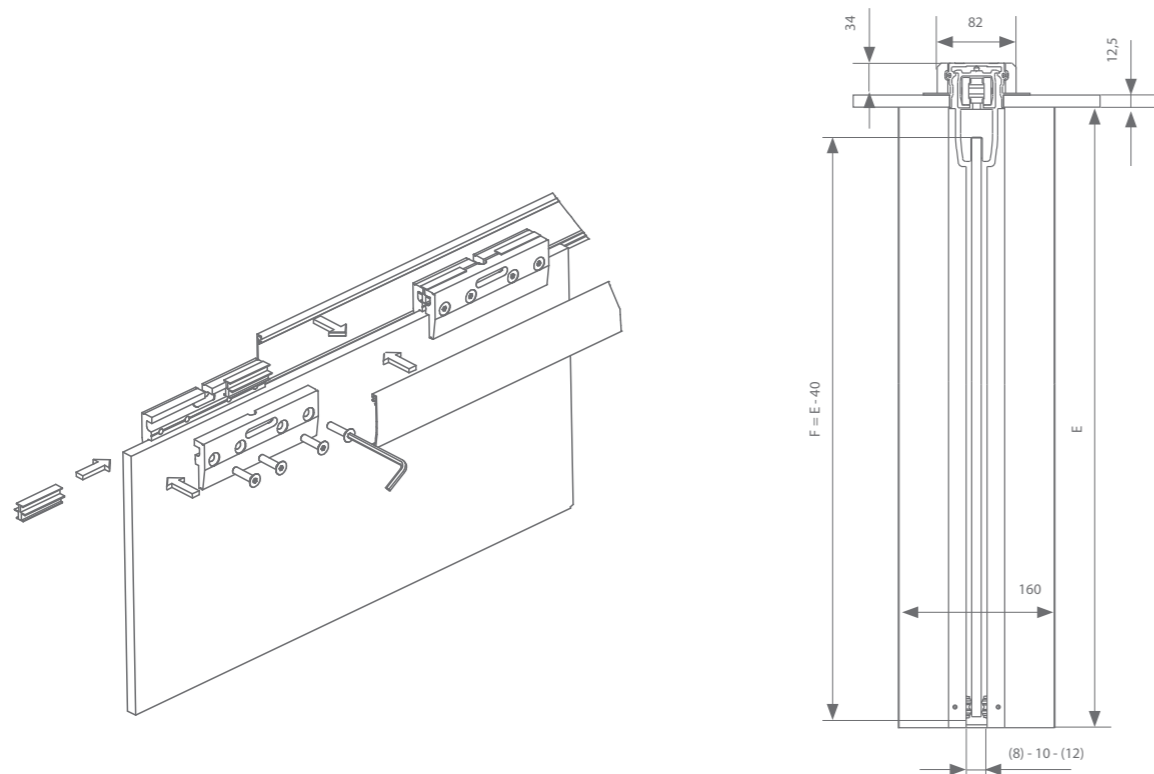
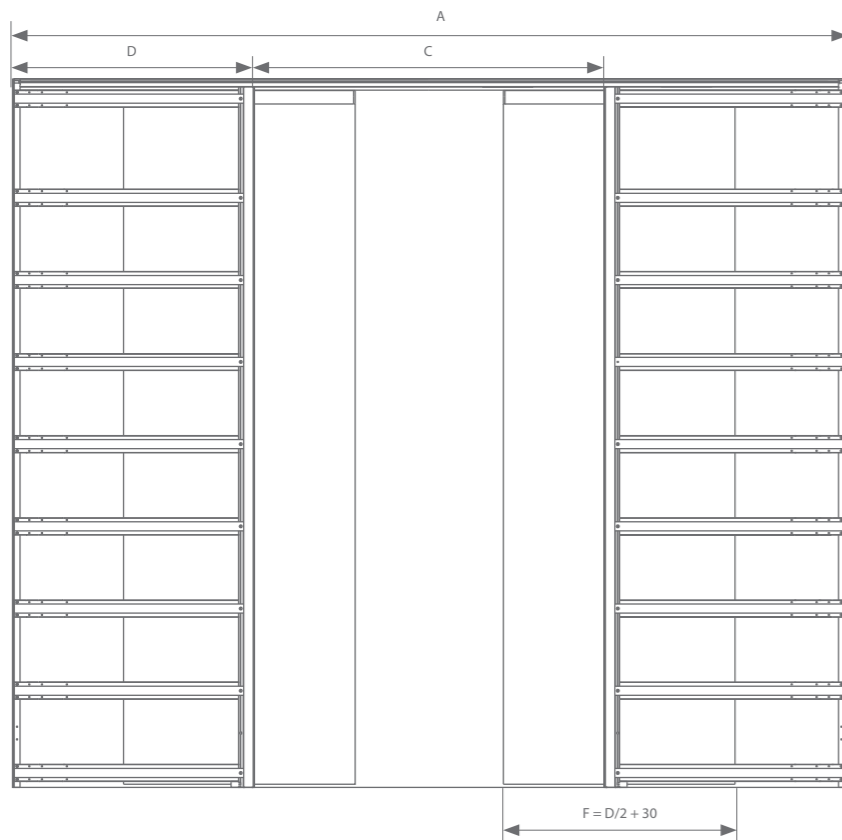

Bundles

Standard	wall thickness 160 mm	see p. 42
Floor-to-ceiling	wall thickness 160 mm	see p. 42

Cladding profiles

	Content	Brut	Primer
Cladding profile	2 cover profiles L=1,5m + 2 vertical packer profiles L=2,81m	BK0.380	BK0.380.01

End cap (2x required)

	Glass thickness	Reference
End cap	8 mm	AK9.978.008
	10 mm	AK9.978.010
	12 mm	AK9.978.012

Accessories selection (2x required)

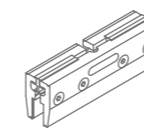

Compact suspension	Superior
Without softclose	BM0.500
With 1 softclose (min. door width = 562 mm)	BM0.500.020
With 2 softcloses (min. door width = 807 mm)	BM0.500.220

Optional (2x required)

	Wall thickness	Glass thickness	Reference
Brush L=2 x 2,81m	160 mm	8 mm	773.829.005
		10 mm	AM0.959.005
		12 mm	AM0.959.005



argenta POCKET SLAM POST

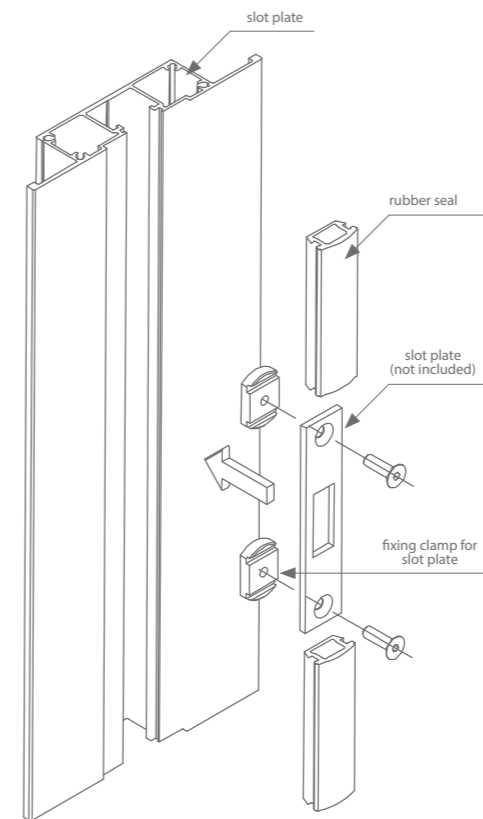

The slam post is suitable for wooden and glass doors. When combined with a wooden door, the grey gasket can be broken through to use a finger plate with a hook lock. Ceiling-high doors are also suitable for this. The profile can be set to any door height with a single saw cut.

*The finger plate is not included; clamping pieces for the finger plate are not included.

Set contains the following items:

- profile L = 2,66 m
- 2 fixing clamps for 20 mm slot plate
- rubber seal
- BK0.398.270 = Brut
- BK0.398.270.01 = Primer

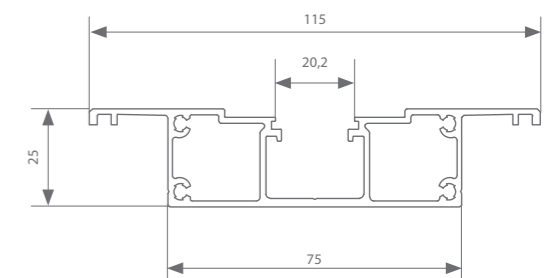

Set contains the following items:

- profile L = 2,82 m
- 2 fixing clamps for 20 mm slot plate
- rubber seal
- BK0.395.282 = Brut
- BK0.395.282.01 = Primer

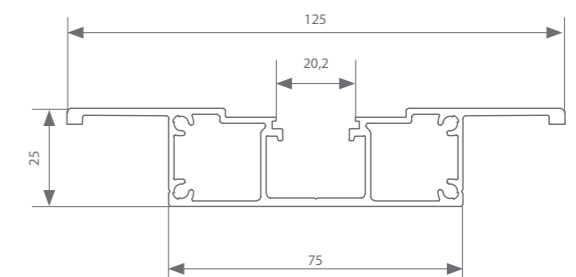



argenta **POCKET UNISLIDE**

The unislide fitting allows the crossing of a sliding door with a hoisting system for less mobile persons and is therefore perfectly applicable in the healthcare sector. The door is suspended by a soft close in the middle and a clearance-free roller at the back. The clearance-free roller prevents the door from tilting, the soft close always allows the door to close gently. Each set is always fitted with an auto-eject so the door opening can be fully used. After a push against the side of the door, it pops out of the pocket and can be closed manually.

Technical drawing

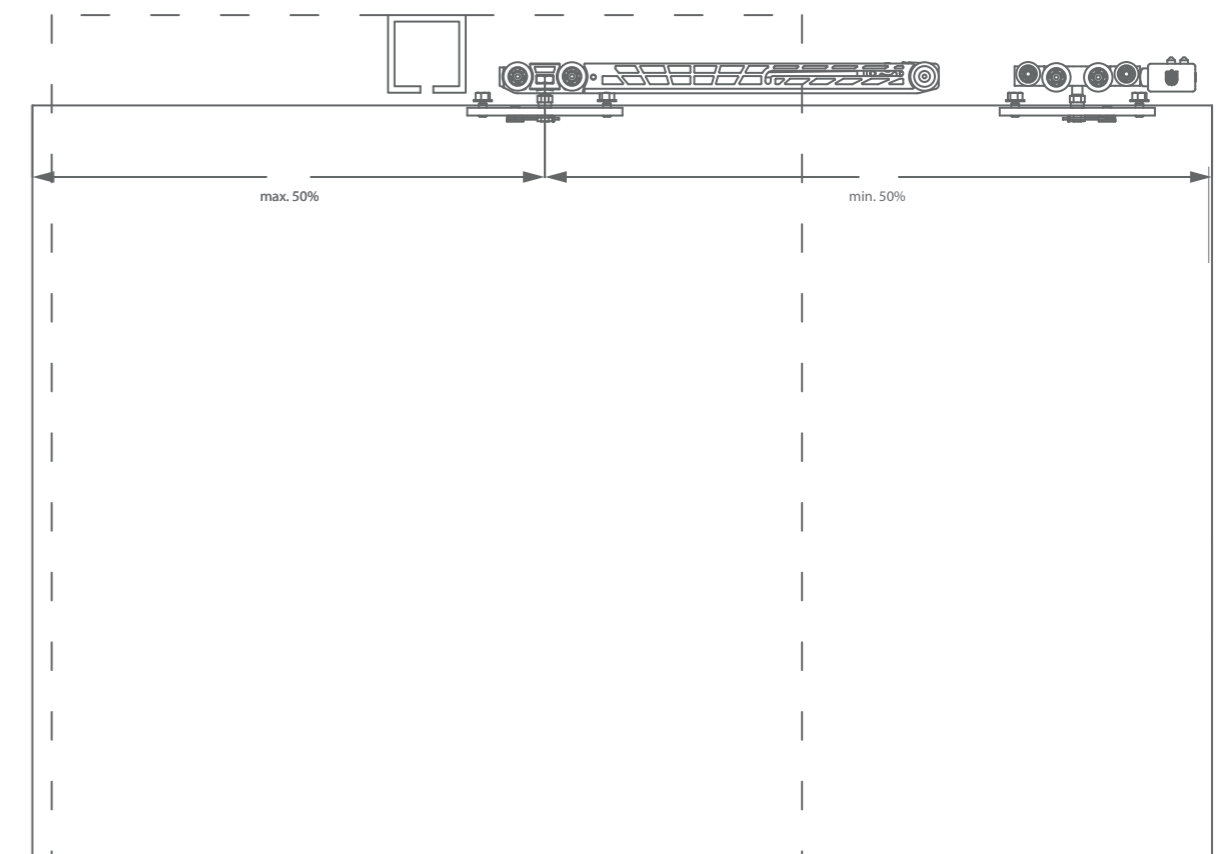



02

LATENT POCKET

Doors sliding into the wall have two major advantages: they are space-saving and very discrete. Nowadays there is a great need for small, compact houses and spaces in which swing doors or doors sliding along the wall are not an option. Our pocket doors sliding into the wall offer an interesting space-saving solution.



argenta latent pocket
General info

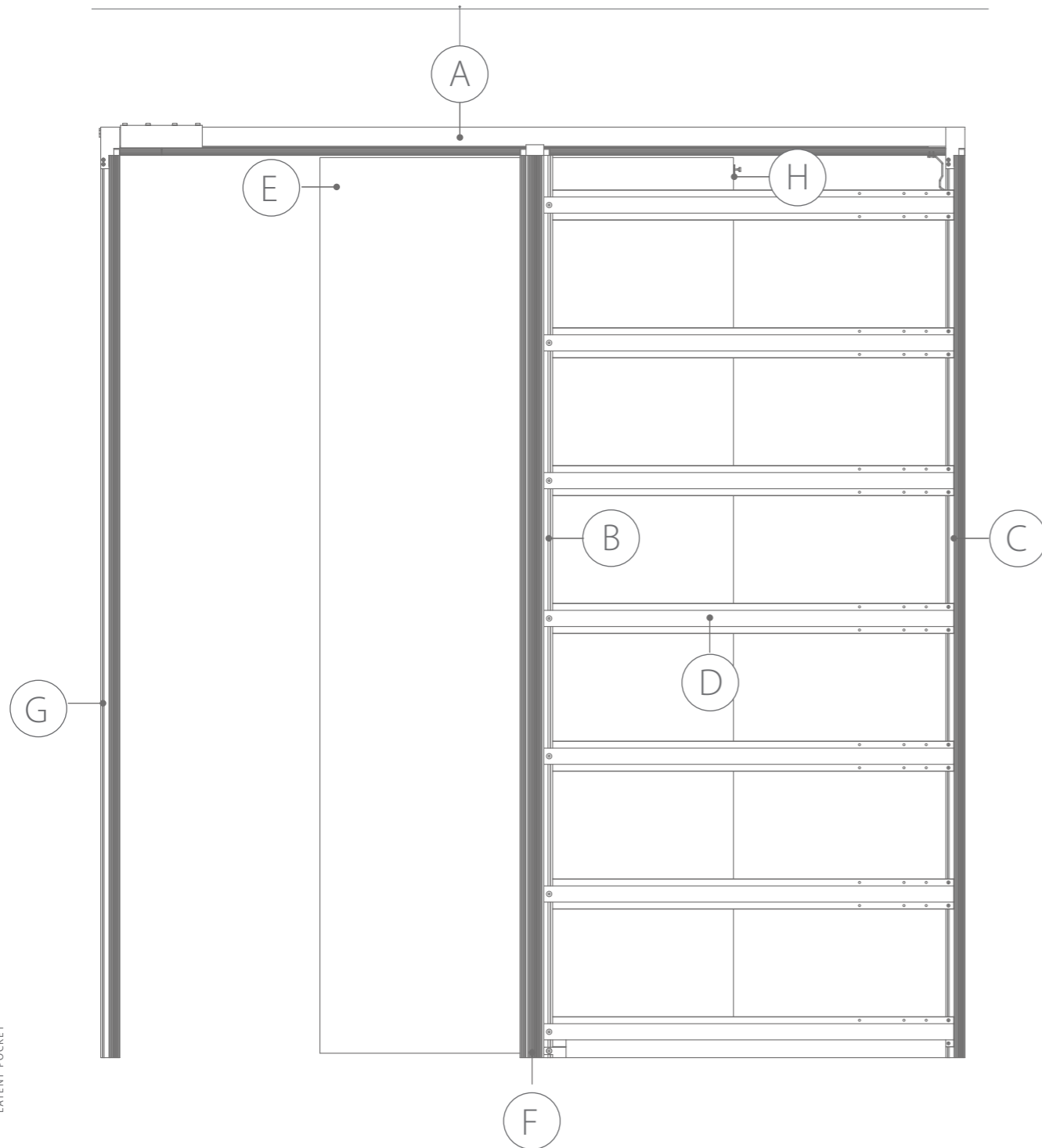

A Latent-pocket owns its minimalist appearance to the combination of the latent running track and a pocket door. In the finishing phase all tracks can be entirely concealed according to the customer's wishes. Besides plasterboard or plaster, this door system offers a large number of finishing options for wall and pocket. The running track can easily be cut to different door widths. Rollers with stoppers or soft close are accessible at all times. Should a deficiency ever occur, the components can be easily replaced without causing any damage.

B The door moves between 2 extremely sturdy aluminium lead jambs. Full modularity was opted when designing these profiles, so that the height can be set quickly with a saw cut. As with the latent track, they are designed to be hidden behind any chosen skirting

C The rear profile, the running track, and floor bracket together create a strong wall by joining both sides of the frame. This profile can also be set to any door height with a single saw cut.

D The strong aluminum profiles are connected with narrow steel cross rails (0.7 mm thick); still, these profiles are very strong so that there's no need to drill before screwing the plasterboards. Steel floor profiles are also fitted as standard just above the floor so that both sides of the wall are connected and the skirting boards are reinforced. The cross rails can be set to different door widths.

E A patented system for compact hanging has been integrated into this product. A suspension profile is to be integrated into the top edge of the door allowing to level the door up to 3mm under the running track.

F The floor guide can be installed at any height. This makes it possible to install the pocket during the construction phase and finish it. The floor guide can only be positioned and the door mounted on the rollers once the floor has been finished and the exact floor level is known.

G Latent-pocket is available for sliding doors of 80 kg and 120 kg for the following 4 types: without slam post, with slam post, with batwing and a double door variant.

H To hide the door completely in the wall, you can select an auto-eject, allowing the door to pop back into the opening by a slight push on the door's edge.



argenta
LATENT POCKET
80 KG

All door heights fit into a dry lining wall of at least 125 mm (EU) or 142 mm (UK) thickness with a maximum weight of 80 kg per door. Each version can also be used at ceiling height. All standard door heights and widths have already been provided with a package. After that, only the choice of fitting set, with an optional auto-eject, remains.

argenta latent pocket 80 kg
 single door min. wall thickness 125 mm
 without slam post*

assemble your set 

Technical drawings

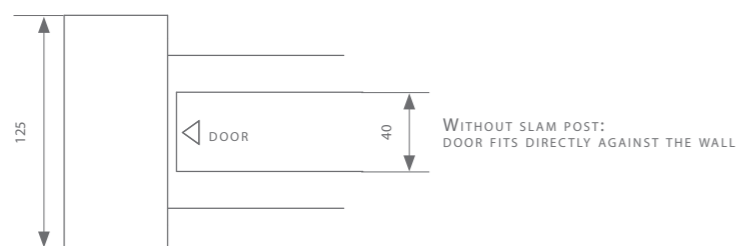
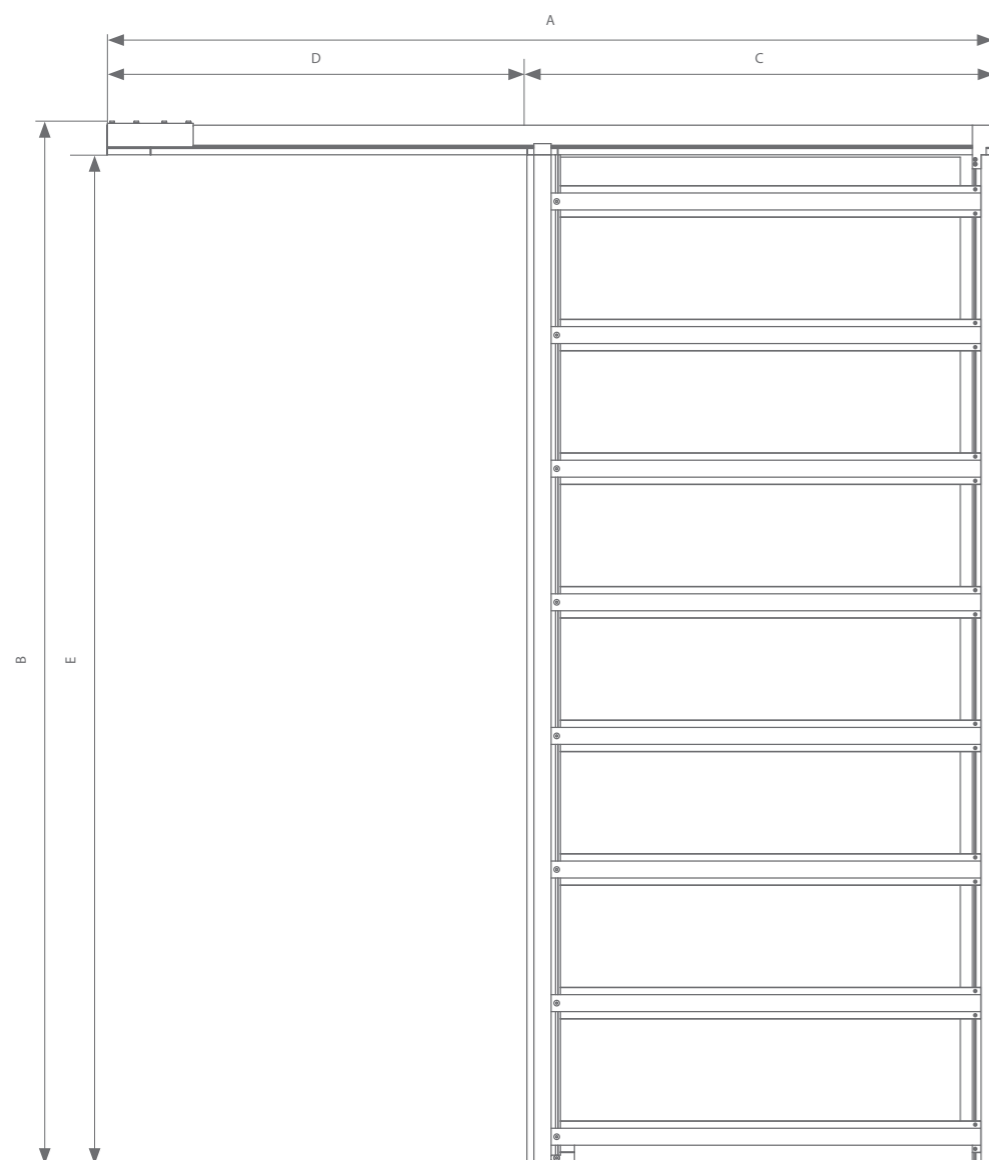

*suitable for 75 mm metal stud

Bundles

Primer	A x B : Recessed installation dimensions	C : Casing Width	D x E : Clear passage	Wooden door panel
BA0.214.073.A	1501 x 2103	801	700 x 2030	730 x 2015
BA0.214.083.A	1701 x 2103	901	800 x 2030	830 x 2015
BA0.214.093.A	1901 x 2103	1001	900 x 2030	930 x 2015
BA0.214.103.A	2101 x 2103	1101	1000 x 2030	1030 x 2015
BA0.214.113.A	2301 x 2103	1201	1100 x 2030	1130 x 2015
BA0.214.123.A	2501 x 2103	1301	1200 x 2030	1230 x 2040
BA0.224.073.A	1501 x 2128	801	700 x 2055	730 x 2040
BA0.224.083.A	1701 x 2128	901	800 x 2055	830 x 2040
BA0.224.093.A	1901 x 2128	1001	900 x 2055	930 x 2040
BA0.224.103.A	2101 x 2128	1101	1000 x 2055	1030 x 2040
BA0.224.113.A	2301 x 2128	1201	1100 x 2055	1130 x 2040
BA0.224.123.A	2501 x 2128	1301	1200 x 2055	1230 x 2040
BA0.234.073.A	1501 x 2203	801	700 x 2130	730 x 2115
BA0.234.083.A	1701 x 2203	901	800 x 2130	830 x 2115
BA0.234.093.A	1901 x 2203	1001	900 x 2130	930 x 2115
BA0.234.103.A	2101 x 2203	1101	1000 x 2130	1030 x 2115
BA0.234.113.A	2301 x 2203	1201	1100 x 2130	1130 x 2115
BA0.234.123.A	2501 x 2203	1301	1200 x 2130	1230 x 2115
BA0.244.073.A	1501 x 2403	801	700 x 2330	730 x 2315
BA0.244.083.A	1701 x 2403	901	800 x 2330	830 x 2315
BA0.244.093.A	1901 x 2403	1001	900 x 2330	930 x 2315
BA0.244.103.A	2101 x 2403	1101	1000 x 2330	1030 x 2315
BA0.244.113.A	2301 x 2403	1201	1100 x 2330	1130 x 2315
BA0.244.123.A	2501 x 2403	1301	1200 x 2330	1230 x 2315
BA0.264.073.A	1501 x 2873	801	700 x 2800	730 x 2785
BA0.264.083.A	1701 x 2873	901	800 x 2800	830 x 2785
BA0.264.093.A	1901 x 2873	1001	900 x 2800	930 x 2785
BA0.264.103.A	2101 x 2873	1101	1000 x 2800	1030 x 2785
BA0.264.113.A	2301 x 2873	1201	1100 x 2800	1130 x 2785
BA0.264.123.A	2501 x 2873	1301	1200 x 2800	1230 x 2785

Accessories selection

Compact suspension	Superior
Without softclose	BA0.801
With 1 softclose (min. door width = 620 mm)*	BA0.801.020
With 2 softcloses (min. door width = 880 mm)*	BA0.801.220

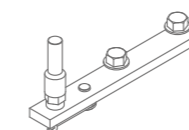

Each fitting set comes with all the rollers or soft-close mechanisms, suspension, guiding systems, and stoppers you need.

*The stopper in the cavity can be replaced with an auto-eject (BA9.660) (see p. 63), where the door can be hidden completely in the wall. A slight push on the side of the door brings it back into a position to be closed.

argenta latent pocket 80 kg
 single door min. wall thickness 125 mm
 with slam post*

assemble your set 

Technical drawings

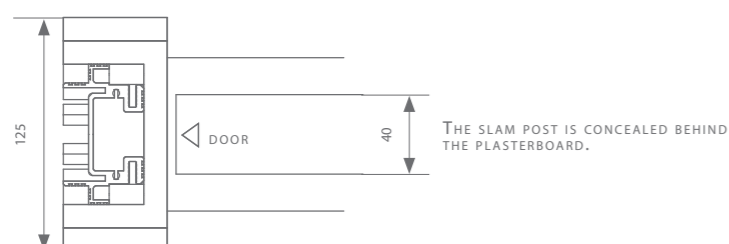
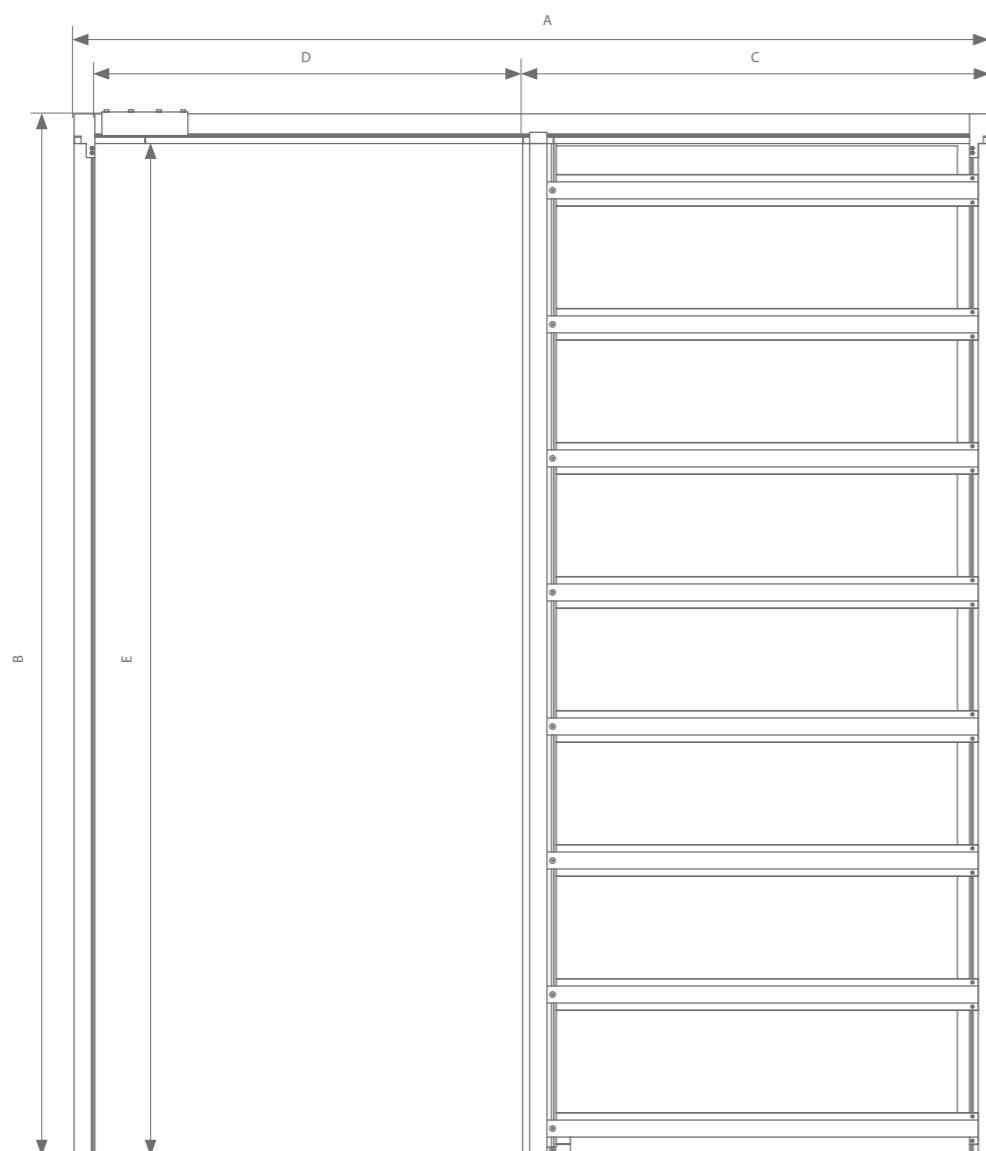

*suitable for 75 mm metal stud

Bundles

Primer	A x B : Recessed installation dimensions	C : Casing Width	D x E : Clear passage	Wooden door panel
BA0.214.073.B	1557 x 2103	801	700 x 2030	730 x 2015
BA0.214.083.B	1757 x 2103	901	800 x 2030	830 x 2015
BA0.214.093.B	1957 x 2103	1001	900 x 2030	930 x 2015
BA0.214.103.B	2157 x 2103	1101	1000 x 2030	1030 x 2015
BA0.214.113.B	2357 x 2103	1201	1100 x 2030	1130 x 2015
BA0.214.123.B	2557 x 2103	1301	1200 x 2030	1230 x 2040
BA0.224.073.B	1557 x 2128	801	700 x 2055	730 x 2040
BA0.224.083.B	1757 x 2128	901	800 x 2055	830 x 2040
BA0.224.093.B	1957 x 2128	1001	900 x 2055	930 x 2040
BA0.224.103.B	2157 x 2128	1101	1000 x 2055	1030 x 2040
BA0.224.113.B	2357 x 2128	1201	1100 x 2055	1130 x 2040
BA0.224.123.B	2557 x 2128	1301	1200 x 2055	1230 x 2040
BA0.234.073.B	1557 x 2203	801	700 x 2130	730 x 2115
BA0.234.083.B	1757 x 2203	901	800 x 2130	830 x 2115
BA0.234.093.B	1957 x 2203	1001	900 x 2130	930 x 2115
BA0.234.103.B	2157 x 2203	1101	1000 x 2130	1030 x 2115
BA0.234.113.B	2357 x 2203	1201	1100 x 2130	1130 x 2115
BA0.234.123.B	2557 x 2203	1301	1200 x 2130	1230 x 2115
BA0.244.073.B	1557 x 2403	801	700 x 2330	730 x 2315
BA0.244.083.B	1757 x 2403	901	800 x 2330	830 x 2315
BA0.244.093.B	1957 x 2403	1001	900 x 2330	930 x 2315
BA0.244.103.B	2157 x 2403	1101	1000 x 2330	1030 x 2315
BA0.244.113.B	2357 x 2403	1201	1100 x 2330	1130 x 2315
BA0.244.123.B	2557 x 2403	1301	1200 x 2330	1230 x 2315
BA0.264.073.B	1557 x 2873	801	700 x 2800	730 x 2785
BA0.264.083.B	1757 x 2873	901	800 x 2800	830 x 2785
BA0.264.093.B	1957 x 2873	1001	900 x 2800	930 x 2785
BA0.264.103.B	2157 x 2873	1101	1000 x 2800	1030 x 2785
BA0.264.113.B	2357 x 2873	1201	1100 x 2800	1130 x 2785
BA0.264.123.B	2557 x 2873	1301	1200 x 2800	1230 x 2785

Accessories selection

Compact suspension	Superior
Without softclose	BA0.801
With 1 softclose (min. door width = 620 mm)*	BA0.801.020
With 2 softcloses (min. door width = 880 mm)*	BA0.801.220

Each fitting set comes with all the rollers or soft-close mechanisms, suspension, guiding systems, and stoppers you need.
 *The stopper inside the cavity can be replaced by an auto eject (BA9.660) (see p.66) so the door can be hidden completely in the wall. A slight push on the side of the door brings it back into a position to be closed.

Bundles

Primer	A x B : Recessed installation dimensions	C : Casing Width	D x E : Clear passage	Wooden door panel
BA0.214.073 .C/D	1547 x 2103	801	700 x 2030	730 x 2015
BA0.214.083 .C/D	1747 x 2103	901	800 x 2030	830 x 2015
BA0.214.093 .C/D	1947 x 2103	1001	900 x 2030	930 x 2015
BA0.214.103 .C/D	2147 x 2103	1101	1000 x 2030	1030 x 2015
BA0.214.113 .C/D	2347 x 2103	1201	1100 x 2030	1130 x 2015
BA0.214.123 .C/D	2547 x 2103	1301	1200 x 2030	1230 x 2040
BA0.224.073 .C/D	1547 x 2128	801	700 x 2055	730 x 2040
BA0.224.083 .C/D	1747 x 2128	901	800 x 2055	830 x 2040
BA0.224.093 .C/D	1947 x 2128	1001	900 x 2055	930 x 2040
BA0.224.103 .C/D	2147 x 2128	1101	1000 x 2055	1030 x 2040
BA0.224.113 .C/D	2347 x 2128	1201	1100 x 2055	1130 x 2040
BA0.224.123 .C/D	2547 x 2128	1301	1200 x 2055	1230 x 2040
BA0.234.073 .C/D	1547 x 2203	801	700 x 2130	730 x 2115
BA0.234.083 .C/D	1747 x 2203	901	800 x 2130	830 x 2115
BA0.234.093 .C/D	1947 x 2203	1001	900 x 2130	930 x 2115
BA0.234.103 .C/D	2147 x 2203	1101	1000 x 2130	1030 x 2115
BA0.234.113 .C/D	2347 x 2203	1201	1100 x 2130	1130 x 2115
BA0.234.123 .C/D	2547 x 2203	1301	1200 x 2130	1230 x 2115
BA0.244.073 .C/D	1547 x 2403	801	700 x 2330	730 x 2315
BA0.244.083 .C/D	1747 x 2403	901	800 x 2330	830 x 2315
BA0.244.093 .C/D	1947 x 2403	1001	900 x 2330	930 x 2315
BA0.244.103 .C/D	2147 x 2403	1101	1000 x 2330	1030 x 2315
BA0.244.113 .C/D	2347 x 2403	1201	1100 x 2330	1130 x 2315
BA0.244.123 .C/D	2547 x 2403	1301	1200 x 2330	1230 x 2315
BA0.264.073 .C/D	1547 x 2873	801	700 x 2800	730 x 2785
BA0.264.083 .C/D	1747 x 2873	901	800 x 2800	830 x 2785
BA0.264.093 .C/D	1947 x 2873	1001	900 x 2800	930 x 2785
BA0.264.103 .C/D	2147 x 2873	1101	1000 x 2800	1030 x 2785
BA0.264.113 .C/D	2347 x 2873	1201	1100 x 2800	1130 x 2785
BA0.264.123 .C/D	2547 x 2873	1301	1200 x 2800	1230 x 2785

Version C cannot be used for hook locks. In Version D, the slam post is equipped with milled notches and a lock housing. With this version, a hook lock of your choice is required.

Hook lock

Brand	Reference
Hook lock AGB	80000196
Hook lock KfV	80000197

*suitable for 75 mm metal stud

Accessories selection

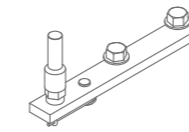

Compact suspension	Superior
Without softclose	BA0.801
With 1 softclose (min. door width = 620 mm)*	BA0.801.020
With 2 softcloses (min. door width = 880 mm)*	BA0.801.220

Technical drawings

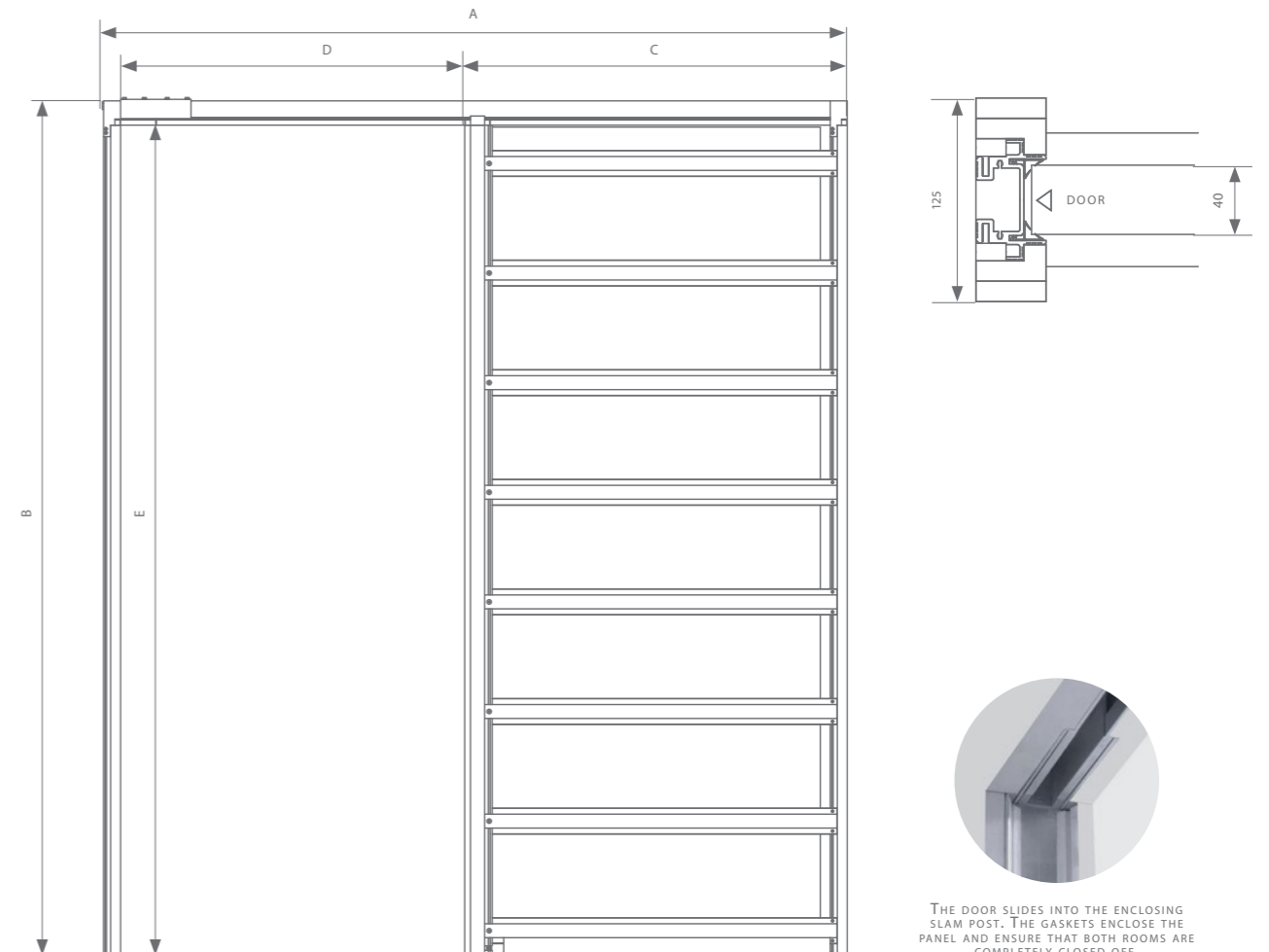

THE DOOR SLIDES INTO THE ENCLOSING SLAM POST. THE GASKETS ENCLOSE THE PANEL AND ENSURE THAT BOTH ROOMS ARE COMPLETELY CLOSED OFF.

Each fitting set comes with all the rollers or soft-close mechanisms, suspension, guiding systems, and stoppers you need.
*Version C cannot be used for hook locks. In Version D, the slam post is equipped with milled notches and a lock housing. With this version, a hook lock of your choice is required.
** The stopper in the cavity can be replaced with an auto-eject (BA9.660) (see p.66) so the door can be hidden completely in the wall. A slight push on the side of the door brings it back into a position to be closed.

Bundles

Primer	A x B : Recessed installation dimensions	C : Casing Width	D x E : Clear passage	Wooden door panel
BA0.214.073.A2	3001 x 2103	801	1400 x 2030	730 x 2015
BA0.214.083.A2	3401 x 2103	901	1600 x 2030	830 x 2015
BA0.214.093.A2	3801 x 2103	1001	1800 x 2030	930 x 2015
BA0.214.103.A2	4201 x 2103	1101	2000 x 2030	1030 x 2015
BA0.214.113.A2	4601 x 2103	1201	2200 x 2030	1130 x 2015
BA0.214.123.A2	5001 x 2103	1301	2400 x 2030	1230 x 2040
BA0.224.073.A2	3001 x 2128	801	1400 x 2055	730 x 2040
BA0.224.083.A2	3401 x 2128	901	1600 x 2055	830 x 2040
BA0.224.093.A2	3801 x 2128	1001	1800 x 2055	930 x 2040
BA0.224.103.A2	4201 x 2128	1101	2000 x 2055	1030 x 2040
BA0.224.113.A2	4601 x 2128	1201	2200 x 2055	1130 x 2040
BA0.224.123.A2	5001 x 2128	1301	2400 x 2055	1230 x 2040
BA0.234.073.A2	3001 x 2203	801	1400 x 2130	730 x 2115
BA0.234.083.A2	3401 x 2203	901	1600 x 2130	830 x 2115
BA0.234.093.A2	3801 x 2203	1001	1800 x 2130	930 x 2115
BA0.234.103.A2	4201 x 2203	1101	2000 x 2130	1030 x 2115
BA0.234.113.A2	4601 x 2203	1201	2200 x 2130	1130 x 2115
BA0.234.123.A2	5001 x 2203	1301	2400 x 2130	1230 x 2115
BA0.244.073.A2	3001 x 2403	801	1400 x 2330	730 x 2315
BA0.244.083.A2	3401 x 2403	901	1600 x 2330	830 x 2315
BA0.244.093.A2	3801 x 2403	1001	1800 x 2330	930 x 2315
BA0.244.103.A2	4201 x 2403	1101	2000 x 2330	1030 x 2315
BA0.244.113.A2	4601 x 2403	1201	2200 x 2330	1130 x 2315
BA0.244.123.A2	5001 x 2403	1301	2400 x 2330	1230 x 2315
BA0.264.073.A2	3001 x 2873	801	1400 x 2800	730 x 2785
BA0.264.083.A2	3401 x 2873	901	1600 x 2800	830 x 2785
BA0.264.093.A2	3801 x 2873	1001	1800 x 2800	930 x 2785
BA0.264.103.A2	4201 x 2873	1101	2000 x 2800	1030 x 2785
BA0.264.113.A2	4601 x 2873	1201	2200 x 2800	1130 x 2785
BA0.264.123.A2	5001 x 2873	1301	2400 x 2800	1230 x 2785

*suitable for 75 mm metal stud

Accessories selection

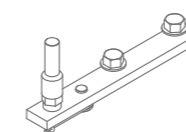

Compact suspension	Superior
Without softclose	BA0.801
With 1 softclose (min. door width = 570 mm)*	BA0.801.020
With 2 softcloses (min. door width = 830 mm)*	BA0.801.220

Technical drawings

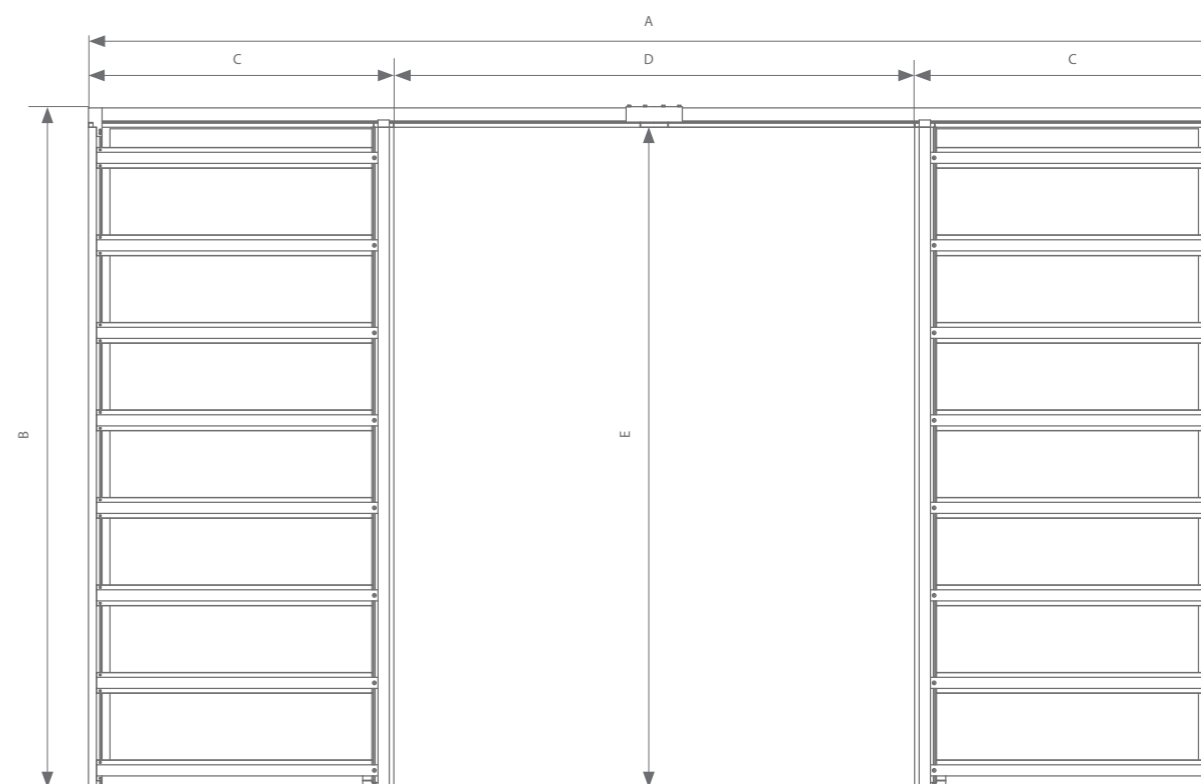

Each fitting set comes with all the rollers or soft-close mechanisms, suspension, guiding systems, and stoppers you need.

*The stopper in the cavity can be replaced with an auto-eject (BA9.660) (see p.66) so the door can be hidden completely in the wall. A slight push on the side of the door brings it back into a position to be closed.



argenta
LATENT POCKET
120 KG

All door heights fit into a cavity with a minimum thickness of 125 mm and a maximum weight of 120 kg per door. Each version can also be used at ceiling height. All standard door heights and widths have already been provided with a package. After that, only the choice of fitting set, with an optional auto-eject, remains.

argenta latent pocket 120 kg
 single door min. wall thickness 125 mm
 without slam post*

assemble your set 

Technical drawings

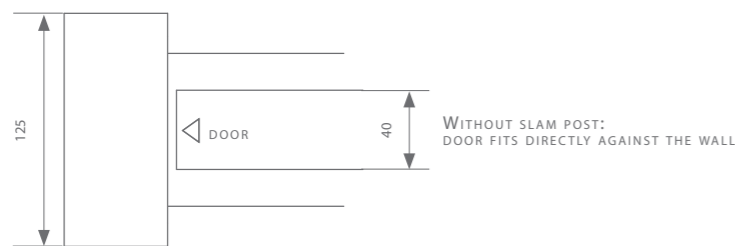
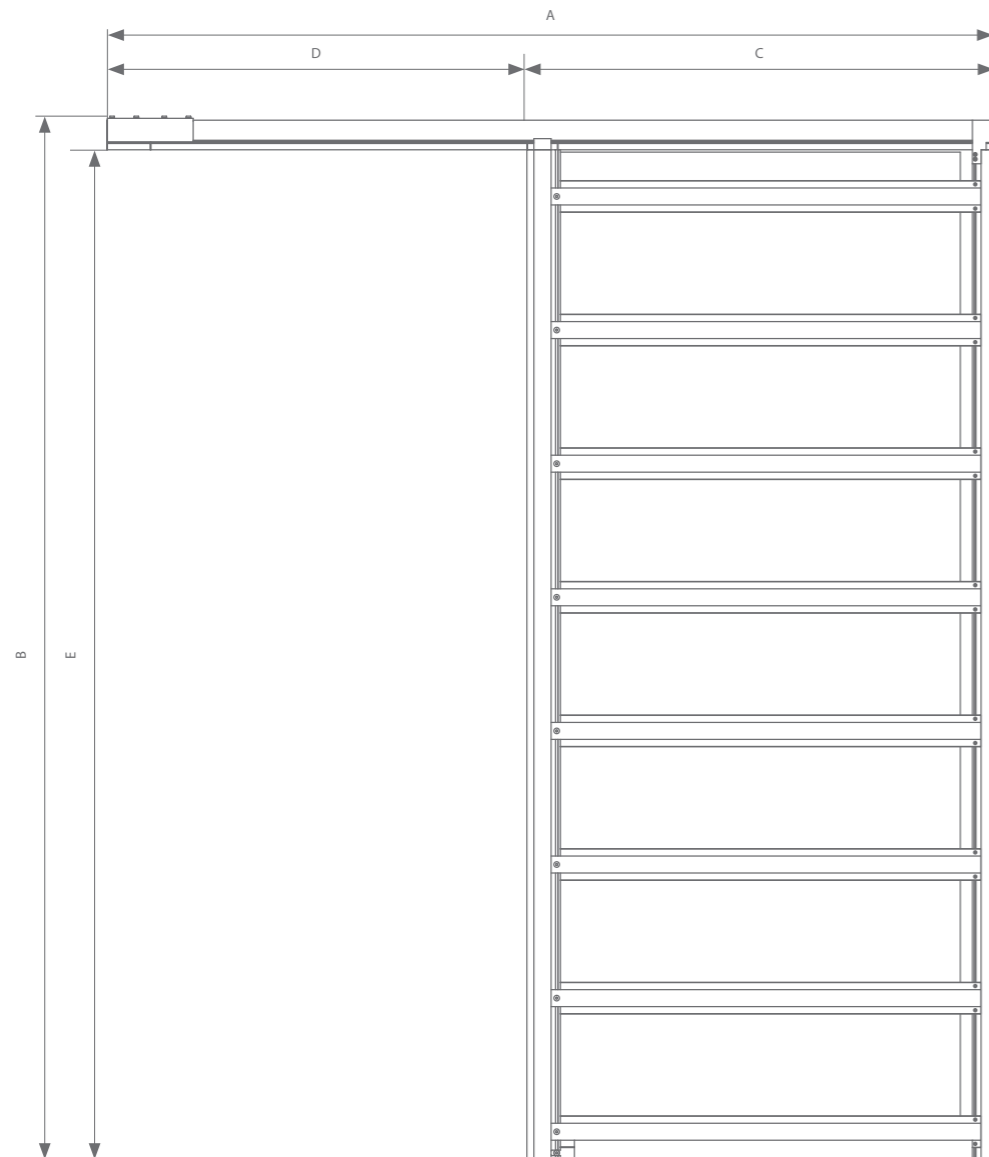

*suitable for 75 mm metal stud

Bundles

Primer	A x B : Recessed installation dimensions	C : Casing Width	D x E : Clear passage	Wooden door panel
BC0.214.073.A	1501 x 2113	801	700 x 2030	730 x 2015
BC0.214.083.A	1701 x 2113	901	800 x 2030	830 x 2015
BC0.214.093.A	1901 x 2113	1001	900 x 2030	930 x 2015
BC0.214.103.A	2101 x 2113	1101	1000 x 2030	1030 x 2015
BC0.214.113.A	2301 x 2113	1201	1100 x 2030	1130 x 2015
BC0.214.123.A	2501 x 2113	1301	1200 x 2030	1230 x 2015
BC0.224.073.A	1501 x 2138	801	700 x 2055	730 x 2040
BC0.224.083.A	1701 x 2138	901	800 x 2055	830 x 2040
BC0.224.093.A	1901 x 2138	1001	900 x 2055	930 x 2040
BC0.224.103.A	2101 x 2138	1101	1000 x 2055	1030 x 2040
BC0.224.113.A	2301 x 2138	1201	1100 x 2055	1130 x 2040
BC0.224.123.A	2501 x 2138	1301	1200 x 2055	1230 x 2040
BC0.234.073.A	1501 x 2213	801	700 x 2130	730 x 2115
BC0.234.083.A	1701 x 2213	901	800 x 2130	830 x 2115
BC0.234.093.A	1901 x 2213	1001	900 x 2130	930 x 2115
BC0.234.103.A	2101 x 2213	1101	1000 x 2130	1030 x 2115
BC0.234.113.A	2301 x 2213	1201	1100 x 2130	1130 x 2115
BC0.234.123.A	2501 x 2213	1301	1200 x 2130	1230 x 2115
BC0.244.073.A	1501 x 2413	801	700 x 2330	730 x 2315
BC0.244.083.A	1701 x 2413	901	800 x 2330	830 x 2315
BC0.244.093.A	1901 x 2413	1001	900 x 2330	930 x 2315
BC0.244.103.A	2101 x 2413	1101	1000 x 2330	1030 x 2315
BC0.244.113.A	2301 x 2413	1201	1100 x 2330	1130 x 2315
BC0.244.123.A	2501 x 2413	1301	1200 x 2330	1230 x 2315
BC0.264.073.A	1501 x 2883	801	700 x 2800	730 x 2785
BC0.264.083.A	1701 x 2883	901	800 x 2800	830 x 2785
BC0.264.093.A	1901 x 2883	1001	900 x 2800	930 x 2785
BC0.264.103.A	2101 x 2883	1101	1000 x 2800	1030 x 2785
BC0.264.113.A	2301 x 2883	1201	1100 x 2800	1130 x 2785
BC0.264.123.A	2501 x 2883	1301	1200 x 2800	1230 x 2785

Accessories selection

Compact suspension	Superior
Without softclose	BC0.801
With 1 softclose (min. door width = 665 mm)*	BC0.801.020

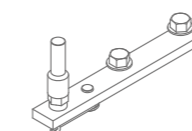

Each fitting set comes with all the rollers or soft-close mechanisms, suspension, guiding systems, and stoppers you need.

*The stopper in the cavity can be replaced with an auto-eject (BC9.660) (see p.66) so the door can be hidden completely in the wall. A slight push on the side of the door brings it back into a position to be closed.

argenta latent pocket 120 kg
 single door min. wall thickness 125 mm
 with slam post*

assemble your set 

Technical drawings

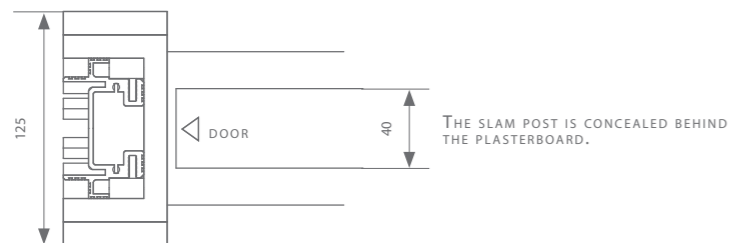
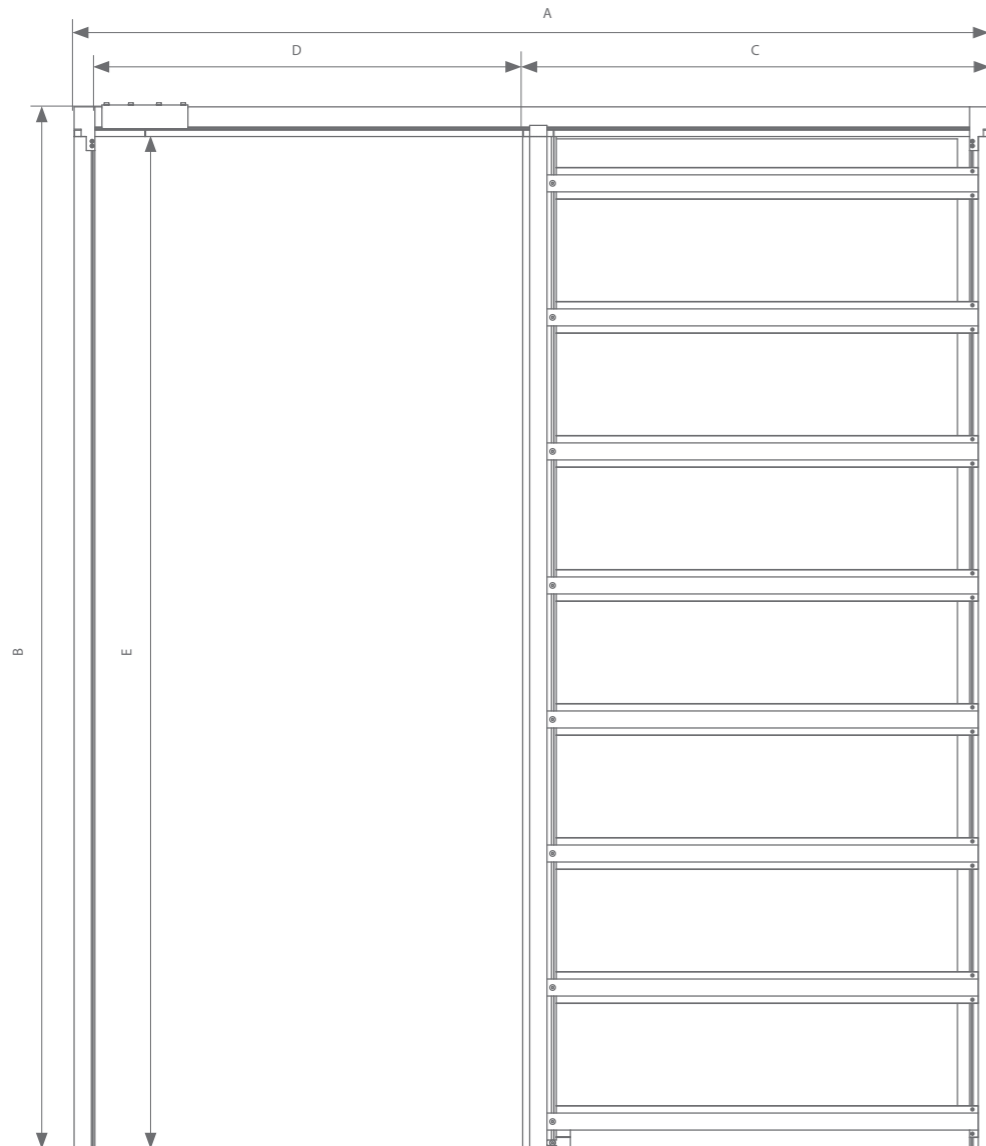

*suitable for 75 mm metal stud

Bundles

Primer	A x B : Recessed installation dimensions	C : Casing Width	D x E : Clear passage	Wooden door panel
BC0.214.073.B	1557 x 2113	801	700 x 2030	730 x 2015
BC0.214.083.B	1757 x 2113	901	800 x 2030	830 x 2015
BC0.214.093.B	1957 x 2113	1001	900 x 2030	930 x 2015
BC0.214.103.B	2157 x 2113	1101	1000 x 2030	1030 x 2015
BC0.214.113.B	2357 x 2113	1201	1100 x 2030	1130 x 2015
BC0.214.123.B	2557 x 2113	1301	1200 x 2030	1230 x 2040
BC0.224.073.B	1557 x 2138	801	700 x 2055	730 x 2040
BC0.224.083.B	1757 x 2138	901	800 x 2055	830 x 2040
BC0.224.093.B	1957 x 2138	1001	900 x 2055	930 x 2040
BC0.224.103.B	2157 x 2138	1101	1000 x 2055	1030 x 2040
BC0.224.113.B	2357 x 2138	1201	1100 x 2055	1130 x 2040
BC0.224.123.B	2557 x 2138	1301	1200 x 2055	1230 x 2040
BC0.234.073.B	1557 x 2213	801	700 x 2130	730 x 2115
BC0.234.083.B	1757 x 2213	901	800 x 2130	830 x 2115
BC0.234.093.B	1957 x 2213	1001	900 x 2130	930 x 2115
BC0.234.103.B	2157 x 2213	1101	1000 x 2130	1030 x 2115
BC0.234.113.B	2357 x 2213	1201	1100 x 2130	1130 x 2115
BC0.234.123.B	2557 x 2213	1301	1200 x 2130	1230 x 2115
BC0.244.073.B	1557 x 2413	801	700 x 2330	730 x 2315
BC0.244.083.B	1757 x 2413	901	800 x 2330	830 x 2315
BC0.244.093.B	1957 x 2413	1001	900 x 2330	930 x 2315
BC0.244.103.B	2157 x 2413	1101	1000 x 2330	1030 x 2315
BC0.244.113.B	2357 x 2413	1201	1100 x 2330	1130 x 2315
BC0.244.123.B	2557 x 2413	1301	1200 x 2330	1230 x 2315
BC0.264.073.B	1557 x 2883	801	700 x 2800	730 x 2785
BC0.264.083.B	1757 x 2883	901	800 x 2800	830 x 2785
BC0.264.093.B	1957 x 2883	1001	900 x 2800	930 x 2785
BC0.264.103.B	2157 x 2883	1101	1000 x 2800	1030 x 2785
BC0.264.113.B	2357 x 2883	1201	1100 x 2800	1130 x 2785
BC0.264.123.B	2557 x 2883	1301	1200 x 2800	1230 x 2785

Accessories selection

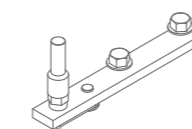

Compact suspension	Superior
Without softclose	BC0.801
With 1 softclose (min. door width = 665 mm)*	BC0.801.020

Each fitting set comes with all the rollers or soft-close mechanisms, suspension, guiding systems, and stoppers you need.

*The stopper in the cavity can be replaced with an auto-eject (BC9.660) (see p.66) so the door can be hidden completely in the wall. A slight push on the side of the door brings it back into a position to be closed. De kant van de valse wand moet hierbij steeds 100 mm breder zijn dan de vrije doorgang. A pocket that is 100 mm wider should be chosen for this. Then the casing profile and running track are adjusted to the correct door width.

Bundles

Primer	A x B : Recessed installation dimensions	C : Casing Width	D x E : Clear passage	Wooden door panel
BC0.214.073 .C/D	1547 x 2113	801	700 x 2030	730 x 2015
BC0.214.083 .C/D	1747 x 2113	901	800 x 2030	830 x 2015
BC0.214.093 .C/D	1947 x 2113	1001	900 x 2030	930 x 2015
BC0.214.103 .C/D	2147 x 2113	1101	1000 x 2030	1030 x 2015
BC0.214.113 .C/D	2347 x 2113	1201	1100 x 2030	1130 x 2015
BC0.214.123 .C/D	2547 x 2113	1301	1200 x 2030	1230 x 2040
BC0.224.073 .C/D	1547 x 2138	801	700 x 2055	730 x 2040
BC0.224.083 .C/D	1747 x 2138	901	800 x 2055	830 x 2040
BC0.224.093 .C/D	1947 x 2138	1001	900 x 2055	930 x 2040
BC0.224.103 .C/D	2147 x 2138	1101	1000 x 2055	1030 x 2040
BC0.224.113 .C/D	2347 x 2138	1201	1100 x 2055	1130 x 2040
BC0.224.123 .C/D	2547 x 2138	1301	1200 x 2055	1230 x 2040
BC0.234.073 .C/D	1547 x 2213	801	700 x 2130	730 x 2115
BC0.234.083 .C/D	1747 x 2213	901	800 x 2130	830 x 2115
BC0.234.093 .C/D	1947 x 2213	1001	900 x 2130	930 x 2115
BC0.234.103 .C/D	2147 x 2213	1101	1000 x 2130	1030 x 2115
BC0.234.113 .C/D	2347 x 2213	1201	1100 x 2130	1130 x 2115
BC0.234.123 .C/D	2547 x 2213	1301	1200 x 2130	1230 x 2115
BC0.244.073 .C/D	1547 x 2413	801	700 x 2330	730 x 2315
BC0.244.083 .C/D	1747 x 2413	901	800 x 2330	830 x 2315
BC0.244.093 .C/D	1947 x 2413	1001	900 x 2330	930 x 2315
BC0.244.103 .C/D	2147 x 2413	1101	1000 x 2330	1030 x 2315
BC0.244.113 .C/D	2347 x 2413	1201	1100 x 2330	1130 x 2315
BC0.244.123 .C/D	2547 x 2413	1301	1200 x 2330	1230 x 2315
BC0.264.073 .C/D	1547 x 2883	801	700 x 2800	730 x 2785
BC0.264.083 .C/D	1747 x 2883	901	800 x 2800	830 x 2785
BC0.264.093 .C/D	1947 x 2883	1001	900 x 2800	930 x 2785
BC0.264.103 .C/D	2147 x 2883	1101	1000 x 2800	1030 x 2785
BC0.264.113 .C/D	2347 x 2883	1201	1100 x 2800	1130 x 2785
BC0.264.123 .C/D	2547 x 2883	1301	1200 x 2800	1230 x 2785

Accessories selection

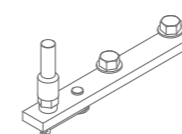

Compact suspension	Superior
Without softclose	BC0.801
With 1 softclose (min. door width = 665 mm)**	BC0.801.020

Technical drawings

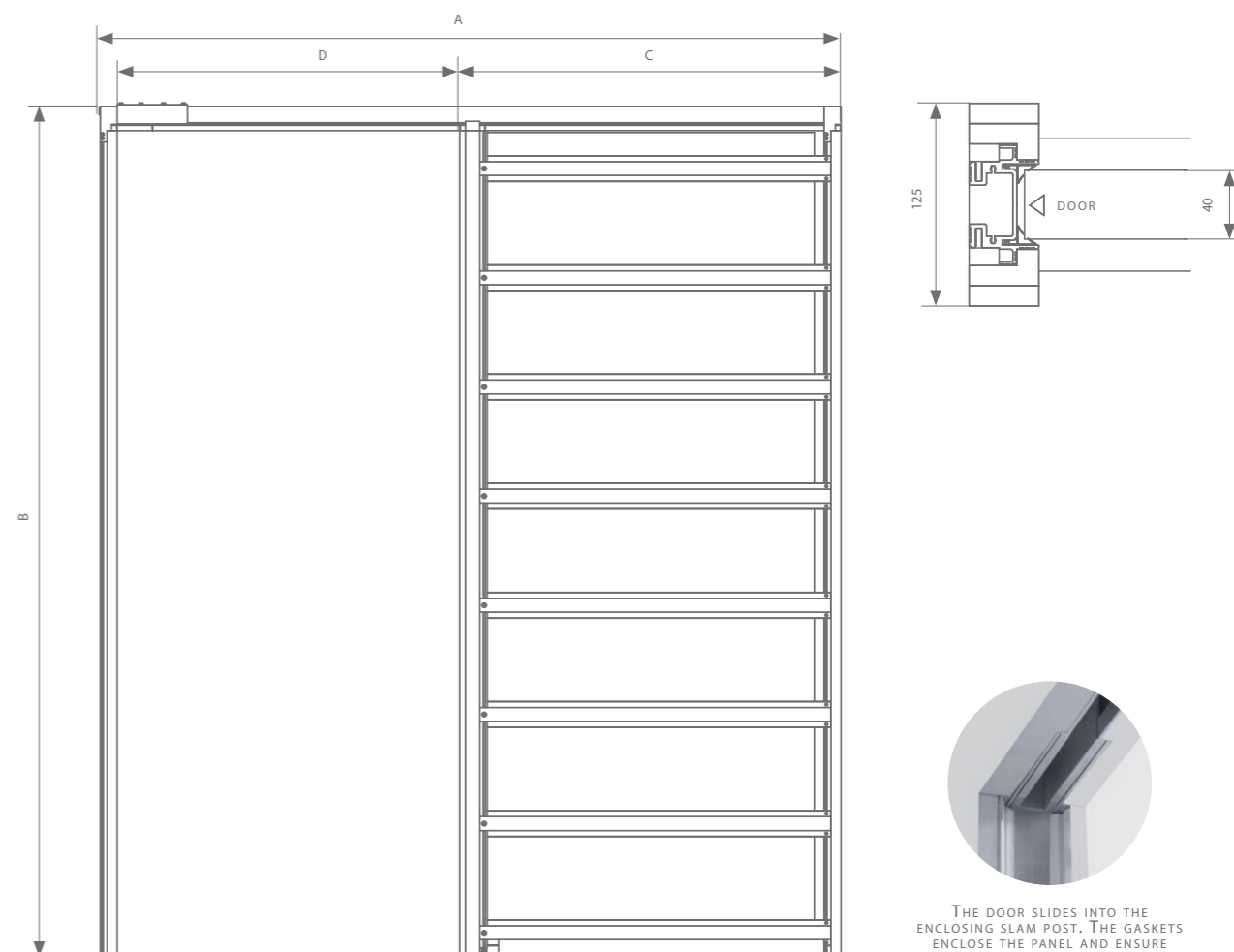

THE DOOR SLIDES INTO THE ENCLOSING SLAM POST. THE GASKETS ENCLOSE THE PANEL AND ENSURE THAT BOTH ROOMS ARE COMPLETELY CLOSED OFF.

Hook lock*

Brand	Reference
Hook lock AGB	80000196
Hook lock KFV	80000197

Each fitting set comes with all the rollers or soft-close mechanisms, suspension, guiding systems, and stoppers you need.

*Version C cannot be used for hook locks. In Version D, the slam post is equipped with milled notches and a lock housing. With this version, a hook lock of your choice is required.

** The stopper in the cavity can be replaced with an auto-eject (BC9.660) (see p.66) so the door can be hidden completely in the wall. A slight push on the side of the door brings it back into a position to be closed.

Bundles

Primer	A x B : Recessed installation dimensions	C : Casing Width	D x E : Clear passage	Wooden door panel
BC0.214.073.A2	3001 x 2113	801	1400 x 2030	730 x 2015
BC0.214.083.A2	3401 x 2113	901	1600 x 2030	830 x 2015
BC0.214.093.A2	3801 x 2113	1001	1800 x 2030	930 x 2015
BC0.214.103.A2	4201 x 2113	1101	2000 x 2030	1030 x 2015
BC0.214.113.A2	4601 x 2113	1201	2200 x 2030	1130 x 2015
BC0.214.123.A2	5001 x 2113	1301	2400 x 2030	1230 x 2040
BC0.224.073.A2	3001 x 2138	801	1400 x 2055	730 x 2040
BC0.224.083.A2	3401 x 2138	901	1600 x 2055	830 x 2040
BC0.224.093.A2	3801 x 2138	1001	1800 x 2055	930 x 2040
BC0.224.103.A2	4201 x 2138	1101	2000 x 2055	1030 x 2040
BC0.224.113.A2	4601 x 2138	1201	2200 x 2055	1130 x 2040
BC0.224.123.A2	5001 x 2138	1301	2400 x 2055	1230 x 2040
BC0.234.073.A2	3001 x 2213	801	1400 x 2130	730 x 2115
BC0.234.083.A2	3401 x 2213	901	1600 x 2130	830 x 2115
BC0.234.093.A2	3801 x 2213	1001	1800 x 2130	930 x 2115
BC0.234.103.A2	4201 x 2213	1101	2000 x 2130	1030 x 2115
BC0.234.113.A2	4601 x 2213	1201	2200 x 2130	1130 x 2115
BC0.234.123.A2	5001 x 2213	1301	2400 x 2130	1230 x 2115
BC0.244.073.A2	3001 x 2413	801	1400 x 2330	730 x 2315
BC0.244.083.A2	3401 x 2413	901	1600 x 2330	830 x 2315
BC0.244.093.A2	3801 x 2413	1001	1800 x 2330	930 x 2315
BC0.244.103.A2	4201 x 2413	1101	2000 x 2330	1030 x 2315
BC0.244.113.A2	4601 x 2413	1201	2200 x 2330	1130 x 2315
BC0.244.123.A2	5001 x 2413	1301	2400 x 2330	1230 x 2315
BC0.264.073.A2	3001 x 2883	801	1400 x 2800	730 x 2785
BC0.264.083.A2	3401 x 2883	901	1600 x 2800	830 x 2785
BC0.264.093.A2	3801 x 2883	1001	1800 x 2800	930 x 2785
BC0.264.103.A2	4201 x 2883	1101	2000 x 2800	1030 x 2785
BC0.264.113.A2	4601 x 2883	1201	2200 x 2800	1130 x 2785
BC0.264.123.A2	5001 x 2883	1301	2400 x 2800	1230 x 2785

Accessories selection

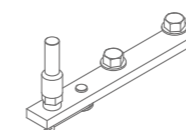

Compact suspension	Superior
Without softclose	BC0.801
With 1 softclose (min. door width = 600 mm)*	BC0.801.020

Technical drawings

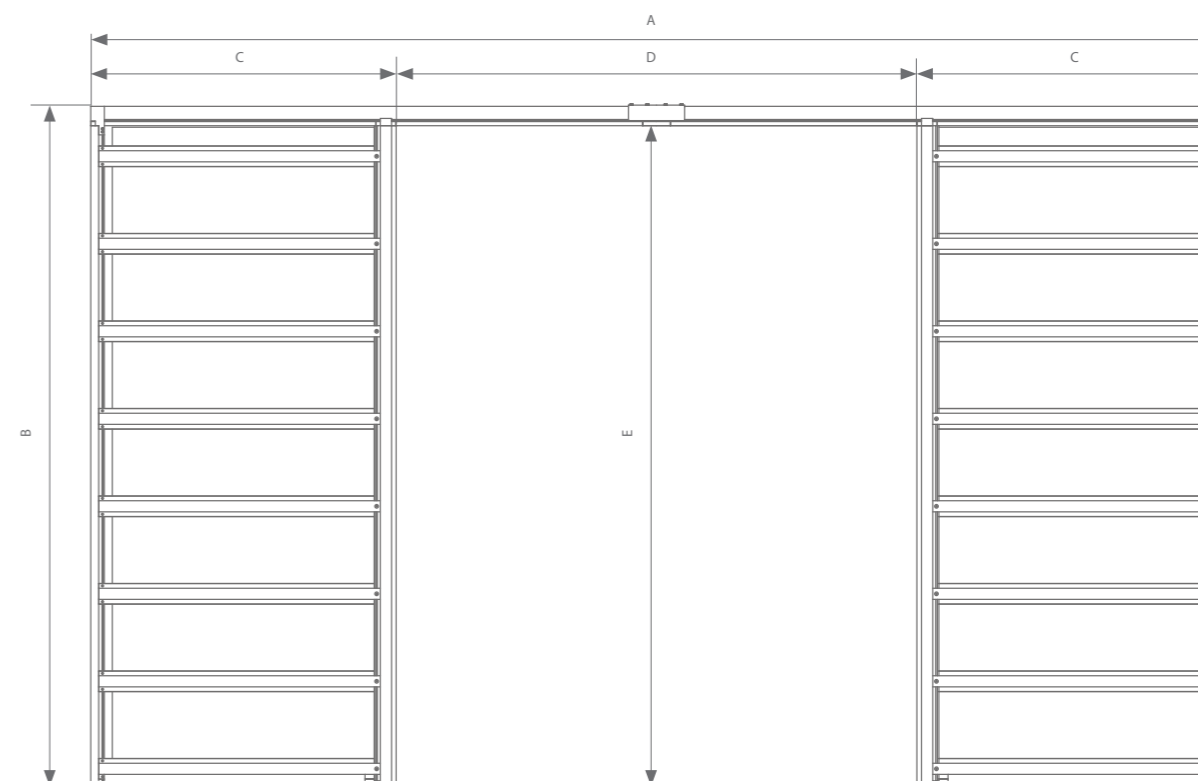

Each fitting set comes with all the rollers or soft-close mechanisms, suspension, guiding systems, and stoppers you need.

*The stopper in the cavity can be replaced with an auto-eject (BC9.660) (see p.66) so the door can be hidden completely in the wall. A slight push on the side of the door brings it back into a position to be closed.



Ter Vlucht 2 +32 (0)51 27 05 00
8850 Ardoorie info@arlu.be
Belgium WWW.ARLU.BE



©L300038 04/24 English