



XPERTA



 **argenta**

OPENING DOORS



ARLU, THE REFERENCE FOR OPENING DOORS

ARLU® is the manufacturer behind the brand names argenta® and rob®. Argenta has been a leading brand in door hardware for over 100 years, but today it is mainly synonymous with invisible door systems.

Minimalist architecture swears by clean lines and a “back to the essence” mentality. In terms of interior doors, this results in integrated door fittings, invisible integrated techniques, door frames and skirting boards for swing, sliding and pivoting doors

Argenta stands for a full range of sleek interior solutions.

ALL TECHNICAL DRAWINGS ARE SHOWN IN MILLIMETRES AND ARE SUBJECT TO CHANGE BY ARLU.

01 WOOD

- 6** SINGLE DOOR
- 8** ceiling mount
- 12** compact ceiling mount
- 14** wall mount without skirting
- 18** wall mount without skirting with brackets
- 22** compact wall mount without skirting
- 24** wall mount with skirting
- 26** wall mount with skirting and brackets
- 28** compact wall mount with skirting
- 30** autoclose
- 32** FLUSH INTO CEILING
- 36** SYMMETRIC
- 38** ceiling mount
- 42** wall mount without skirting
- 46** wall mount without skirting with brackets
- 50** wall mount with skirting
- 52** wall mount with skirting and brackets
- 54** TELESCOPIC
- 56** dual telescopic ceiling mount
- 58** dual parallel ceiling mount
- 60** compact dual parallel ceiling mount
- 62** triple telescopic ceiling mount
- 64** triple parallel ceiling mount
- 66** compact triple parallel ceiling mount
- 68** MOTORISATION

02 GLASS

- 72** SINGLE DOOR
- 74** ceiling mount
- 76** wall mount
- 78** FLUSH INTO CEILING

01

XPERTA WOOD

ARLU® is a specialist in sliding door systems, known for its expert and proslide ranges. As pioneers, we have a strong focus on development and continuous improvement. With Xperta, ARLU is taking the next step in its mission to make a difference in many interiors. The products and solutions evolve in line with the challenging international hardware market, offering many benefits for architects, carpenters and interior fitters. The unique double action softclose, silent wheels and compact suspension are just a few of the advantages of the new range.

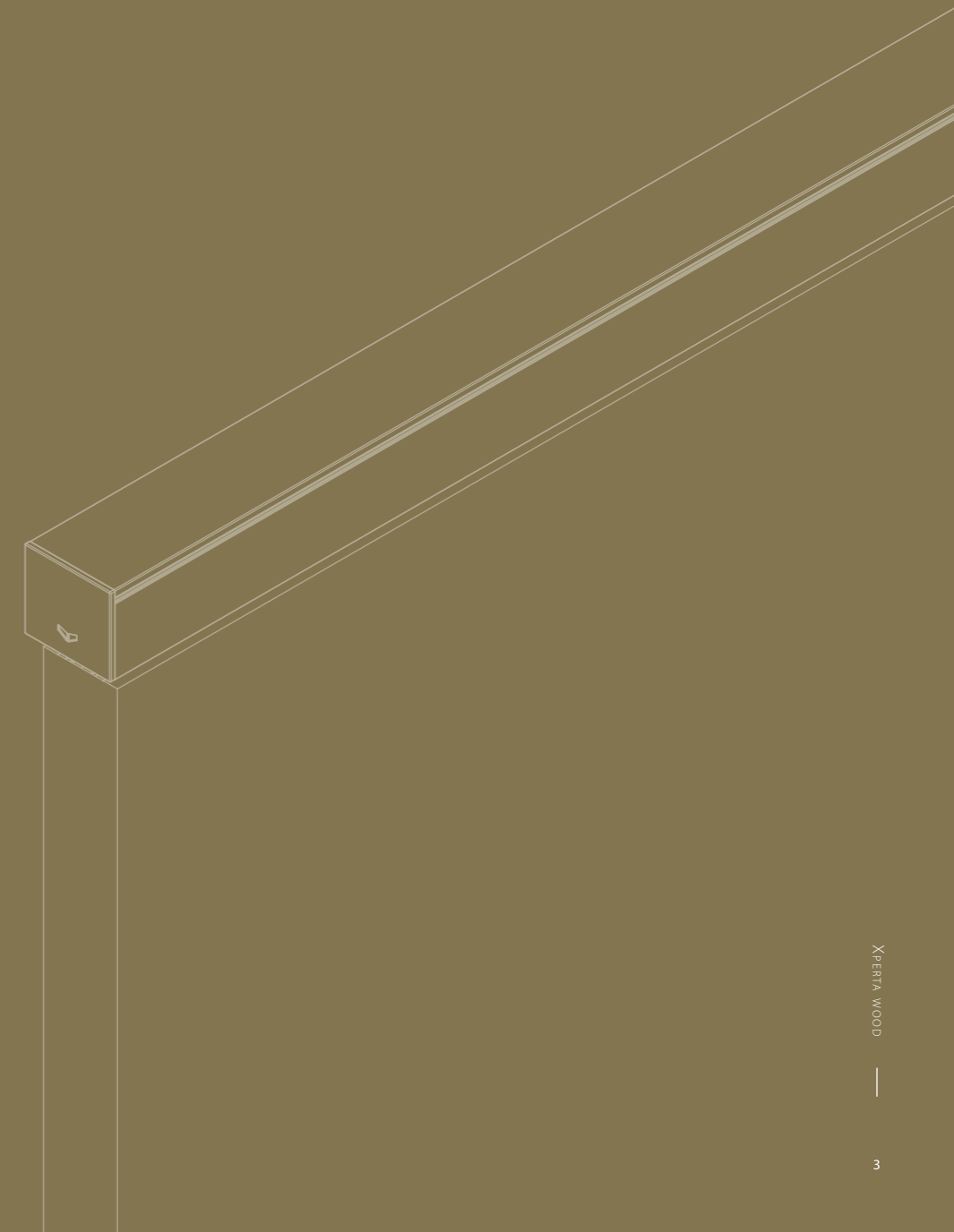

argenta Xperta wood
why choose Xperta?

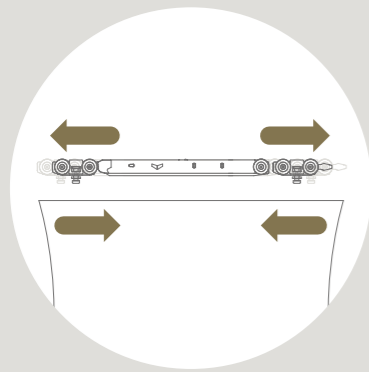

**DOUBLE-ACTION
SOFTCLOSE**

for gentle opening and closing of doors. The compact design makes it suitable for extremely narrow doors.

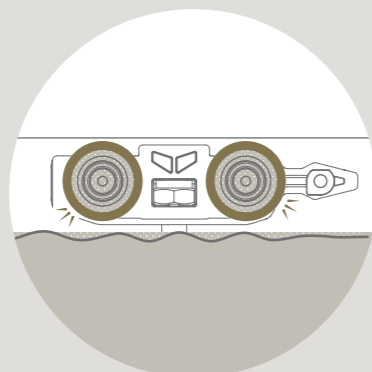

**MINIMUM ROLLING
RESISTANCE,
MAXIMUM NOISE
REDUCTION**

thanks to wheels with a hard running surface and soft core.

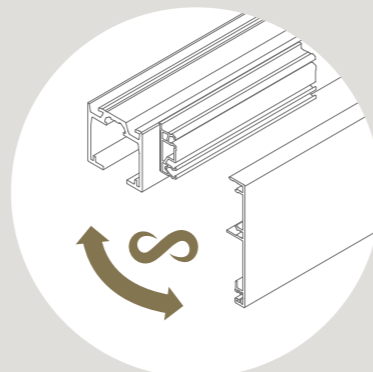

**UNIVERSAL COVER
PROFILE AND
RUNNING TRACK**

for every installation. Quick assembly thanks to unique mounting clips.

Choice of narrow or wide wall profile

Quick (dis)assembly thanks to the ESSI® module

Separate activator channel

TIP



You can use connection piece AAA.11011000.00 to connect two profiles in line.

Easy clip-in system

TIP



The AAA.25100000.07 guide is ideal in situations where you prefer not to fix the guiding channel to the floor.

4 mm

**ONLY 4 MM
CLEARANCE**
between door and running track when using auto-fix or manual-fix.

Xperta is a universal solution for wooden doors up to 100 kg. The unique running track and silent rollers ensure optimal movement of every sliding door. Xperta can be mounted with matching wall and cover profiles, or with the running track directly under the ceiling.

The Xperta invisible running track allows for an even sleeker finish in a suspended ceiling.

Bottom guiding track

Available in three colours
F1 anodised aluminium, black
and white textured coating





Xperta 100 kg **SINGLE DOOR**

Xperta sliding doors stand out for their quiet operation, versatility, intuitive installation, sleek design and durability. The unique double-action softclose ensures a comfortable use of the sliding door. The compact suspension with auto-fix, combined with the slim running and wall profiles, guarantee a quick installation with a minimalistic result.

PROFILE LENGTH

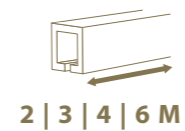

2 | 3 | 4 | 6 M

INSTALLATION



DOOR WEIGHT



MAX.
100
KG



anodised aluminium

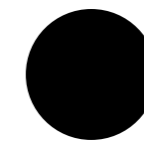

black textured coating
RAL 9005



white textured coating
RAL 9016

Technical drawings

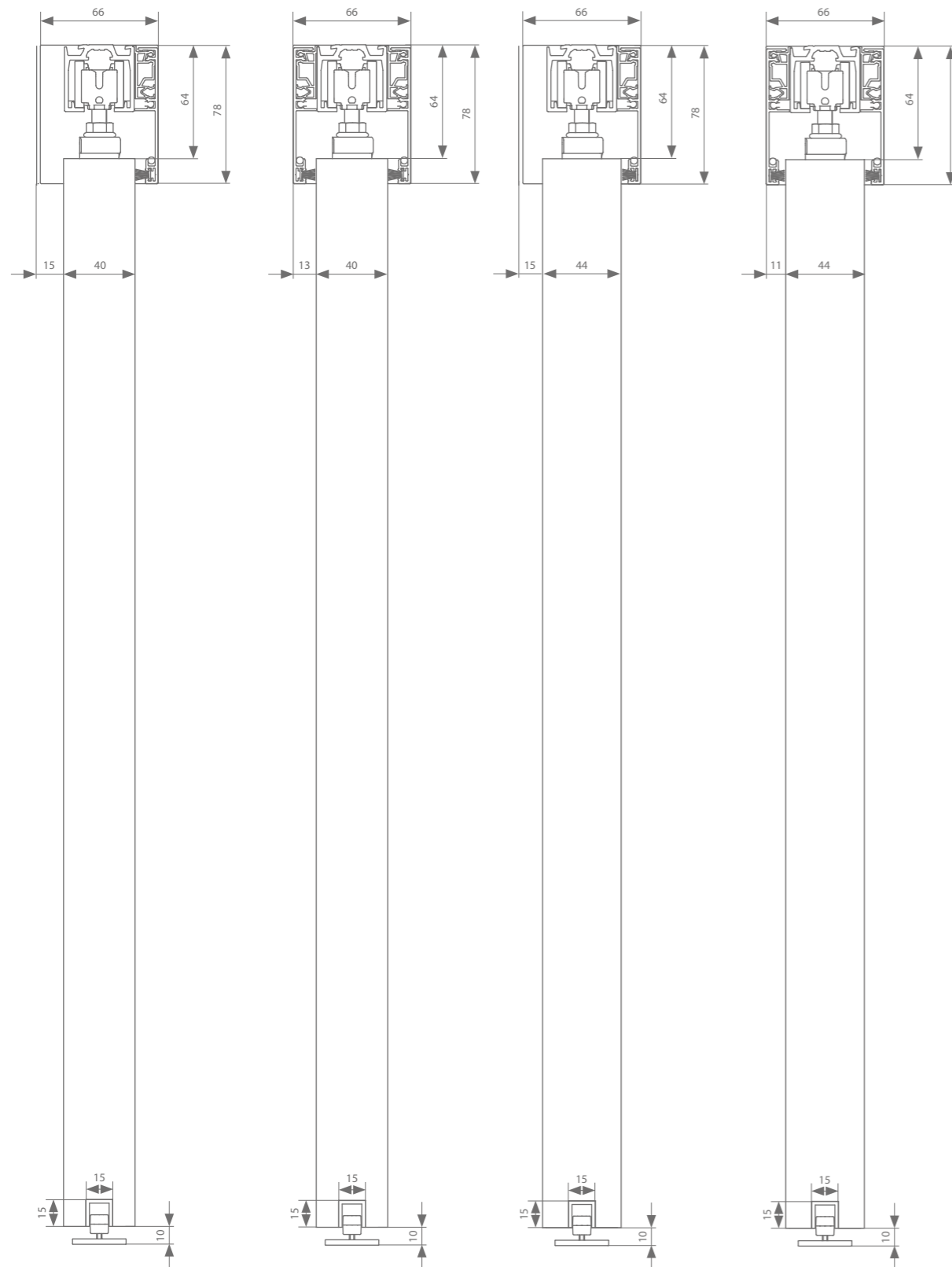

Ceiling mount 40 mm

Ceiling mount 44 mm



Height adjustment: + - 4 mm

Profiles

	Max. door width	Length			
Running track	1000 mm	2000 mm	AAA.11000200.02	AAA.11000200.07	AAA.11000200.05
	1500 mm	3000 mm	AAA.11000300.02	AAA.11000300.07	AAA.11000300.05
	2000 mm	4000 mm	AAA.11000400.02	AAA.11000400.07	AAA.11000400.05
	3000 mm	6000 mm	AAA.11000600.02	AAA.11000600.07	AAA.11000600.05
ESSI®-module (optional)		100 mm	AAA.11010010.02	AAA.11010010.07	AAA.11010010.05
Cover profile	1000 mm	2000 mm	AAA.12000200.02	AAA.12000200.07	AAA.12000200.05
	1500 mm	3000 mm	AAA.12000300.02	AAA.12000300.07	AAA.12000300.05
	2000 mm	4000 mm	AAA.12000400.02	AAA.12000400.07	AAA.12000400.05
	3000 mm	6000 mm	AAA.12000600.02	AAA.12000600.07	AAA.12000600.05
+ narrow clips 1 per metre of cover profile		100 mm		AAA.12010010.07	
Set of end caps			AAA.92020000.02	AAA.92020000.07	AAA.92020000.05
Seal	1000 mm	2000 mm	AAA.12010200.02	AAA.12010200.07	
	1500 mm	3000 mm	AAA.12010300.02	AAA.12010300.07	
	2000 mm	4000 mm	AAA.12010400.02	AAA.12010400.07	
	3000 mm	6000 mm	AAA.12010600.02	AAA.12010600.07	
Bottom guiding track	1000 mm	1000 mm	AAA.15000100.00		
	1250 mm	1250 mm	AAA.15000125.00		
	1500 mm	1500 mm	AAA.15000150.00		
	2000 mm	2000 mm	AAA.15000200.00		
	3000 mm	3000 mm	AAA.15000300.00		
	6000 mm	6000 mm	AAA.15000600.00		

Fittings selection

	Transverse suspension	Min. door width	Min. door width ESSI	Reference
	With 2 stoppers	352 mm	437 mm	AAA.20000000.00
	With double-action softclose	580 mm	664 mm	AAA.20020000.00

Motorised set*

Transverse suspension with motor	Min. door width	Min. door width ESSI	Length	Reference
Fittings	A-slide**	702 mm	794 mm	AAA.20030000.00
Belt	Min. belt length = (4 x door width) + 200 mm		50 m	AK9.709.050
			20 m	AK9.709.020
			10 m	AK9.709.010
Remote control	for 1 channel			AM3.100.104.61
	for 4 channels			AM3.100.104.64

* see p.68 for more information

** For matching end caps and clips, see p. 11.

Every fitting set comes with all the rollers or softclose mechanisms, suspension, guiding systems and stoppers you need.

Technical drawings

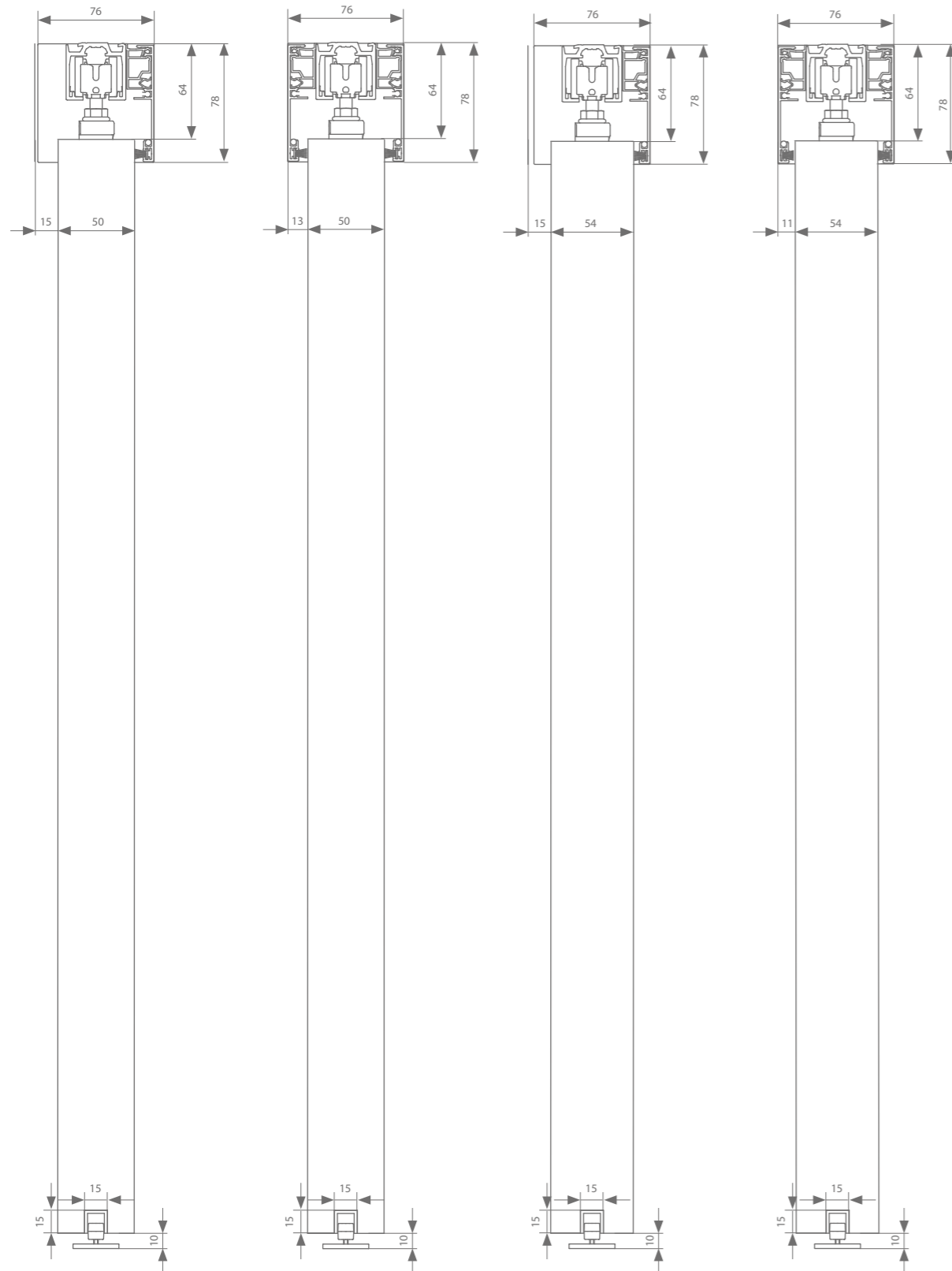

Ceiling mount 50 mm

Ceiling mount 54 mm



Height adjustment: + - 4 mm

Profiles

	Max. door width	Length			
Running track	1000 mm	2000 mm	AAA.11000200.02	AAA.11000200.07	AAA.11000200.05
	1500 mm	3000 mm	AAA.11000300.02	AAA.11000300.07	AAA.11000300.05
	2000 mm	4000 mm	AAA.11000400.02	AAA.11000400.07	AAA.11000400.05
	3000 mm	6000 mm	AAA.11000600.02	AAA.11000600.07	AAA.11000600.05
ESSI®-module (optional)		100 mm	AAA.11010010.02	AAA.11010010.07	AAA.11010010.05
Cover profile	1000 mm	2000 mm	AAA.12000200.02	AAA.12000200.07	AAA.12000200.05
	1500 mm	3000 mm	AAA.12000300.02	AAA.12000300.07	AAA.12000300.05
	2000 mm	4000 mm	AAA.12000400.02	AAA.12000400.07	AAA.12000400.05
	3000 mm	6000 mm	AAA.12000600.02	AAA.12000600.07	AAA.12000600.05
+ wide clips 1 per metre of cover profile		100 mm		AAA.12020010.07	AAA.12020100.07
Set of end caps			AAA.92040000.02	AAA.92040000.07	AAA.92040000.05
Seal	1000 mm	2000 mm	AAA.12010200.02	AAA.12010200.07	
	1500 mm	3000 mm	AAA.12010300.02	AAA.12010300.07	
	2000 mm	4000 mm	AAA.12010400.02	AAA.12010400.07	
	3000 mm	6000 mm	AAA.12010600.02	AAA.12010600.07	
Bottom guiding track	1000 mm	1000 mm	AAA.15000100.00		
	1250 mm	1250 mm	AAA.15000125.00		
	1500 mm	1500 mm	AAA.15000150.00		
	2000 mm	2000 mm	AAA.15000200.00		
	3000 mm	3000 mm	AAA.15000300.00		
	6000 mm	6000 mm	AAA.15000600.00		

Fittings selection

	Transverse suspension	Min. door width	Min. door width ESSI	Reference
	With 2 stoppers	352 mm	437 mm	AAA.20000000.00
	With double-action softclose	580 mm	664 mm	AAA.20020000.00

Motorised set*

Transverse suspension with motor	Min. door width	Min. door width ESSI	Length	Reference
Fittings	A-slide	702 mm	794 mm	AAA.20030000.00
Belt	Min. belt length = (4 x door width) + 200 mm		50 m	AK9.709.050
			20 m	AK9.709.020
			10 m	AK9.709.010
Remote control	for 1 channel			AM3.100.104.61
	for 4 channels			AM3.100.104.64



* see p.68 for more information

Every fitting set comes with all the rollers or softclose mechanisms, suspension, guiding systems and stoppers you need.

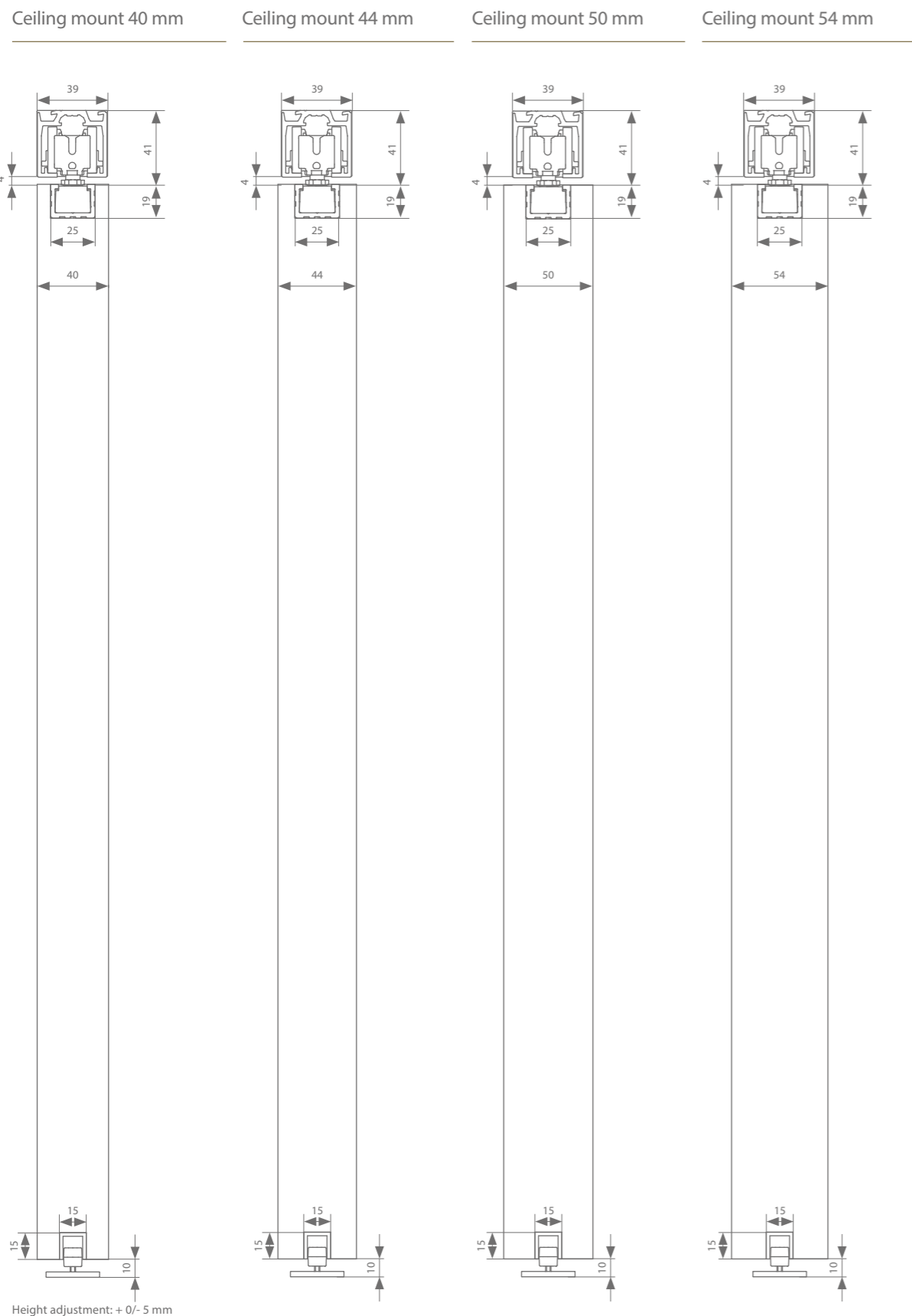
Technical drawings





Profiles

	Max. door width	Length			
Running track	1000 mm	2000 mm	AAA.11000200.02	AAA.11000200.07	AAA.11000200.05
	1500 mm	3000 mm	AAA.11000300.02	AAA.11000300.07	AAA.11000300.05
	2000 mm	4000 mm	AAA.11000400.02	AAA.11000400.07	AAA.11000400.05
	3000 mm	6000 mm	AAA.11000600.02	AAA.11000600.07	AAA.11000600.05
ESSI®-module (optional)		100 mm	AAA.11010010.02	AAA.11010010.07	AAA.11010010.05
Set of end caps			AAA.91000000.02	AAA.91000000.07	AAA.91000000.05
Suspension profile (optional)		248 mm*	AAA.14000025.00 (2 x)		
	1000mm	1000mm	AAA.14000100.00		
	1250mm	1250mm	AAA.14000125.00		
	1500mm	1500mm	AAA.14000150.00		
	2000mm	2000mm	AAA.14000200.00		
	3000mm	3000mm	AAA.14000300.00		
	6000mm	6000mm	AAA.14000600.00		
End cap suspension profile (optional)			AAA.94000000.02	AAA.94000000.07	AAA.94000000.05
Bottom guiding track	1000 mm	1000 mm	AAA.15000100.00		
	1250 mm	1250 mm	AAA.15000125.00		
	1500 mm	1500 mm	AAA.15000150.00		
	2000 mm	2000 mm	AAA.15000200.00		
	3000 mm	3000 mm	AAA.15000300.00		
	6000 mm	6000 mm	AAA.15000600.00		

* cannot be combined with ESSI®

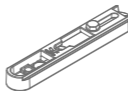
Fittings selection

	Compact suspension	Min. door width	Min. door width ESSI	Reference
	With 2 stoppers	357 mm	443 mm	AAA.20100000.00
	Double-action softclose	590 mm	664 mm	AAA.20120000.00
	With 2 stoppers	357 mm	443 mm	AAA.20200000.00
	Double-action softclose	590 mm	664 mm	AAA.20220000.00

Every fitting set comes with all the rollers or softclose mechanisms, suspension, guiding systems and stoppers you need.

argenta Xperta wood
wall mount 40/44 mm without skirting

Technical drawings

Wall mount 40 mm

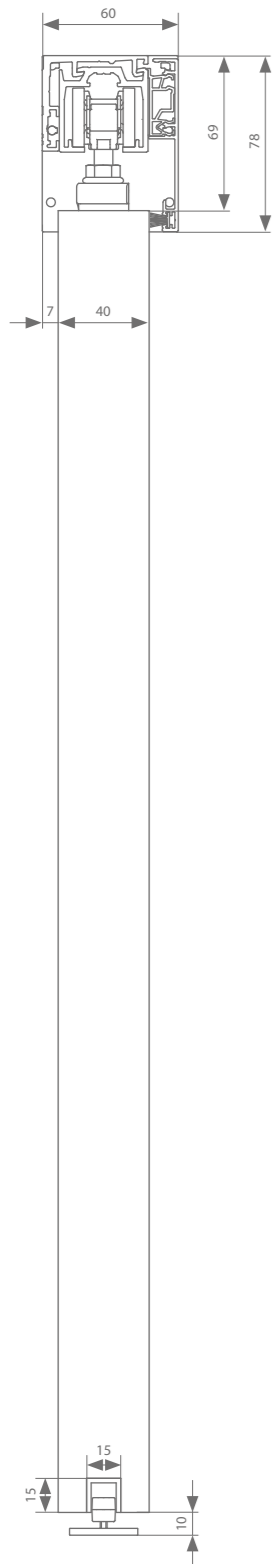

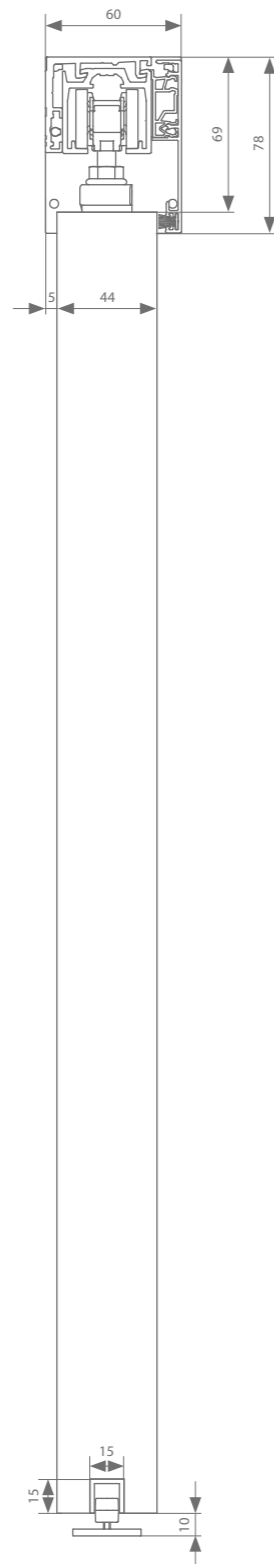

Wall mount 44 mm



Height adjustment: + - 4 mm

Profiles

assemble your set 

	Max. door width	Length			
Running track	1000 mm	2000 mm	AAA.11000200.02	AAA.11000200.07	AAA.11000200.05
	1500 mm	3000 mm	AAA.11000300.02	AAA.11000300.07	AAA.11000300.05
	2000 mm	4000 mm	AAA.11000400.02	AAA.11000400.07	AAA.11000400.05
	3000 mm	6000 mm	AAA.11000600.02	AAA.11000600.07	AAA.11000600.05
ESSI®-module (optional)		100 mm	AAA.11010010.02	AAA.11010010.07	AAA.11010010.05
Wall profile	1000 mm	2000 mm	AAA.13000200.02	AAA.13000200.07	AAA.13000200.05
	1500 mm	3000 mm	AAA.13000300.02	AAA.13000300.07	AAA.13000300.05
	2000 mm	4000 mm	AAA.13000400.02	AAA.13000400.07	AAA.13000400.05
	3000 mm	6000 mm	AAA.13000600.02	AAA.13000600.07	AAA.13000600.05
+ mounting set		1 per 3 m		AAA.13010000.07	
Cover profile	1000 mm	2000 mm	AAA.12000200.02	AAA.12000200.07	AAA.12000200.05
	1500 mm	3000 mm	AAA.12000300.02	AAA.12000300.07	AAA.12000300.05
	2000 mm	4000 mm	AAA.12000400.02	AAA.12000400.07	AAA.12000400.05
	3000 mm	6000 mm	AAA.12000600.02	AAA.12000600.07	AAA.12000600.05
+ narrow clips 1 per metre of cover profile		100 mm		AAA.12010010.07	
Set of end caps			AAA.92000000.02	AAA.92000000.07	AAA.92000000.05
Seal	1000 mm	2000 mm	AAA.12010200.02	AAA.12010200.07	
	1500 mm	3000 mm	AAA.12010300.02	AAA.12010300.07	
	2000 mm	4000 mm	AAA.12010400.02	AAA.12010400.07	
	3000 mm	6000 mm	AAA.12010600.02	AAA.12010600.07	
Bottom guiding track	1000 mm	1000 mm	AAA.15000100.00		
	1250 mm	1250 mm	AAA.15000125.00		
	1500 mm	1500 mm	AAA.15000150.00		
	2000 mm	2000 mm	AAA.15000200.00		
	3000 mm	3000 mm	AAA.15000300.00		
	6000 mm	6000 mm	AAA.15000600.00		

Fittings selection

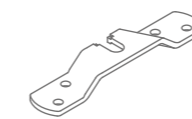



Transverse suspension	Min. door width	Min. door width ESSI	Reference
With 2 stoppers	352 mm	437 mm	AAA.20000000.00
With double-action softclose	580 mm	664 mm	AAA.20020000.00

Motorised set*

Transverse suspension with motor	Min. door width	Min. door width ESSI	Length	Reference
Fittings	A-slide**	702 mm	794 mm	AAA.20030000.00
Belt	Min. belt length = (4 x door width) + 200 mm		50 m	AK9.709.050
			20 m	AK9.709.020
			10 m	AK9.709.010
Remote control	for 1 channel			AM3.100.104.61
	for 4 channels			AM3.100.104.64

Every fitting set comes with all the rollers or softclose mechanisms, suspension, guiding systems and stoppers you need.

Complete sets

	Max. door width	Length			
With 2 stoppers	1000 mm	2000 mm	AAA.32000200.02	AAA.32000200.07	AAA.32000200.05
Double-action softclose	1000 mm	2000 mm	AAA.32002200.02	AAA.32002200.07	AAA.32002200.05

* see p.68 for more information

** Cannot be combined with cover profiles and end caps

argenta Xperta wood
wall mount 50/54 mm without skirting

Technical drawings

Wall mount 50 mm

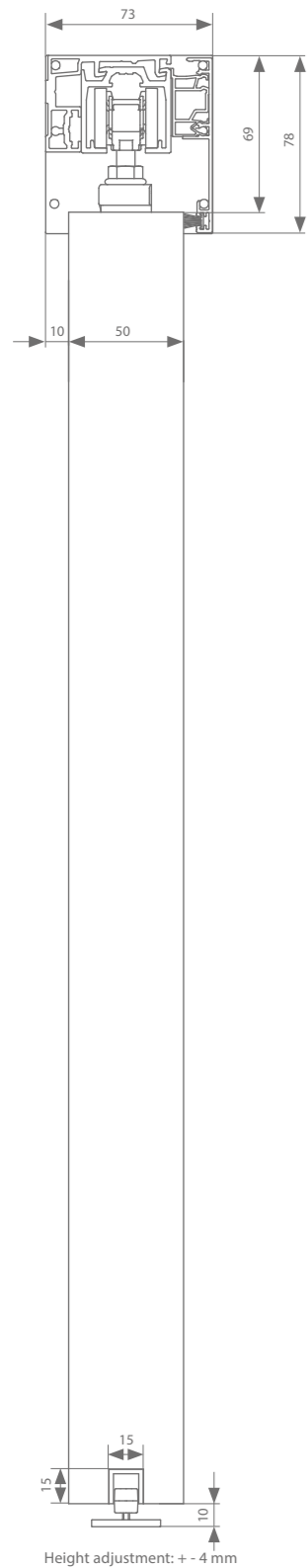

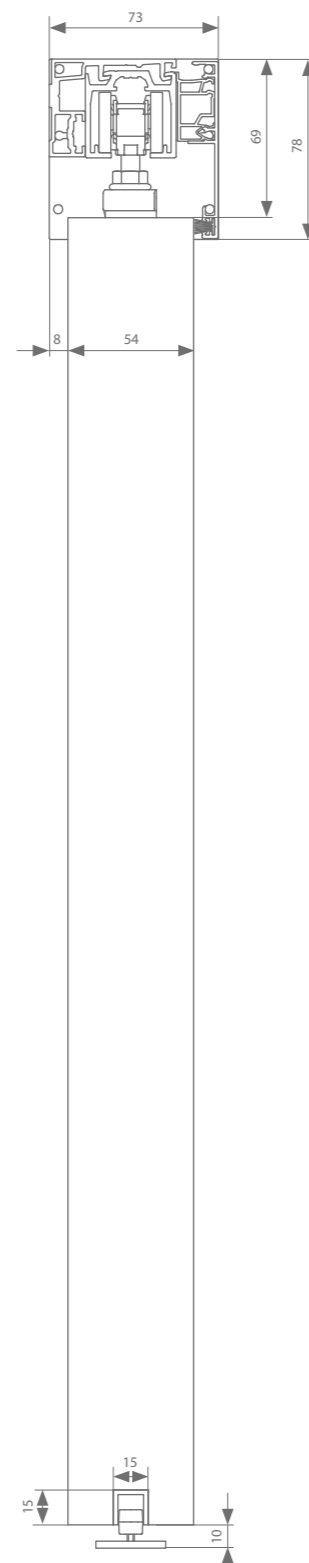

Wall mount 54 mm



Profiles

assemble your set 

	Max. door width	Length			
Running track	1000 mm	2000 mm	AAA.11000200.02	AAA.11000200.07	AAA.11000200.05
	1500 mm	3000 mm	AAA.11000300.02	AAA.11000300.07	AAA.11000300.05
	2000 mm	4000 mm	AAA.11000400.02	AAA.11000400.07	AAA.11000400.05
	3000 mm	6000 mm	AAA.11000600.02	AAA.11000600.07	AAA.11000600.05
ESSI®-module (optional)		100 mm	AAA.11010010.02	AAA.11010010.07	AAA.11010010.05
Wall profile	1000 mm	2000 mm	AAA.13100200.02	AAA.13100200.07	AAA.13100200.05
	1500 mm	3000 mm	AAA.13100300.02	AAA.13100300.07	AAA.13100300.05
	2000 mm	4000 mm	AAA.13100400.02	AAA.13100400.07	AAA.13100400.05
	3000 mm	6000 mm	AAA.13100600.02	AAA.13100600.07	AAA.13100600.05
+ mounting set		1 per 3 m		AAA.13010000.07	
Cover profile	1000 mm	2000 mm	AAA.12000200.02	AAA.12000200.07	AAA.12000200.05
	1500 mm	3000 mm	AAA.12000300.02	AAA.12000300.07	AAA.12000300.05
	2000 mm	4000 mm	AAA.12000400.02	AAA.12000400.07	AAA.12000400.05
	3000 mm	6000 mm	AAA.12000600.02	AAA.12000600.07	AAA.12000600.05
+ wide clips 1 per metre of cover profile		100 mm 1000 mm		AAA.12020010.07 AAA.12020100.07	
Set of end caps			AAA.92030000.02	AAA.92030000.07	AAA.92030000.05
Seal	1000 mm	2000 mm	AAA.12010200.02	AAA.12010200.07	
	1500 mm	3000 mm	AAA.12010300.02	AAA.12010300.07	
	2000 mm	4000 mm	AAA.12010400.02	AAA.12010400.07	
	3000 mm	6000 mm	AAA.12010600.02	AAA.12010600.07	
Bottom guiding track	1000 mm	1000 mm	AAA.15000100.00		
	1250 mm	1250 mm	AAA.15000125.00		
	1500 mm	1500 mm	AAA.15000150.00		
	2000 mm	2000 mm	AAA.15000200.00		
	3000 mm	3000 mm	AAA.15000300.00		
	6000 mm	6000 mm	AAA.15000600.00		

Fittings selection

	Transverse suspension	Min. door width	Min. door width ESSI	Reference
	With 2 stoppers	352 mm	437 mm	AAA.20000000.00
	With double-action softclose	580 mm	664 mm	AAA.20020000.00

Motorised set*

Transverse suspension with motor	Min. door width	Min. door width ESSI	Length	Reference
Fittings	A-slide	702 mm	794 mm	AAA.20030000.00
Belt	Min. belt length = (4 x door width) + 200 mm		50 m	AK9.709.050
			20 m	AK9.709.020
			10 m	AK9.709.010
Remote control	for 1 channel			AM3.100.104.61
	for 4 channels			AM3.100.104.64

* see p.68 for more information

Every fitting set comes with all the rollers or softclose mechanisms, suspension, guiding systems and stoppers you need.

Technical drawings

Wall mount 40 mm

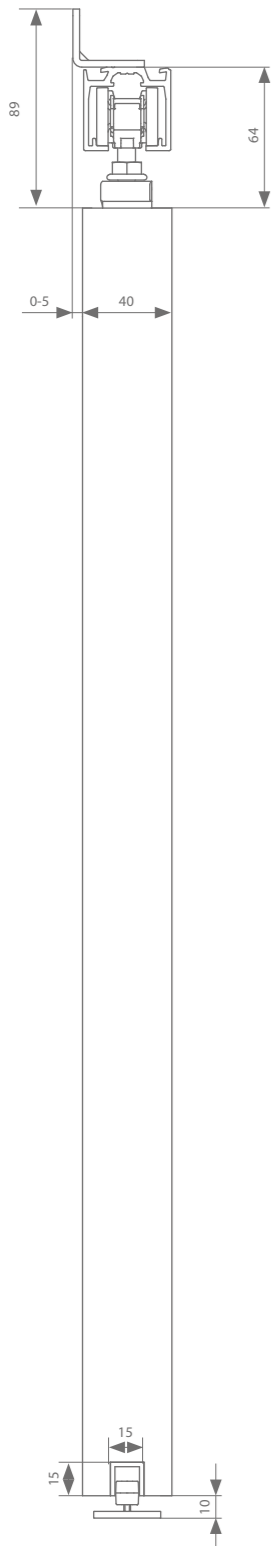

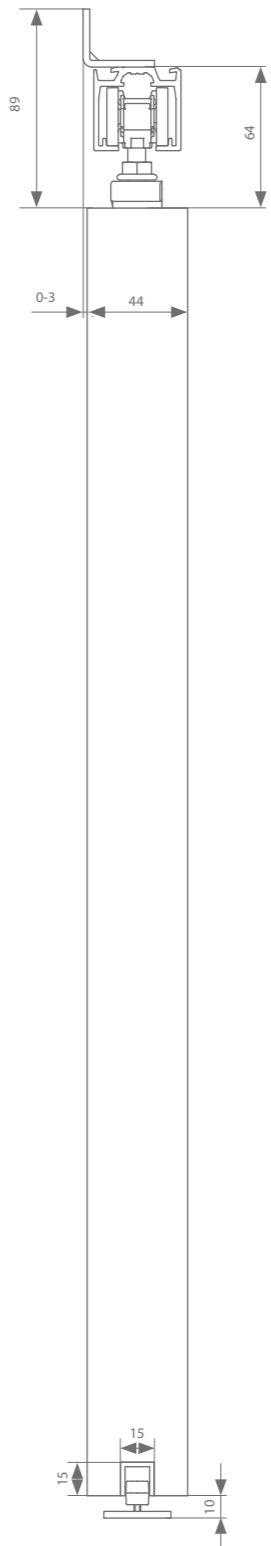

Wall mount 44 mm



Height adjustment: + - 4 mm

Profiles

	Max. door width	Length			
Running track	1000 mm	2000 mm	AAA.11000200.02	AAA.11000200.07	AAA.11000200.05
	1500 mm	3000 mm	AAA.11000300.02	AAA.11000300.07	AAA.11000300.05
	2000 mm	4000 mm	AAA.11000400.02	AAA.11000400.07	AAA.11000400.05
	3000 mm	6000 mm	AAA.11000600.02	AAA.11000600.07	AAA.11000600.05
ESSI®-module (optional)		100 mm	AAA.11010010.02	AAA.11010010.07	AAA.11010010.05
Wall bracket		every 500 mm needed	AAA.01000000.01		
Bottom guiding track	1000 mm	1000 mm	AAA.15000100.00		
	1250 mm	1250 mm	AAA.15000125.00		
	1500 mm	1500 mm	AAA.15000150.00		
	2000 mm	2000 mm	AAA.15000200.00		
	3000 mm	3000 mm	AAA.15000300.00		
	6000 mm	6000 mm	AAA.15000600.00		

Fittings selection

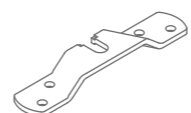
	Transverse suspension	Min. door width	Min. door width ESSI	Reference
	With 2 stoppers	352 mm	437 mm	AAA.20000000.00
	With double-action softclose	580 mm	664 mm	AAA.20020000.00

Motorised set*

	Transverse suspension with motor	Min. door width	Min. door width ESSI	Length	Reference
Fittings	A-slide	702 mm	794 mm		AAA.20030000.00
Belt	Min. belt length = (4 x door width) + 200 mm			50 m	AK9.709.050
				20 m	AK9.709.020
				10 m	AK9.709.010
Remote control	for 1 channel				AM3.100.104.61
	for 4 channels				AM3.100.104.64

* see p.68 for more information

Every fitting set comes with all the rollers or softclose mechanisms, suspension, guiding systems and stoppers you need.

Complete sets

	Max. door width	Length	
With 2 stoppers	1000 mm	2000 mm	AAA.31000200.02
With double-action softclose	1000 mm	2000 mm	AAA.31002200.02

Technical drawings

Wall mount 50 mm

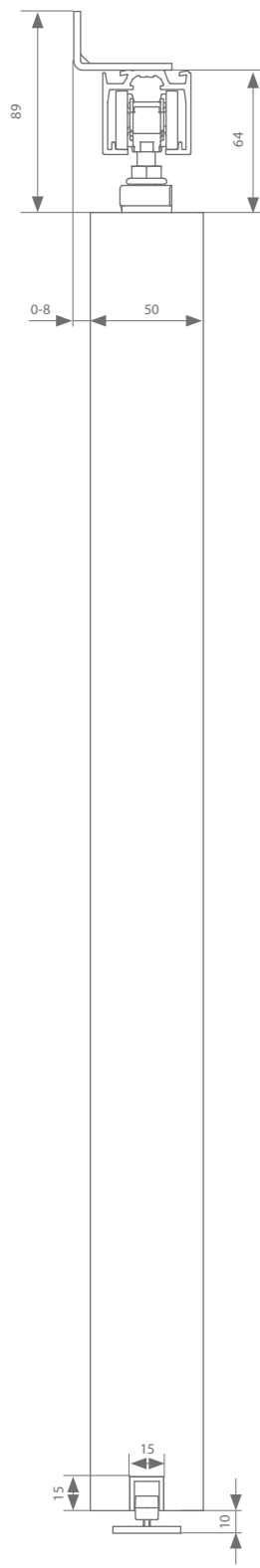

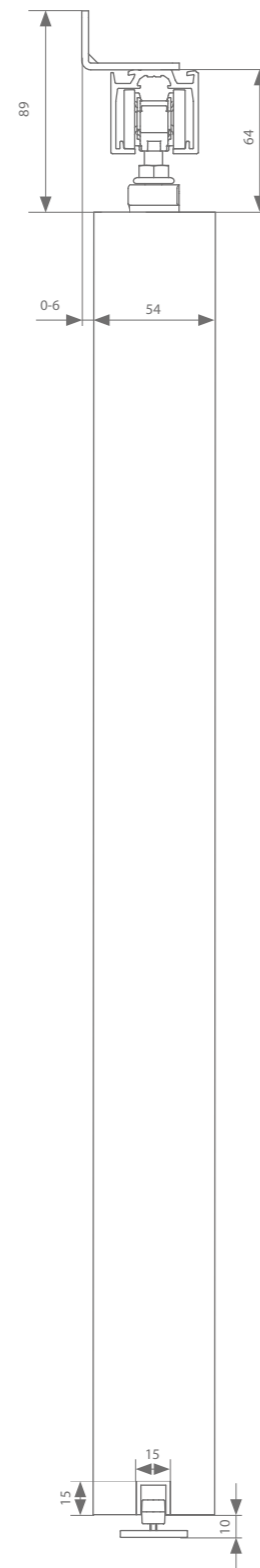

Height adjustment: + - 4 mm

Wall mount 54 mm



Profiles

	Max. door width	Length			
Running track	1000 mm	2000 mm	AAA.11000200.02	AAA.11000200.07	AAA.11000200.05
	1500 mm	3000 mm	AAA.11000300.02	AAA.11000300.07	AAA.11000300.05
	2000 mm	4000 mm	AAA.11000400.02	AAA.11000400.07	AAA.11000400.05
	3000 mm	6000 mm	AAA.11000600.02	AAA.11000600.07	AAA.11000600.05
ESSI®-module (optional)		100 mm	AAA.11010010.02	AAA.11010010.07	AAA.11010010.05
Wall bracket		every 500 mm needed	AAA.01100000.01		
Bottom guiding track	1000 mm	1000 mm	AAA.15000100.00		
	1250 mm	1250 mm	AAA.15000125.00		
	1500 mm	1500 mm	AAA.15000150.00		
	2000 mm	2000 mm	AAA.15000200.00		
	3000 mm	3000 mm	AAA.15000300.00		
	6000 mm	6000 mm	AAA.15000600.00		

Fittings selection

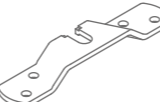

Transverse suspension	Min. door width	Min. door width ESSI	Reference
With 2 stoppers	352 mm	437 mm	AAA.20000000.00
With double-action softclose	580 mm	664 mm	AAA.20020000.00

Motorised set*

Transverse suspension with motor	Min. door width	Min. door width ESSI	Length	Reference
Fittings	A-slide	702 mm		AAA.20030000.00
Belt	Min. belt length = (4 x door width) + 200 mm		50 m	AK9.709.050
			20 m	AK9.709.020
			10 m	AK9.709.010
Remote control	for 1 channel			AM3.100.104.61
	for 4 channels			AM3.100.104.64

* see p.68 for more information

Every fitting set comes with all the rollers or softclose mechanisms, suspension, guiding systems and stoppers you need.

argenta Xperta wood
compact wall mount 40/44 mm without skirting

Technical drawings

Wall mount 40 mm

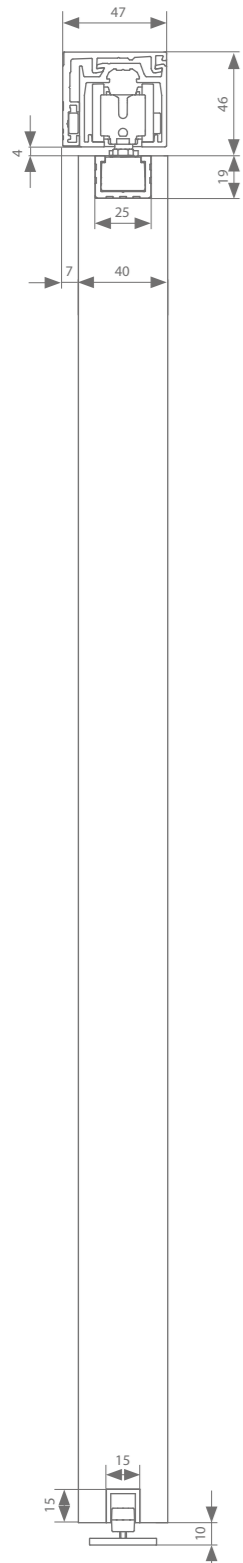

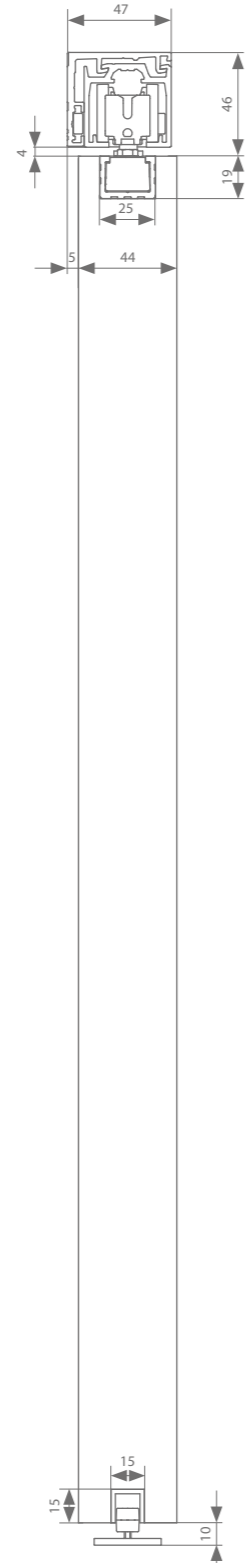

Wall mount 44 mm



Height adjustment: + 0/- 5 mm



assemble your set 

Profiles

	Max. door width	Length			
Running track	1000 mm	2000 mm	AAA.11000200.02	AAA.11000200.07	AAA.11000200.05
	1500 mm	3000 mm	AAA.11000300.02	AAA.11000300.07	AAA.11000300.05
	2000 mm	4000 mm	AAA.11000400.02	AAA.11000400.07	AAA.11000400.05
	3000 mm	6000 mm	AAA.11000600.02	AAA.11000600.07	AAA.11000600.05
ESSI®-module (optional)		100 mm	AAA.11010010.02	AAA.11010010.07	AAA.11010010.05
Wall profile	1000 mm	2000 mm	AAA.13000200.02	AAA.13000200.07	AAA.13000200.05
	1500 mm	3000 mm	AAA.13000300.02	AAA.13000300.07	AAA.13000300.05
	2000 mm	4000 mm	AAA.13000400.02	AAA.13000400.07	AAA.13000400.05
	3000 mm	6000 mm	AAA.13000600.02	AAA.13000600.07	AAA.13000600.05
+ mounting set		1 per 3 m		AAA.13010000.07	
Set of end caps			AAA.93000000.02	AAA.93000000.07	AAA.93000000.05
Suspension profile (optional)	1000 mm	248 mm*	AAA.14000025.00 (2 x)		
	1000 mm	1000 mm	AAA.14000100.00		
	1250 mm	1250 mm	AAA.14000125.00		
	1500 mm	1500 mm	AAA.14000150.00		
	2000 mm	2000 mm	AAA.14000200.00		
	3000 mm	3000 mm	AAA.14000300.00		
End cap suspension profile (optional)			AAA.94000000.02	AAA.94000000.07	AAA.94000000.05
Bottom guiding track	1000 mm	1000 mm	AAA.15000100.00		
	1250 mm	1250 mm	AAA.15000125.00		
	1500 mm	1500 mm	AAA.15000150.00		
	2000 mm	2000 mm	AAA.15000200.00		
	3000 mm	3000 mm	AAA.15000300.00		
	6000 mm	6000 mm	AAA.15000600.00		

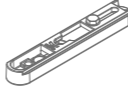

* cannot be combined with ESSI*

Fittings selection

	Compact suspension	Min. door width	Min. door width ESSI	Reference
	With 2 stoppers	357 mm	443 mm	AAA.20100000.00
	Double-action softclose	590 mm	664 mm	AAA.20120000.00
	With 2 stoppers	357 mm	443 mm	AAA.20200000.00
	Double-action softclose	590 mm	664 mm	AAA.20220000.00

Every fitting set comes with all the rollers or softclose mechanisms, suspension, guiding systems and stoppers you need.

Complete sets

	Max. door width	Length			
With 2 stoppers	1000 mm	2000 mm	AAA.33000200.02	AAA.33000200.07	AAA.33000200.05
Double-action softclose	1000 mm	2000 mm	AAA.33002200.02	AAA.33002200.07	AAA.33002200.05

argenta Xperta wood
wall mount 40/44 mm with skirting

Technical drawings

Wall mount 40 mm

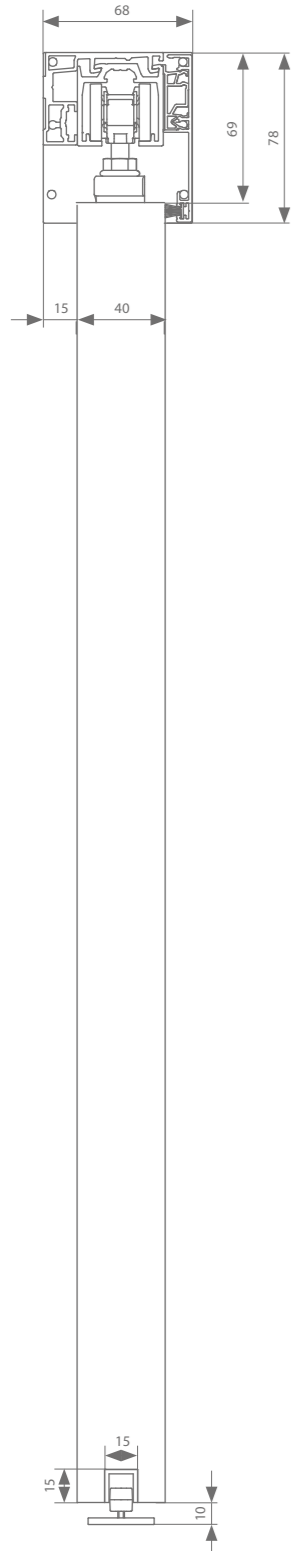

Wall mount 44 mm

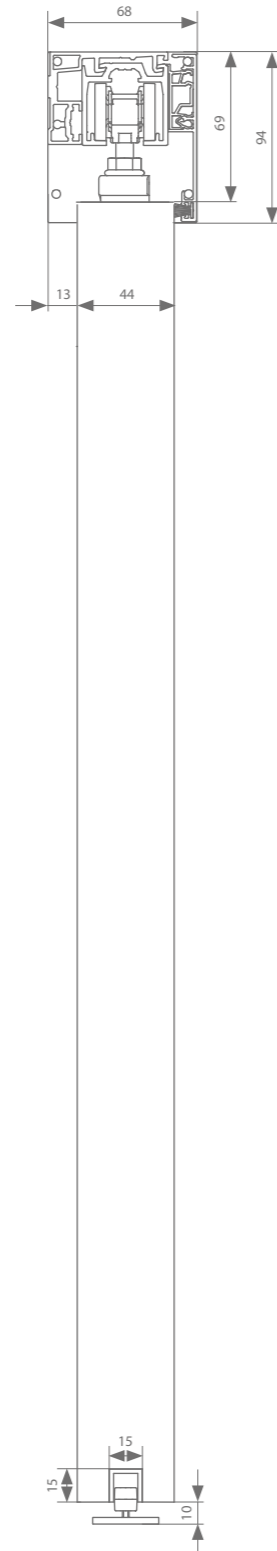

Height adjustment: + - 4 mm

Profiles

assemble your set

	Max. door width	Length			
Running track	1000 mm	2000 mm	AAA.11000200.02	AAA.11000200.07	AAA.11000200.05
	1500 mm	3000 mm	AAA.11000300.02	AAA.11000300.07	AAA.11000300.05
	2000 mm	4000 mm	AAA.11000400.02	AAA.11000400.07	AAA.11000400.05
	3000 mm	6000 mm	AAA.11000600.02	AAA.11000600.07	AAA.11000600.05
ESSI®-module (optional)		100 mm	AAA.11010010.02	AAA.11010010.07	AAA.11010010.05
Wall profile	1000 mm	2000 mm	AAA.13100200.02	AAA.13100200.07	AAA.13100200.05
	1500 mm	3000 mm	AAA.13100300.02	AAA.13100300.07	AAA.13100300.05
	2000 mm	4000 mm	AAA.13100400.02	AAA.13100400.07	AAA.13100400.05
	3000 mm	6000 mm	AAA.13100600.02	AAA.13100600.07	AAA.13100600.05
+ mounting set		1 per 3 m	AAA.13010000.07	AAA.13010000.07	
Cover profile	1000 mm	2000 mm	AAA.12000200.02	AAA.12000200.07	AAA.12000200.05
	1500 mm	3000 mm	AAA.12000300.02	AAA.12000300.07	AAA.12000300.05
	2000 mm	4000 mm	AAA.12000400.02	AAA.12000400.07	AAA.12000400.05
	3000 mm	6000 mm	AAA.12000600.02	AAA.12000600.07	AAA.12000600.05
+ narrow clips 1 per metre of cover profile		100 mm		AAA.12010010.07	
Set of end caps			AAA.92010000.02	AAA.92010000.07	AAA.92010000.05
Seal	1000 mm	2000 mm	AAA.12010200.02	AAA.12010200.07	
	1500 mm	3000 mm	AAA.12010300.02	AAA.12010300.07	
	2000 mm	4000 mm	AAA.12010400.02	AAA.12010400.07	
	3000 mm	6000 mm	AAA.12010600.02	AAA.12010600.07	
Bottom guiding track	1000 mm	1000 mm	AAA.15000100.00		
	1250 mm	1250 mm	AAA.15000125.00		
	1500 mm	1500 mm	AAA.15000150.00		
	2000 mm	2000 mm	AAA.15000200.00		
	3000 mm	3000 mm	AAA.15000300.00		
	6000 mm	6000 mm	AAA.15000600.00		

Fittings selection



Transverse suspension	Min. door width	Min. door width ESSI	Reference
With 2 stoppers	352 mm	437 mm	AAA.20000000.00
With double-action softclose	580 mm	664 mm	AAA.20020000.00

Motorised set*

Transverse suspension with motor	Min. door width	Min. door width ESSI	Length	Reference
Fittings	A-slide**	702 mm	794 mm	AAA.20030000.00
Belt	Min. belt length = (4 x door width) + 200 mm		50 m	AK9.709.050
			20 m	AK9.709.020
			10 m	AK9.709.010
Remote control	for 1 channel			AM3.100.104.61
	for 4 channels			AM3.100.104.64

Every fitting set comes with all the rollers or softclose mechanisms, suspension, guiding systems and stoppers you need.

Complete sets

	Max. door width	Length			
With 2 stoppers	1000 mm	2000 mm	AAA.32010200.02	AAA.32010200.07	AAA.32010200.05
Double-action softclose	1000 mm	2000 mm	AAA.32012200.02	AAA.32012200.07	AAA.32012200.05

* see p.68 for more information

** For matching end caps and clips, see p. 17.

Technical drawings

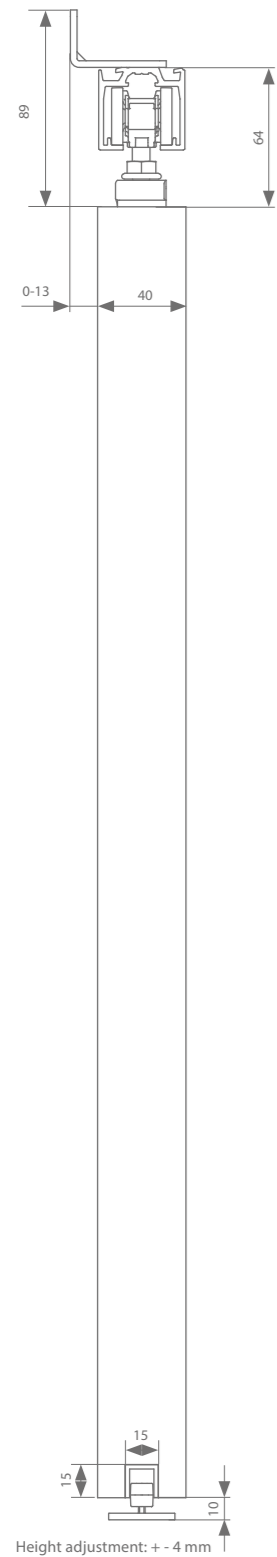

Wall mount 40 mm

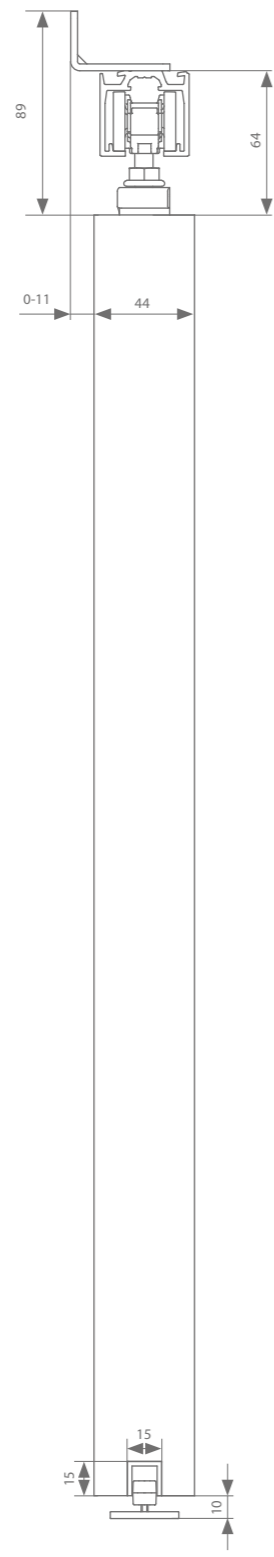

Wall mount 44 mm



Profiles

	Max. door width	Length			
Running track	1000 mm	2000 mm	AAA.11000200.02	AAA.11000200.07	AAA.11000200.05
	1500 mm	3000 mm	AAA.11000300.02	AAA.11000300.07	AAA.11000300.05
	2000 mm	4000 mm	AAA.11000400.02	AAA.11000400.07	AAA.11000400.05
	3000 mm	6000 mm	AAA.11000600.02	AAA.11000600.07	AAA.11000600.05
ESSI®-module (optional)		100 mm	AAA.11010010.02	AAA.11010010.07	AAA.11010010.05
Wall bracket		every 500 mm needed	AAA.01100000.01		
Bottom guiding track	1000 mm	1000 mm	AAA.15000100.00		
	1250 mm	1250 mm	AAA.15000125.00		
	1500 mm	1500 mm	AAA.15000150.00		
	2000 mm	2000 mm	AAA.15000200.00		
	3000 mm	3000 mm	AAA.15000300.00		
	6000 mm	6000 mm	AAA.15000600.00		

Fittings selection



Transverse suspension	Min. door width	Min. door width ESSI	Reference
With 2 stoppers	352 mm	437 mm	AAA.20000000.00
With double-action softclose	580 mm	664 mm	AAA.20020000.00

Motorised set*

Transverse suspension with motor	Min. door width	Min. door width ESSI	Length	Reference
Fittings	A-slide	702 mm		AAA.20030000.00
Belt	Min. belt length = (4 x door width) + 200 mm		50 m	AK9.709.050
			20 m	AK9.709.020
			10 m	AK9.709.010
Remote control	for 1 channel			AM3.100.104.61
	for 4 channels			AM3.100.104.64

* see p.68 for more information

Every fitting set comes with all the rollers or softclose mechanisms, suspension, guiding systems and stoppers you need.

argenta Xperta wood
compact wall mount 40/44 with skirting

Technical drawings

Wall mount 40 mm

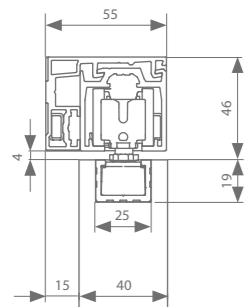

Wall mount 44 mm

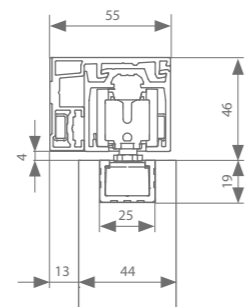

Height adjustment: + 0/- 5 mm

assemble your set

Profiles

	Max. door width	Length			
Running track	1000 mm	2000 mm	AAA.11000200.02	AAA.11000200.07	AAA.11000200.05
	1500 mm	3000 mm	AAA.11000300.02	AAA.11000300.07	AAA.11000300.05
	2000 mm	4000 mm	AAA.11000400.02	AAA.11000400.07	AAA.11000400.05
	3000 mm	6000 mm	AAA.11000600.02	AAA.11000600.07	AAA.11000600.05
ESSI®-module (optional)		100 mm	AAA.11010010.02	AAA.11010010.07	AAA.11010010.05
Wall profile	1000 mm	2000 mm	AAA.13100200.02	AAA.13100200.07	AAA.13100200.05
	1500 mm	3000 mm	AAA.13100300.02	AAA.13100300.07	AAA.13100300.05
	2000 mm	4000 mm	AAA.13100400.02	AAA.13100400.07	AAA.13100400.05
	3000 mm	6000 mm	AAA.13100600.02	AAA.13100600.07	AAA.13100600.05
+ mounting set		1 per 3 m		AAA.13010000.07	
Set of end caps			AAA.93100000.02	AAA.93100000.07	AAA.93100000.05
Suspension profile (optional)		248 mm*	AAA.14000025.00 (2 x)		
	1000 mm	1000 mm	AAA.14000100.00		
	1250 mm	1250 mm	AAA.14000125.00		
	1500 mm	1500 mm	AAA.14000150.00		
	2000 mm	2000 mm	AAA.14000200.00		
	3000 mm	3000 mm	AAA.14000300.00		
6000 mm	6000 mm	AAA.14000600.00			
End cap suspension profile (optional)			AAA.94000000.02	AAA.94000000.07	AAA.94000000.05
Bottom guiding track	1000 mm	1000 mm	AAA.15000100.00		
	1250 mm	1250 mm	AAA.15000125.00		
	1500 mm	1500 mm	AAA.15000150.00		
	2000 mm	2000 mm	AAA.15000200.00		
	3000 mm	3000 mm	AAA.15000300.00		
	6000 mm	6000 mm	AAA.15000600.00		

* cannot be combined with ESSI*

Fittings selection

	Compact suspension	Min. door width	Min. door width ESSI	Reference
	With 2 stoppers	357 mm	443 mm	AAA.20100000.00
	Double-action softclose	590 mm	664 mm	AAA.20120000.00
	With 2 stoppers	357 mm	443 mm	AAA.20200000.00
	Double-action softclose	590 mm	664 mm	AAA.20220000.00

Every fitting set comes with all the rollers or softclose mechanisms, suspension, guiding systems and stoppers you need.

Complete sets

	Max. door width	Length			
With 2 stoppers	1000 mm	2000 mm	AAA.33100200.02	AAA.33100200.07	AAA.33100200.05
Double-action softclose	1000 mm	2000 mm	AAA.33102200.02	AAA.33102200.07	AAA.33102200.05



argenta **XPERTA AUTOCLOSE**

What are the benefits ?

- Closes softly through self-braking weights and softclose mechanism
- The system is always concealed behind the door

Features

- Suitable for ceiling or wall mounting
- The minimum required space between the door and wall is 13 mm
- Maximum door width = door height - 850 mm

Info

The **AK0.192** Autoclose set can be combined with the following fitting set:

Fittings	Reference
Standard fix with 2 softcloses	AAA.20020000.00



Xperta 100 kg **FLUSH INTO CEILING**

The Xperta invisible is the ultimate solution for ceiling high applications where the profile is seamlessly integrated into a suspended ceiling. The profile can be finished with standard plasterboard, or whatever skirting that might be chosen. The compact suspension ensures the clearance between door and ceiling is limited to minimum 4 mm for an extremely sleek finish.

PROFILE LENGTH

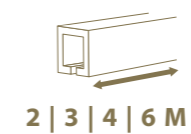

2 | 3 | 4 | 6 M

INSTALLATION



DOOR WEIGHT



grey anodised
aluminium

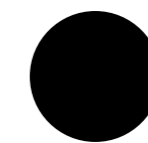

black anodised
aluminium



white matte coating
RAL 9016



Technical drawings

For suspended ceiling (1+2)

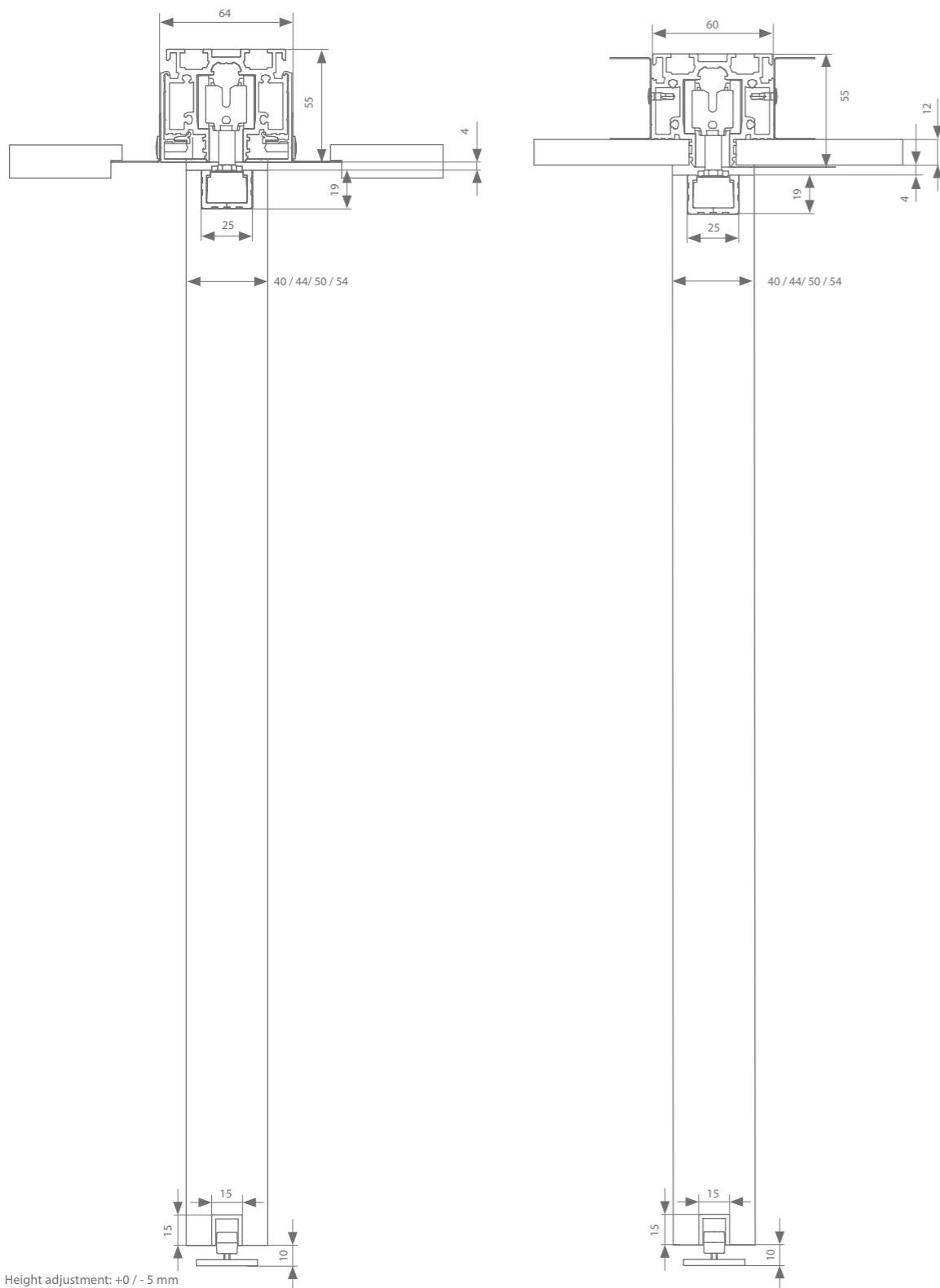
For plasterboard (1)



Profiles

	Max. door width	Length			
Running track (1)	1000 mm	2000 mm	AAA.11100200.02	AAA.11100200.07	AAA.11100200.05
	1500 mm	3000 mm	AAA.11100300.02	AAA.11100300.07	AAA.11100300.05
	2000 mm	4000 mm	AAA.11100400.02	AAA.11100400.07	AAA.11100400.05
	3000 mm	6000 mm	AAA.11100600.02	AAA.11100600.07	AAA.11100600.05
ESSI®-module (optional)		100 mm	AAA.11110010.02	AAA.11110010.07	AAA.11110010.05
2 x extra cover profile for suspended ceilings (2)	1000 mm	2000 mm			AAA.11120200.05
	1500 mm	3000 mm			AAA.11120300.05
	2000 mm	4000 mm			AAA.11120400.05
	3000 mm	6000 mm			AAA.11120600.05
+ 2 x for ESSI					AAA.11113010.05
Suspension profile (optional)	1000 mm	1000 mm	AAA.14000100.00		
	1250 mm	1250 mm	AAA.14000125.00		
	1500 mm	1500 mm	AAA.14000150.00		
	2000 mm	2000 mm	AAA.14000200.00		
	3000 mm	3000 mm	AAA.14000300.00		
	6000 mm	6000 mm	AAA.14000600.00		
End cap suspension profile (optional)			AAA.94000000.02	AAA.94000000.07	AAA.94000000.05
Bottom guiding track	1000 mm	1000 mm	AAA.15000100.00		
	1250 mm	1250 mm	AAA.15000125.00		
	1500 mm	1500 mm	AAA.15000150.00		
	2000 mm	2000 mm	AAA.15000200.00		
	3000 mm	3000 mm	AAA.15000300.00		
	6000 mm	6000 mm	AAA.15000600.00		

Fittings selection

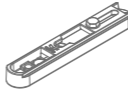
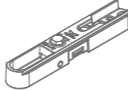
Compact suspension		Min. door width	Min. door width ESSI	Reference
	With 2 stoppers	357 mm	443 mm	AAA.20100000.00
	Double-action softclose	590 mm	664 mm	AAA.20120000.00
	With 2 stoppers	357 mm	443 mm	AAA.20200000.00
	Double-action softclose	590 mm	664 mm	AAA.20220000.00

Every fitting set comes with all the rollers or softclose mechanisms, suspension, guiding systems and stoppers you need.



Xperta 100 kg **SYMMETRIC**

In a symmetric configuration, both doors are connected by a reinforced dented belt that coordinates simultaneous movement. User comfort is guaranteed: you can open and close both door panels with just one finger! Ceiling and wall mounting are both possible within this setup.

PROFILE LENGTH

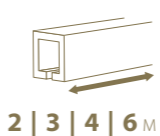

2 | 3 | 4 | 6 M

INSTALLATION



DOOR THICKNESS

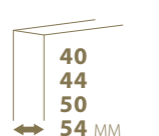

40
44
50
54 MM

DOOR WEIGHT



MAX.
100
KG



anodised aluminium



black textured coating
RAL 9005



white textured coating
RAL 9016

Technical drawings

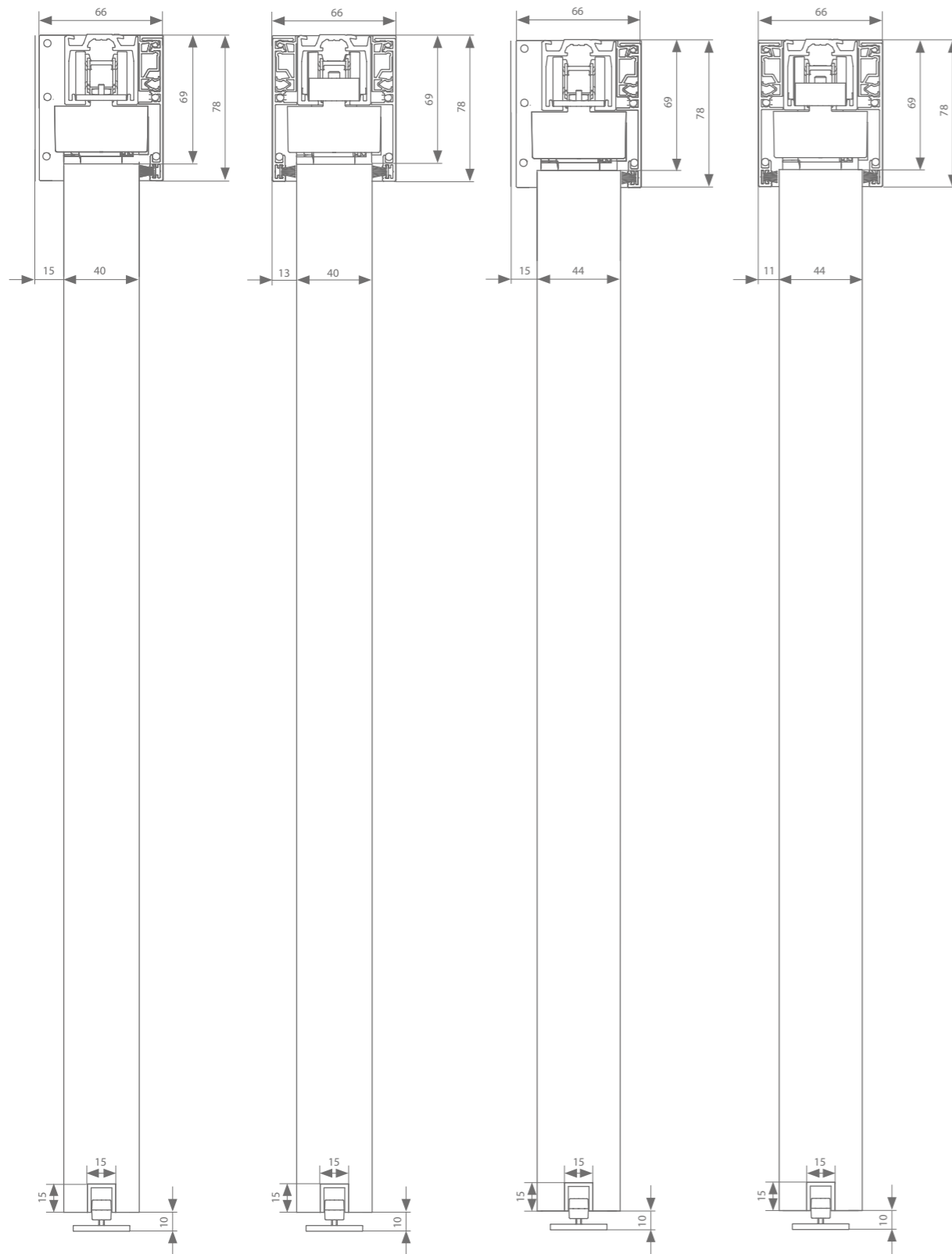

Ceiling mount 40 mm

Ceiling mount 44 mm



Height adjustment: + - 4 mm

Profiles

	Max. door width	Length			
Running track	500 mm	2000 mm	AAA.11000200.02	AAA.11000200.07	AAA.11000200.05
	750 mm	3000 mm	AAA.11000300.02	AAA.11000300.07	AAA.11000300.05
	1000 mm	4000 mm	AAA.11000400.02	AAA.11000400.07	AAA.11000400.05
	1500 mm	6000 mm	AAA.11000600.02	AAA.11000600.07	AAA.11000600.05
ESSI®-module (optional)		100 mm	AAA.11010010.02	AAA.11010010.07	AAA.11010010.05
Cover profile	500 mm	2000 mm	AAA.12000200.02	AAA.12000200.07	AAA.12000200.05
	750 mm	3000 mm	AAA.12000300.02	AAA.12000300.07	AAA.12000300.05
	1000 mm	4000 mm	AAA.12000400.02	AAA.12000400.07	AAA.12000400.05
	1500 mm	6000 mm	AAA.12000600.02	AAA.12000600.07	AAA.12000600.05
+ narrow clips 1 per metre of cover profile		100 mm		AAA.12010010.07	
Set of end caps			AAA.92020000.02	AAA.92020000.07	AAA.92020000.05
Seal	500 mm	2000 mm	AAA.12010200.02	AAA.12010200.07	
	750 mm	3000 mm	AAA.12010300.02	AAA.12010300.07	
	1000 mm	4000 mm	AAA.12010400.02	AAA.12010400.07	
	1500 mm	6000 mm	AAA.12010600.02	AAA.12010600.07	
Bottom guiding track	1000 mm	1000 mm	AAA.15000100.00		
	1250 mm	1250 mm	AAA.15000125.00		
	1500 mm	1500 mm	AAA.15000150.00		
	2000 mm	2000 mm	AAA.15000200.00		
	3000 mm	3000 mm	AAA.15000300.00		
	6000 mm	6000 mm	AAA.15000600.00		

Fittings selection

Transverse suspension	Min. door width	Min. door width ESSI	Length	Reference
Symmetric	427 mm	518 mm		AAA.20001000.00
Belt	Min. belt length = (8 x door width) + 200 mm		50 m	AK9.709.050
			20 m	AK9.709.020
			10 m	AK9.709.010

Motorised set*

Transverse suspension with motor	Min. door width	Min. door width ESSI	Length	Reference
Fittings	A-slide** (max. 60 kg/door)	542 mm		AAA.20031000.00
Belt	Min. belt length = (8 x door width) + 200 mm		50 m	AK9.709.050
			20 m	AK9.709.020
			10 m	AK9.709.010
Remote control	for 1 channel			AM3.100.104.61
	for 4 channels			AM3.100.104.64

* see p.68 for more information

** For matching end caps and clips, see p.41.

Every fitting set comes with all the rollers or softclose mechanisms, suspension, guiding systems and stoppers you need.

Technical drawings

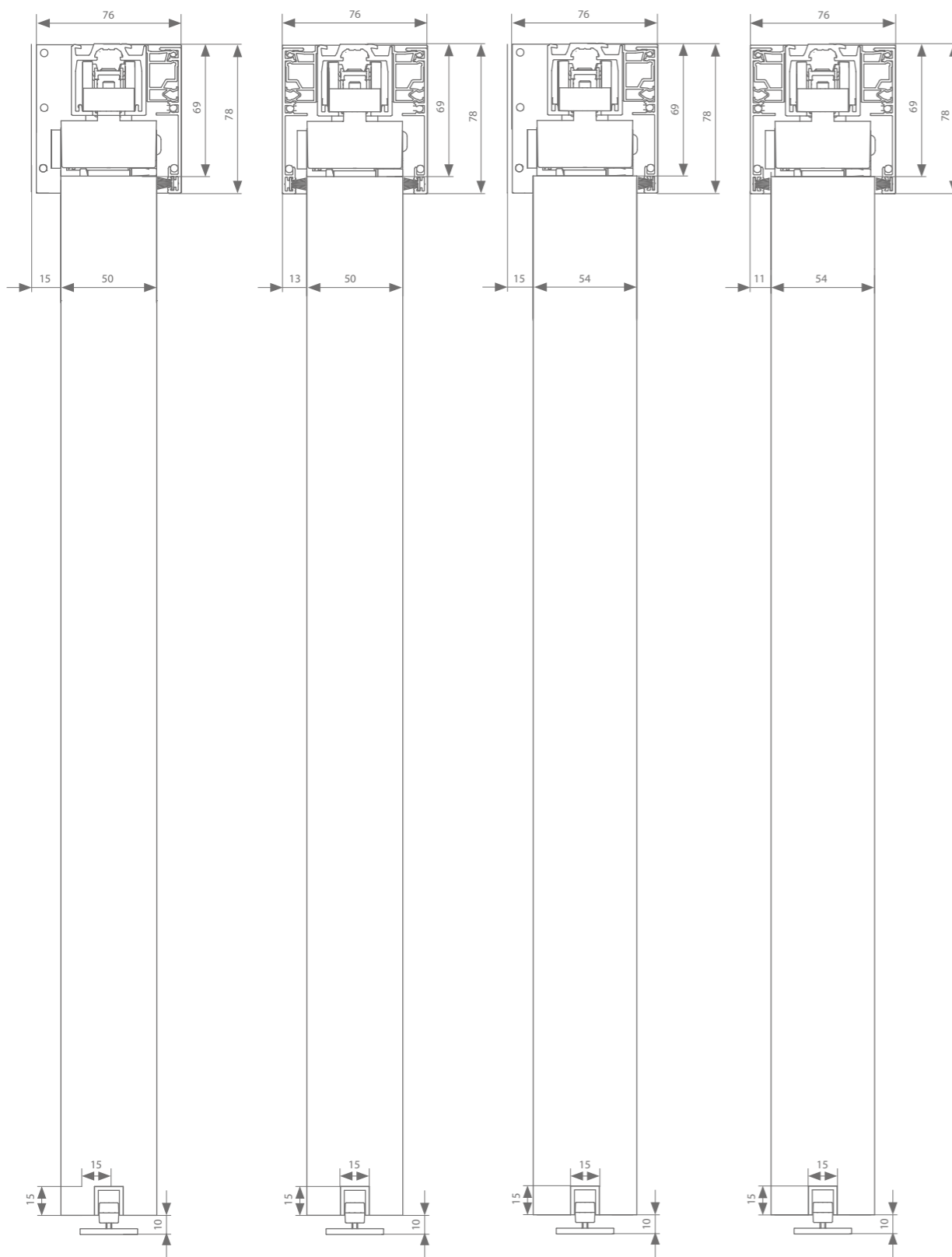

Ceiling mount 50 mm

Ceiling mount 54 mm



Height adjustment: + - 4 mm

Profiles

	Max. door width	Length			
Running track	500 mm	2000 mm	AAA.11000200.02	AAA.11000200.07	AAA.11000200.05
	750 mm	3000 mm	AAA.11000300.02	AAA.11000300.07	AAA.11000300.05
	1000 mm	4000 mm	AAA.11000400.02	AAA.11000400.07	AAA.11000400.05
	1500 mm	6000 mm	AAA.11000600.02	AAA.11000600.07	AAA.11000600.05
ESSI®-module (optional)		100 mm	AAA.11010010.02	AAA.11010010.07	AAA.11010010.05
Cover profile	500 mm	2000 mm	AAA.12000200.02	AAA.12000200.07	AAA.12000200.05
	750 mm	3000 mm	AAA.12000300.02	AAA.12000300.07	AAA.12000300.05
	1000 mm	4000 mm	AAA.12000400.02	AAA.12000400.07	AAA.12000400.05
	1500 mm	6000 mm	AAA.12000600.02	AAA.12000600.07	AAA.12000600.05
+ wide clips 1 per metre of cover profile		100 mm 1000 mm		AAA.12020010.07 AAA.12020100.07	
Set of end caps			AAA.92040000.02	AAA.92040000.07	AAA.92040000.05
Seal	500 mm	2000 mm	AAA.12010200.02	AAA.12010200.07	
	750 mm	3000 mm	AAA.12010300.02	AAA.12010300.07	
	1000 mm	4000 mm	AAA.12010400.02	AAA.12010400.07	
	1500 mm	6000 mm	AAA.12010600.02	AAA.12010600.07	
Bottom guiding track	1000 mm	1000 mm	AAA.15000100.00		
	1250 mm	1250 mm	AAA.15000125.00		
	1500 mm	1500 mm	AAA.15000150.00		
	2000 mm	2000 mm	AAA.15000200.00		
	3000 mm 6000 mm	3000 mm 6000 mm	AAA.15000300.00 AAA.15000600.00		

Fittings selection

Transverse suspension	Min. door width	Min. door width ESSI	Length	Reference
Symmetric	427 mm	518 mm		AAA.20001000.00
Belt	Min. belt length = (8 x door width) + 200 mm		50 m	AK9.709.050
			20 m	AK9.709.020
			10 m	AK9.709.010

Motorised set*

Transverse suspension with motor	Min. door width	Min. door width ESSI	Length	Reference
Fittings	A-slide (max. 60 kg/door)	542 mm		AAA.20031000.00
Belt	Min. belt length = (8 x door width) + 200 mm		50 m	AK9.709.050
			20 m	AK9.709.020
			10 m	AK9.709.010
Remote control	for 1 channel			AM3.100.104.61
	for 4 channels			AM3.100.104.64

* see p.68 for more information

Every fitting set comes with all the rollers or softclose mechanisms, suspension, guiding systems and stoppers you need.

Technical drawings

Wall mount 40 mm

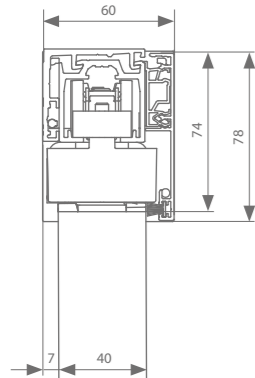

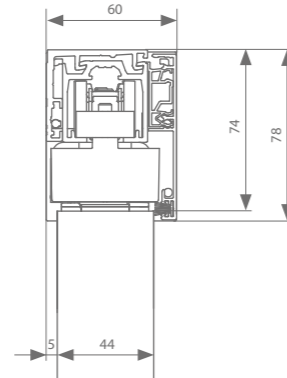

Wall mount 44 mm



Height adjustment: + - 4 mm

Profiles

	Max. door width	Length			
Running track	500 mm	2000 mm	AAA.11000200.02	AAA.11000200.07	AAA.11000200.05
	750 mm	3000 mm	AAA.11000300.02	AAA.11000300.07	AAA.11000300.05
	1000 mm	4000 mm	AAA.11000400.02	AAA.11000400.07	AAA.11000400.05
	1500 mm	6000 mm	AAA.11000600.02	AAA.11000600.07	AAA.11000600.05
ESSI®-module (optional)		100 mm	AAA.11010010.02	AAA.11010010.07	AAA.11010010.05
Wall profile	500 mm	2000 mm	AAA.13000200.02	AAA.13000200.07	AAA.13000200.05
	750 mm	3000 mm	AAA.13000300.02	AAA.13000300.07	AAA.13000300.05
	1000 mm	4000 mm	AAA.13000400.02	AAA.13000400.07	AAA.13000400.05
	1500 mm	6000 mm	AAA.13000600.02	AAA.13000600.07	AAA.13000600.05
+ mounting set	1 per 3 meter	100 mm		AAA.13010000.07	
Cover profile	500 mm	2000 mm	AAA.12000200.02	AAA.12000200.07	AAA.12000200.05
	750 mm	3000 mm	AAA.12000300.02	AAA.12000300.07	AAA.12000300.05
	1000 mm	4000 mm	AAA.12000400.02	AAA.12000400.07	AAA.12000400.05
	1500 mm	6000 mm	AAA.12000600.02	AAA.12000600.07	AAA.12000600.05
+ narrow clips 1 per metre of cover profile		100 mm		AAA.12010010.07	
Set of end caps			AAA.92000000.02	AAA.92000000.07	AAA.92000000.05
Seal	500 mm	2000 mm	AAA.12010200.02	AAA.12010200.07	
	750 mm	3000 mm	AAA.12010300.02	AAA.12010300.07	
	1000 mm	4000 mm	AAA.12010400.02	AAA.12010400.07	
	1500 mm	6000 mm	AAA.12010600.02	AAA.12010600.07	
Bottom guiding track	1000 mm	1000 mm	AAA.15000100.00		
	1250 mm	1250 mm	AAA.15000125.00		
	1500 mm	1500 mm	AAA.15000150.00		
	2000 mm	2000 mm	AAA.15000200.00		
	3000 mm	3000 mm	AAA.15000300.00		
	6000 mm	6000 mm	AAA.15000600.00		

Fittings selection

Transverse suspension	Min. door width	Min. door width ESSI	Length	Reference
Symmetric	427 mm	518 mm		AAA.20001000.00
Belt	Min. belt length = (8 x door width) + 200 mm		50 m	AK9.709.050
			20 m	AK9.709.020
			10 m	AK9.709.010

Motorised set*

Transverse suspension with motor	Min. door width	Min. door width ESSI	Length	Reference
Fittings	A-slide** (max. 60 kg/door)	542 mm	592 mm	AAA.20031000.00
Belt	Min. belt length = (8 x door width) + 200 mm		50 m	AK9.709.050
			20 m	AK9.709.020
			10 m	AK9.709.010
Remote control	for 1 channel			AM3.100.104.61
	for 4 channels			AM3.100.104.64

* see p.68 for more information

Every fitting set comes with all the rollers or softclose mechanisms, suspension, guiding systems and stoppers you need.

** Cannot be combined with cover profiles and end caps

argenta Xperta wood
wall mount symmetric 50/54 mm without skirting

Technical drawings

Wall mount 50 mm

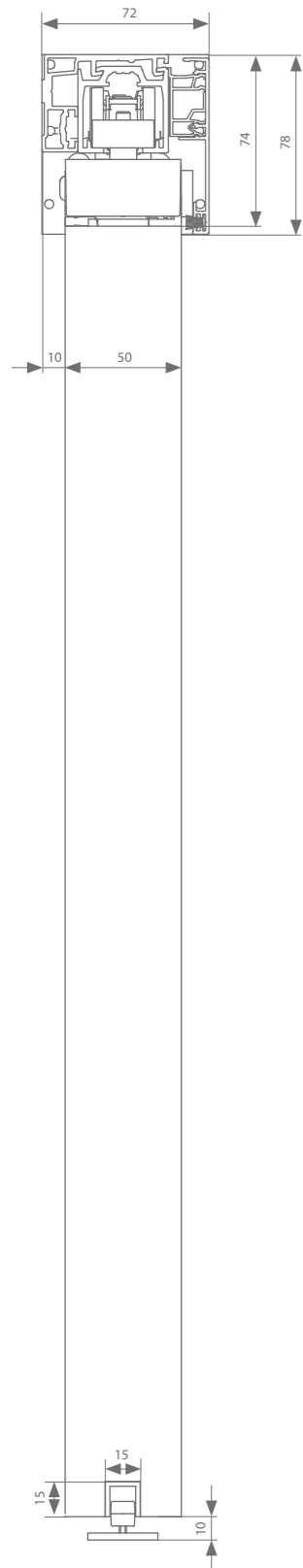

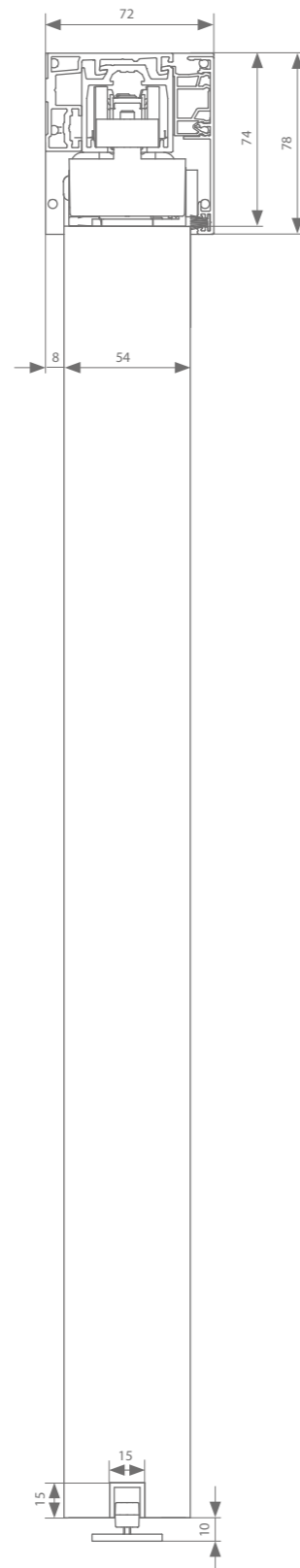

Height adjustment: + - 4 mm

Wall mount 54 mm



assemble your set 

Profiles

	Max. door width	Length			
Running track	500 mm	2000 mm	AAA.11000200.02	AAA.11000200.07	AAA.11000200.05
	750 mm	3000 mm	AAA.11000300.02	AAA.11000300.07	AAA.11000300.05
	1000 mm	4000 mm	AAA.11000400.02	AAA.11000400.07	AAA.11000400.05
	1500 mm	6000 mm	AAA.11000600.02	AAA.11000600.07	AAA.11000600.05
ESSI®-module (optional)		100 mm	AAA.11010010.02	AAA.11010010.07	AAA.11010010.05
Wall profile	500 mm	2000 mm	AAA.13100200.02	AAA.13100200.07	AAA.13100200.05
	750 mm	3000 mm	AAA.13100300.02	AAA.13100300.07	AAA.13100300.05
	1000 mm	4000 mm	AAA.13100400.02	AAA.13100400.07	AAA.13100400.05
	1500 mm	6000 mm	AAA.13100600.02	AAA.13100600.07	AAA.13100600.05
+ mounting set			AAA.13010000.07		
Cover profile	500 mm	2000 mm	AAA.12000200.02	AAA.12000200.07	AAA.12000200.05
	750 mm	3000 mm	AAA.12000300.02	AAA.12000300.07	AAA.12000300.05
	1000 mm	4000 mm	AAA.12000400.02	AAA.12000400.07	AAA.12000400.05
	1500 mm	6000 mm	AAA.12000600.02	AAA.12000600.07	AAA.12000600.05
+ wide clips 1 per metre of cover profile		100 mm 1000 mm		AAA.12020010.07 AAA.12020100.07	
Set of end caps			AAA.92030000.02	AAA.92030000.07	AAA.92030000.05
Seal	500 mm	2000 mm	AAA.12010200.02	AAA.12010200.07	
	750 mm	3000 mm	AAA.12010300.02	AAA.12010300.07	
	1000 mm	4000 mm	AAA.12010400.02	AAA.12010400.07	
	1500 mm	6000 mm	AAA.12010600.02	AAA.12010600.07	
Bottom guiding track	1000 mm	1000 mm	AAA.15000100.00		
	1250 mm	1250 mm	AAA.15000125.00		
	1500 mm	1500 mm	AAA.15000150.00		
	2000 mm	2000 mm	AAA.15000200.00		
	3000 mm	3000 mm	AAA.15000300.00		
	6000 mm	6000 mm	AAA.15000600.00		

Fittings selection

Transverse suspension	Min. door width	Min. door width ESSI	Length	Reference
Symmetric	427 mm	518 mm		AAA.20001000.00
Belt	Min. belt length = (8 x door width) + 200 mm		50 m	AK9.709.050
			20 m	AK9.709.020
			10 m	AK9.709.010

Motorised set*

Transverse suspension with motor	Min. door width	Min. door width ESSI	Length	Reference
Fittings	A-slide (max. 60 kg/door)	542 mm		AAA.20031000.00
Belt	Min. belt length = (8 x door width) + 200 mm		50 m	AK9.709.050
			20 m	AK9.709.020
			10 m	AK9.709.010
Remote control	for 1 channel			AM3.100.104.61
			for 4 channels	AM3.100.104.64

* see p.68 for more information

Every fitting set comes with all the rollers or softclose mechanisms, suspension, guiding systems and stoppers you need.

Technical drawings

Wall mount 40 mm

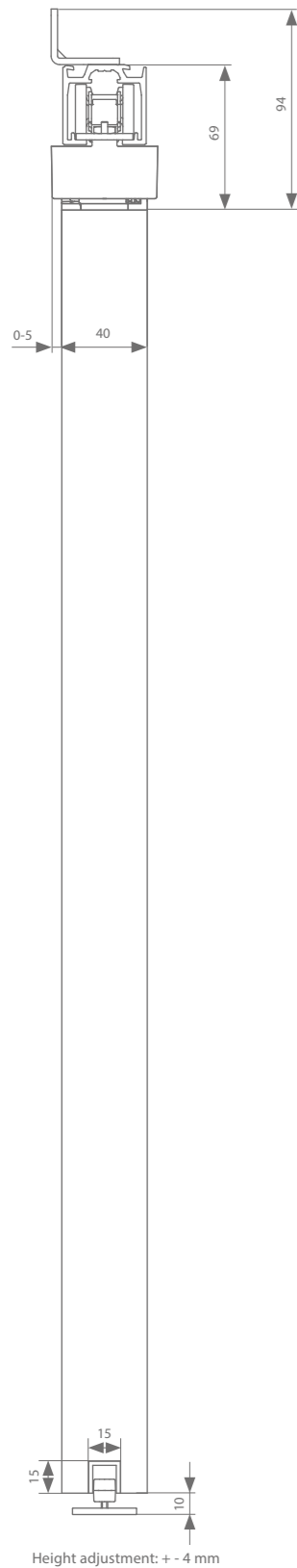

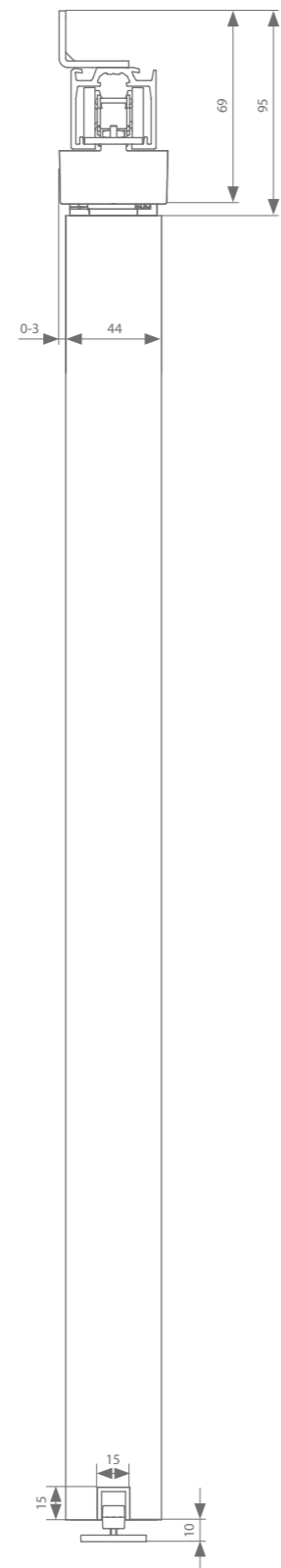

Wall mount 44 mm



Height adjustment: + - 4 mm

Profiles

	Max. door width	Length			
Running track	500 mm	2000 mm	AAA.11000200.02	AAA.11000200.07	AAA.11000200.05
	750 mm	3000 mm	AAA.11000300.02	AAA.11000300.07	AAA.11000300.05
	1000 mm	4000 mm	AAA.11000400.02	AAA.11000400.07	AAA.11000400.05
	1500 mm	6000 mm	AAA.11000600.02	AAA.11000600.07	AAA.11000600.05
ESSI®-module (optional)		100 mm	AAA.11010010.02	AAA.11010010.07	AAA.11010010.05
Wall bracket		every 500 mm needed	AAA.01000000.01		
Bottom guiding track	1000 mm	1000 mm	AAA.15000100.00		
	1250 mm	1250 mm	AAA.15000125.00		
	1500 mm	1500 mm	AAA.15000150.00		
	2000 mm	2000 mm	AAA.15000200.00		
	3000 mm	3000 mm	AAA.15000300.00		
	6000 mm	6000 mm	AAA.15000600.00		

Fittings selection

Transverse suspension	Min. door width	Min. door width ESSI	Length	Reference
Symmetric	427 mm	518 mm		AAA.20001000.00
Belt	Min. belt length = (8 x door width) + 200 mm		50 m	AK9.709.050
			20 m	AK9.709.020
			10 m	AK9.709.010

Motorised set*

Transverse suspension with motor	Min. door width	Min. door width ESSI	Length	Reference
Fittings	A-slide (max. 60 kg/door)	542 mm		AAA.20031000.00
Belt	Min. belt length = (8 x door width) + 200 mm		50 m	AK9.709.050
			20 m	AK9.709.020
			10 m	AK9.709.010
Remote control	for 1 channel			AM3.100.104.61
	for 4 channels			AM3.100.104.64

* see p.68 for more information

Every fitting set comes with all the rollers or softclose mechanisms, suspension, guiding systems and stoppers you need.

Technical drawings

Wall mount 50 mm

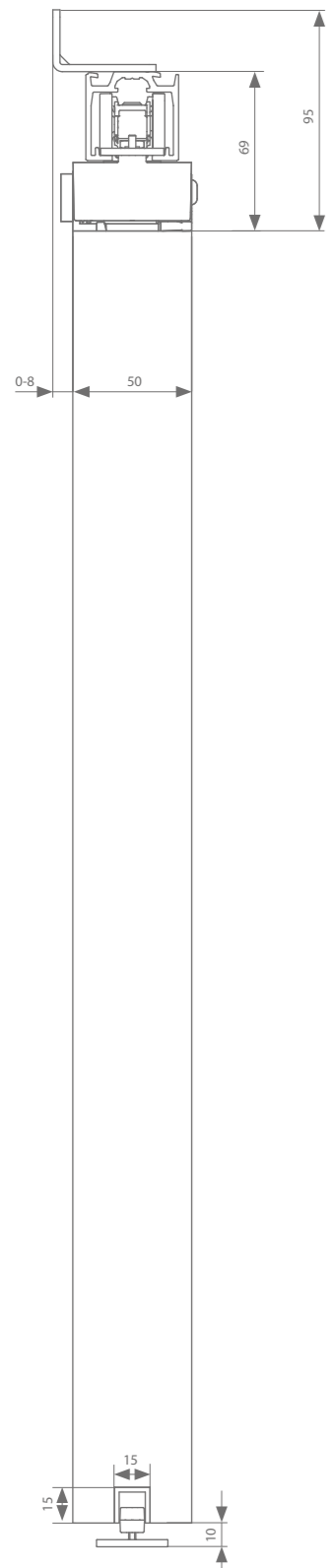

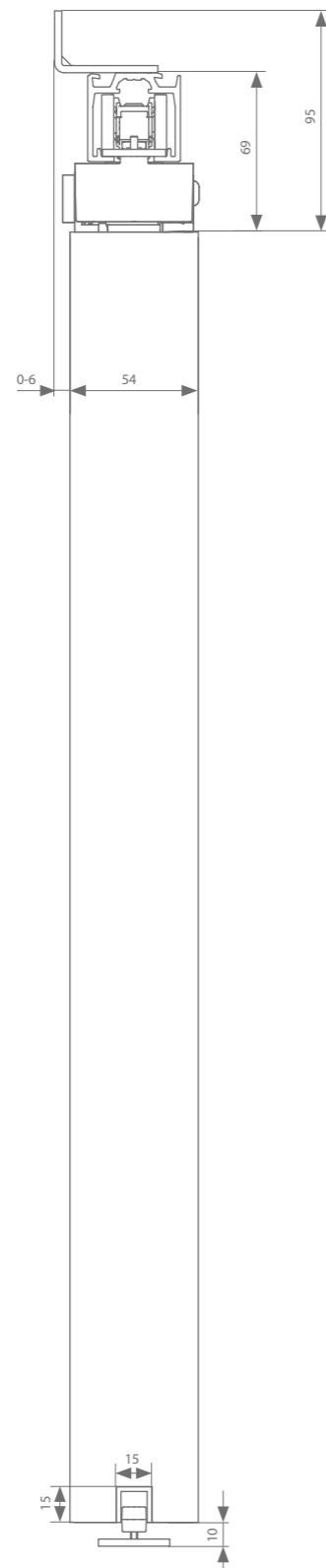

Wall mount 54 mm



Height adjustment: + - 4 mm

Profiles

	Max. door width	Length			
Running track	500 mm	2000 mm	AAA.11000200.02	AAA.11000200.07	AAA.11000200.05
	750 mm	3000 mm	AAA.11000300.02	AAA.11000300.07	AAA.11000300.05
	1000 mm	4000 mm	AAA.11000400.02	AAA.11000400.07	AAA.11000400.05
	1500 mm	6000 mm	AAA.11000600.02	AAA.11000600.07	AAA.11000600.05
ESSI®-module (optional)		100 mm	AAA.11010010.02	AAA.11010010.07	AAA.11010010.05
Wall bracket		every 500 mm needed	AAA.01100000.01		
Bottom guiding track	1000 mm	1000 mm	AAA.15000100.00		
	1250 mm	1250 mm	AAA.15000125.00		
	1500 mm	1500 mm	AAA.15000150.00		
	2000 mm	2000 mm	AAA.15000200.00		
	3000 mm	3000 mm	AAA.15000300.00		
	6000 mm	6000 mm	AAA.15000600.00		

Fittings selection

Transverse suspension	Min. door width	Min. door width ESSI	Length	Reference
Symmetric	427 mm	518 mm		AAA.20001000.00
Belt	Min. belt length = (8 x door width) + 200 mm		50 m	AK9.709.050
			20 m	AK9.709.020
			10 m	AK9.709.010

Motorised set*

Transverse suspension with motor	Min. door width	Min. door width ESSI	Length	Reference
Fittings	A-slide (max. 60 kg/door)	542 mm		AAA.20031000.00
Belt	Min. belt length = (8 x door width) + 200 mm		50 m	AK9.709.050
			20 m	AK9.709.020
			10 m	AK9.709.010
Remote control	for 1 channel			AM3.100.104.61
	for 4 channels			AM3.100.104.64

* see p.68 for more information

Every fitting set comes with all the rollers or softclose mechanisms, suspension, guiding systems and stoppers you need.

Technical drawings

Wall mount 40 mm

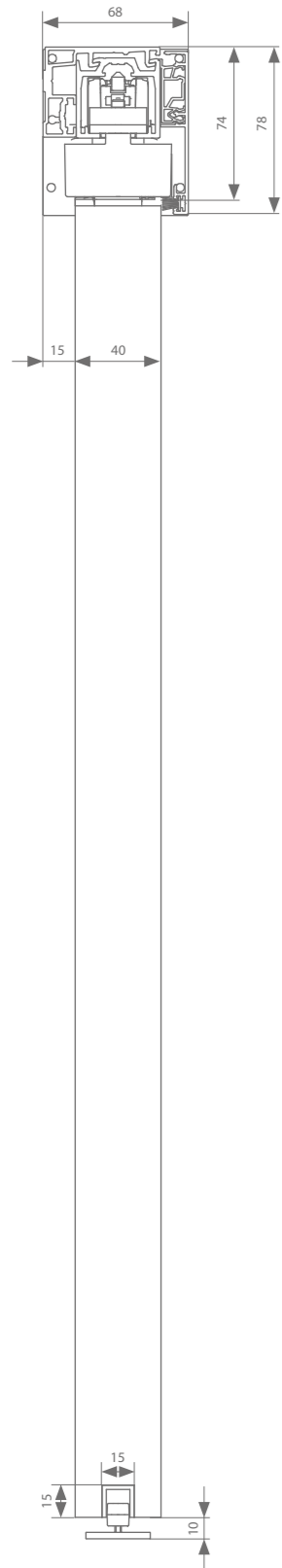

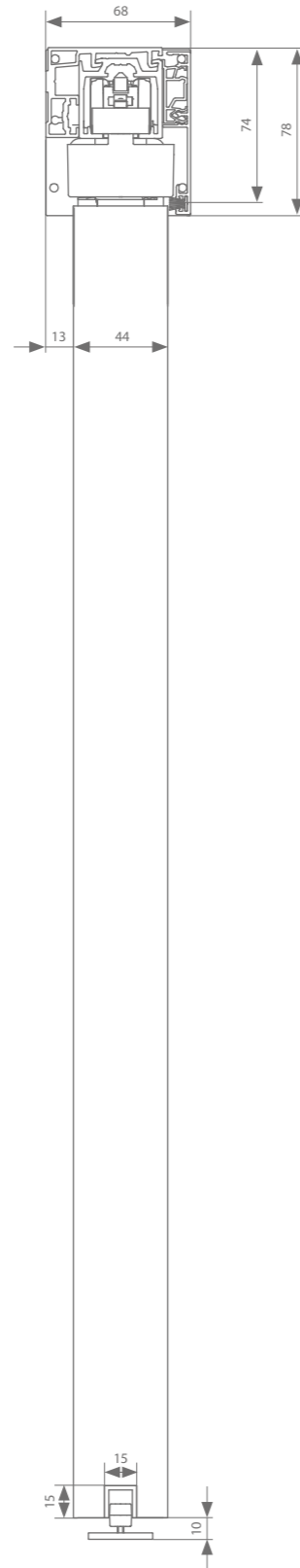

Height adjustment: + - 4 mm

Wall mount 44 mm



Profiles

	Max. door width	Length			
Running track	500 mm	2000 mm	AAA.11000200.02	AAA.11000200.07	AAA.11000200.05
	750 mm	3000 mm	AAA.11000300.02	AAA.11000300.07	AAA.11000300.05
	1000 mm	4000 mm	AAA.11000400.02	AAA.11000400.07	AAA.11000400.05
	1500 mm	6000 mm	AAA.11000600.02	AAA.11000600.07	AAA.11000600.05
ESSI®-module (optional)		100 mm	AAA.11010010.02	AAA.11010010.07	AAA.11010010.05
Wall profile	500 mm	2000 mm	AAA.13100200.02	AAA.13100200.07	AAA.13100200.05
	750 mm	3000 mm	AAA.13100300.02	AAA.13100300.07	AAA.13100300.05
	1000 mm	4000 mm	AAA.13100400.02	AAA.13100400.07	AAA.13100400.05
	1500 mm	6000 mm	AAA.13100600.02	AAA.13100600.07	AAA.13100600.05
+ mounting set	1 per 3 meter	100 mm		AAA.13010000.07	
Cover profile	500 mm	2000 mm	AAA.12000200.02	AAA.12000200.07	AAA.12000200.05
	750 mm	3000 mm	AAA.12000300.02	AAA.12000300.07	AAA.12000300.05
	1000 mm	4000 mm	AAA.12000400.02	AAA.12000400.07	AAA.12000400.05
	1500 mm	6000 mm	AAA.12000600.02	AAA.12000600.07	AAA.12000600.05
+ narrow clips 1 per metre of cover profile		100 mm		AAA.12010010.07	
Set of end caps			AAA.92010000.02	AAA.92010000.07	AAA.92010000.05
Seal	500 mm	2000 mm	AAA.12010200.02	AAA.12010200.07	
	750 mm	3000 mm	AAA.12010300.02	AAA.12010300.07	
	1000 mm	4000 mm	AAA.12010400.02	AAA.12010400.07	
	1500 mm	6000 mm	AAA.12010600.02	AAA.12010600.07	
Bottom guiding track	1000 mm	1000 mm	AAA.15000100.00		
	1250 mm	1250 mm	AAA.15000125.00		
	1500 mm	1500 mm	AAA.15000150.00		
	2000 mm	2000 mm	AAA.15000200.00		
	3000 mm	3000 mm	AAA.15000300.00		
	6000 mm	6000 mm	AAA.15000600.00		

Fittings selection

Transverse suspension	Min. door width	Min. door width ESSI	Length	Reference
Symmetric	427 mm	518 mm		AAA.20001000.00
Belt			50 m	AK9.709.050
			20 m	AK9.709.020
			10 m	AK9.709.010

Motorised set*

Transverse suspension with motor	Min. door width	Min. door width ESSI	Length	Reference
Fittings	A-slide** (max. 60 kg/door)	542 mm		AAA.20031000.00
Belt			50 m	AK9.709.050
			20 m	AK9.709.020
			10 m	AK9.709.010
Remote control				AM3.100.104.61
				AM3.100.104.64

* see p.68 for more information

** For matching end caps and clips, see p.45.

Every fitting set comes with all the rollers or softclose mechanisms, suspension, guiding systems and stoppers you need.

Technical drawings

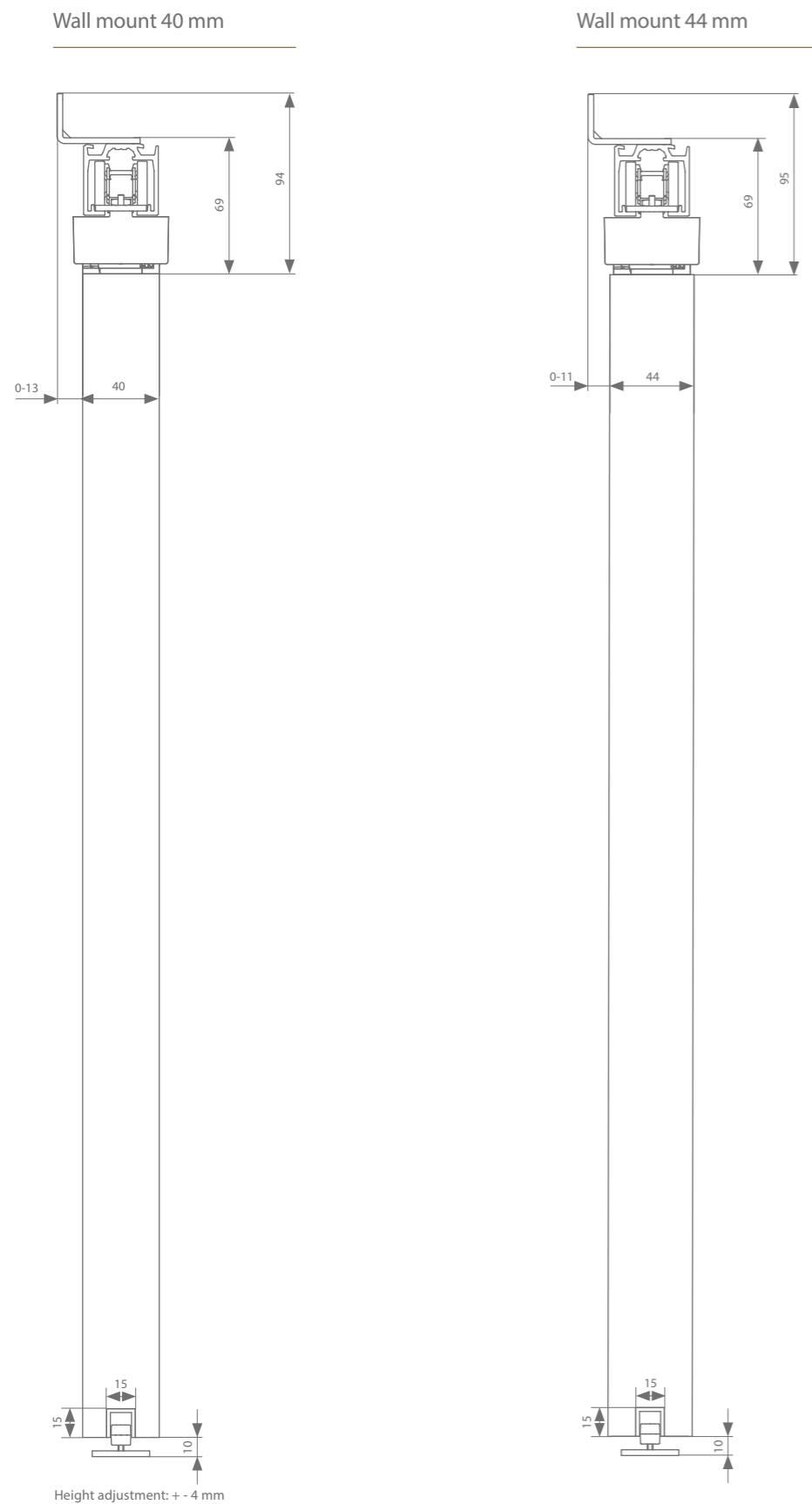

Profiles

	Max. door width	Length			
Running track	500 mm	2000 mm	AAA.11000200.02	AAA.11000200.07	AAA.11000200.05
	750 mm	3000 mm	AAA.11000300.02	AAA.11000300.07	AAA.11000300.05
	1000 mm	4000 mm	AAA.11000400.02	AAA.11000400.07	AAA.11000400.05
	1500 mm	6000 mm	AAA.11000600.02	AAA.11000600.07	AAA.11000600.05
ESSI®-module (optional)		100 mm	AAA.11010010.02	AAA.11010010.07	AAA.11010010.05
Wall bracket		every 500 mm needed	AAA.01100000.01		
Bottom guiding track	1000 mm	1000 mm	AAA.15000100.00		
	1250 mm	1250 mm	AAA.15000125.00		
	1500 mm	1500 mm	AAA.15000150.00		
	2000 mm	2000 mm	AAA.15000200.00		
	3000 mm	3000 mm	AAA.15000300.00		
	6000 mm	6000 mm	AAA.15000600.00		

Fittings selection

Transverse suspension	Min. door width	Min. door width ESSI	Length	Reference
Symmetric	427 mm	518 mm		AAA.20001000.00
Belt	Min. belt length = (8 x door width) + 200 mm		50 m	AK9.709.050
			20 m	AK9.709.020
			10 m	AK9.709.010

Motorised set*

Transverse suspension with motor	Min. door width	Min. door width ESSI	Length	Reference
Fittings	A-slide (max. 60 kg/door)	542 mm		AAA.20031000.00
Belt	Min. belt length = (8 x door width) + 200 mm		50 m	AK9.709.050
			20 m	AK9.709.020
			10 m	AK9.709.010
Remote control	for 1 channel			AM3.100.104.61
	for 4 channels			AM3.100.104.64

* see p.68 for more information

Every fitting set comes with all the rollers or softclose mechanisms, suspension, guiding systems and stoppers you need.



Xperta 100 kg **TELESCOPIC**

This silent system is available in two versions, one with a belt and one with noggles. In the belt version, all doors move simultaneously so they reach their end point at the same time. In the second version, the noggles move one panel after another.

PROFILE LENGTH

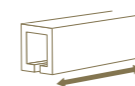

2 | 3 | 4 | 6 M

INSTALLATION



DOOR THICKNESS

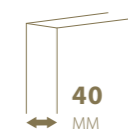

DOOR WEIGHT



anodised aluminium

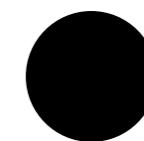

black textured coating
RAL 9005



white textured coating
RAL 9016

argenta Xperta wood
dual telescopic ceiling mount 40 mm

Technical drawings

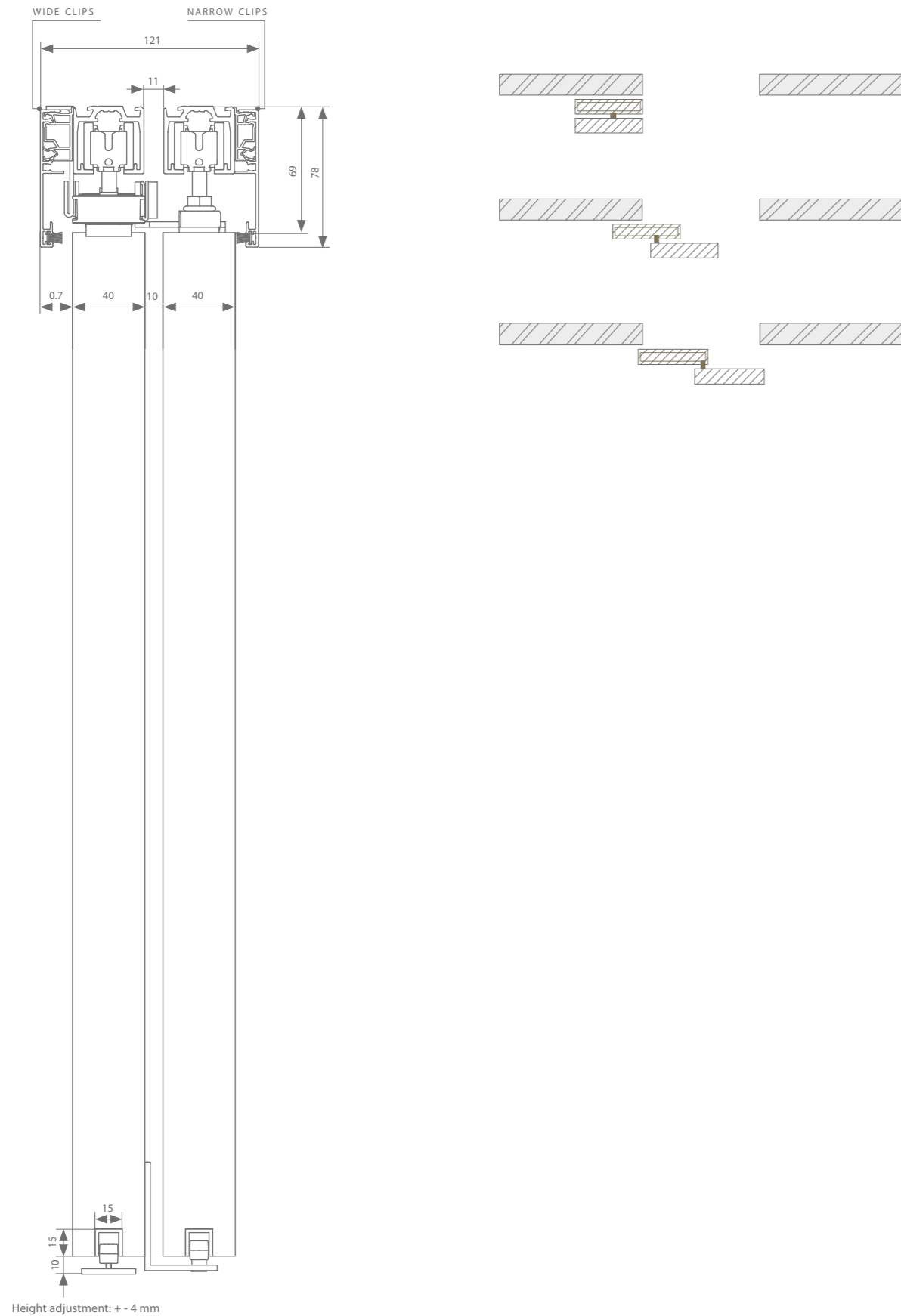

Height adjustment: + - 4 mm

assemble your set

Profiles

	Max. door width	Length			
2 x running track	667 mm	2000 mm	AAA.11000200.02	AAA.11000200.07	AAA.11000200.05
	1000 mm	3000 mm	AAA.11000300.02	AAA.11000300.07	AAA.11000300.05
	1334 mm	4000 mm	AAA.11000400.02	AAA.11000400.07	AAA.11000400.05
	2000 mm	6000 mm	AAA.11000600.02	AAA.11000600.07	AAA.11000600.05
2xESSI®-module (optional)		100 mm	AAA.11010010.02	AAA.11010010.07	AAA.11010010.05
2 x cover profile	667 mm	2000 mm	AAA.12000200.02	AAA.12000200.07	AAA.12000200.05
	1000 mm	3000 mm	AAA.12000300.02	AAA.12000300.07	AAA.12000300.05
	1334 mm	4000 mm	AAA.12000400.02	AAA.12000400.07	AAA.12000400.05
	2000 mm	6000 mm	AAA.12000600.02	AAA.12000600.07	AAA.12000600.05
+ narrow clips 1 per metre of cover profile		100 mm		AAA.12010010.07	
+ wide clips 1 per metre of cover profile		100 mm 1000 mm		AAA.12020010.07 AAA.12020100.07	
2 x seal	667 mm	2000 mm	AAA.12010200.02	AAA.12010200.07	
	1000 mm	3000 mm	AAA.12010300.02	AAA.12010300.07	
	1334 mm	4000 mm	AAA.12010400.02	AAA.12010400.07	
	2000 mm	6000 mm	AAA.12010600.02	AAA.12010600.07	
2 x bottom guiding track	1000 mm	1000 mm	AAA.15000100.00		
	1250 mm	1250 mm	AAA.15000125.00		
	1500 mm	1500 mm	AAA.15000150.00		
	2000 mm	2000 mm	AAA.15000200.00		
	3000 mm	3000 mm	AAA.15000300.00		
	6000 mm	6000 mm	AAA.15000600.00		

Fittings selection

	Transverse suspension		Min. door width	Min. door width ESSI	Length	Reference
	2 x telescopic	1 x necessary	426 mm	472 mm		AAA.20003000.00
	Belt		Min. belt length = (2 x door width) + 400 mm		50 m 20 m 10 m	AK9.709.050 AK9.709.020 AK9.709.010

Motorised set*

	Transverse suspension with motor		Min. door width	Min. door width ESSI	Length	Reference
Fittings	A-slide** (max. 60 kg/door)		742 mm	805 mm		AAA.20033000.00
Belt			Min. belt length = (8 x door width) + 600 mm		50 m 20 m 10 m	AK9.709.050 AK9.709.020 AK9.709.010
Remote control	for 1 channel					AM3.100.104.61
	for 4 channels					AM3.100.104.64

* see p.68 for more information

Every fitting set comes with all the rollers or softclose mechanisms, suspension, guiding systems and stoppers you need.

** Cannot be combined with cover profiles and end caps

Technical drawings

Parallel ceiling mount 1

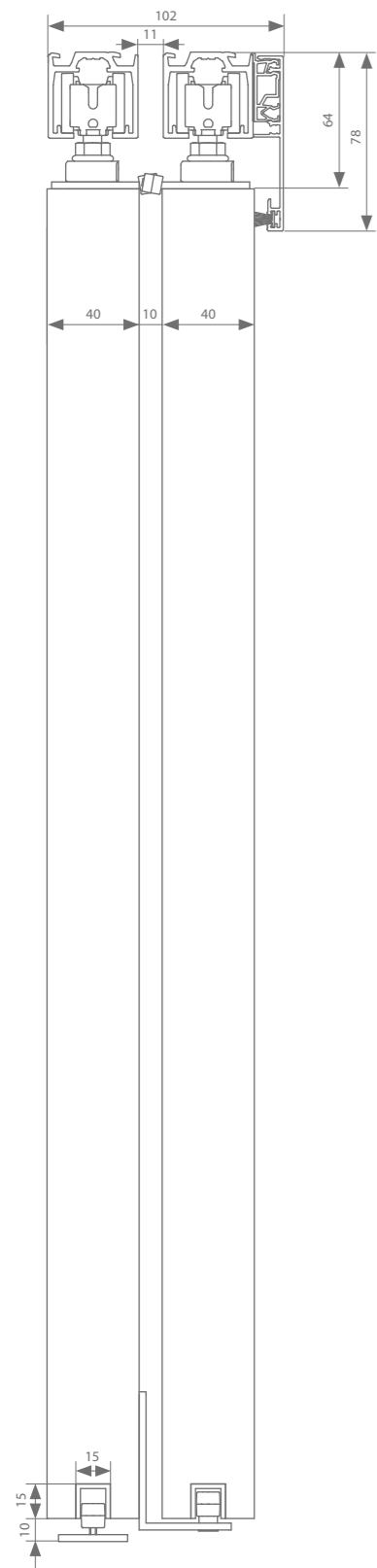

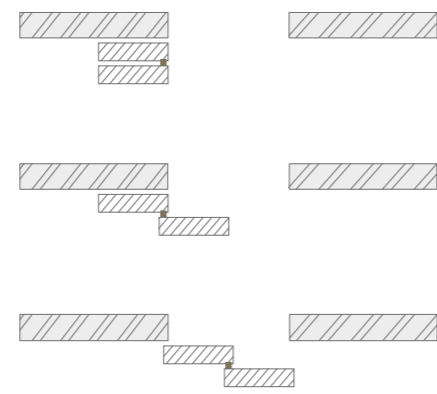
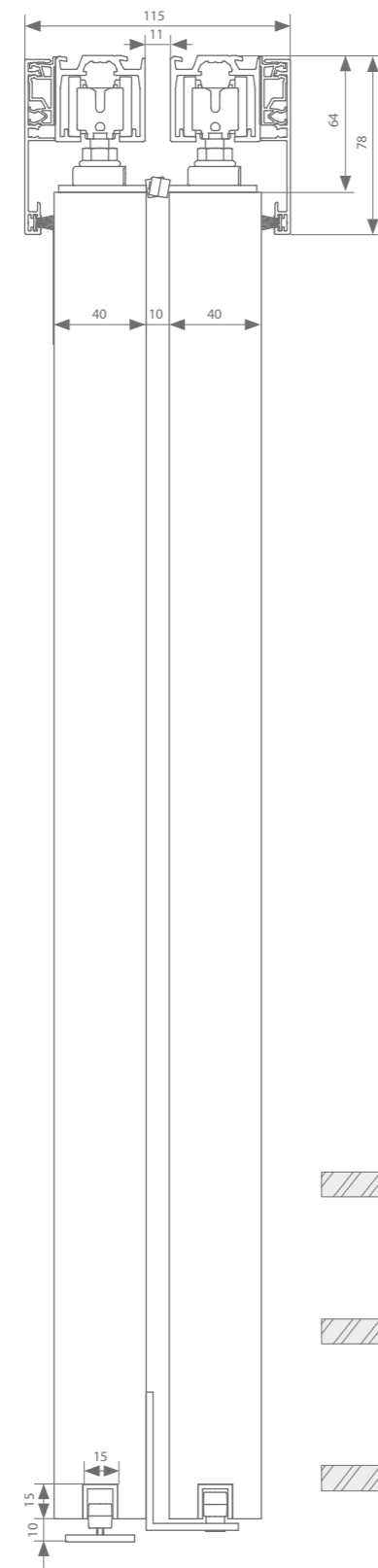

Parallel ceiling mount 2



Height adjustment: + - 4 mm

Profiles

	Max. door width	Length			
2 x running track	667 mm	2000 mm	AAA.11000200.02	AAA.11000200.07	AAA.11000200.05
	1000 mm	3000 mm	AAA.11000300.02	AAA.11000300.07	AAA.11000300.05
	1334 mm	4000 mm	AAA.11000400.02	AAA.11000400.07	AAA.11000400.05
	2000 mm	6000 mm	AAA.11000600.02	AAA.11000600.07	AAA.11000600.05
2x ESSI®-module (optional)		100 mm	AAA.11010010.02	AAA.11010010.07	AAA.11010010.05
2 x cover profile	667 mm	2000 mm	AAA.12000200.02	AAA.12000200.07	AAA.12000200.05
	1000 mm	3000 mm	AAA.12000300.02	AAA.12000300.07	AAA.12000300.05
	1334 mm	4000 mm	AAA.12000400.02	AAA.12000400.07	AAA.12000400.05
	2000 mm	6000 mm	AAA.12000600.02	AAA.12000600.07	AAA.12000600.05
+ narrow clips 1 per metre of cover profile		100 mm		AAA.12010010.07	
2 x seal	667 mm	2000 mm	AAA.12010200.02	AAA.12010200.07	
	1000 mm	3000 mm	AAA.12010300.02	AAA.12010300.07	
	1334 mm	4000 mm	AAA.12010400.02	AAA.12010400.07	
	2000 mm	6000 mm	AAA.12010600.02	AAA.12010600.07	
2 x bottom guiding track	1000 mm	1000 mm	AAA.15000100.00		
	1250 mm	1250 mm	AAA.15000125.00		
	1500 mm	1500 mm	AAA.15000150.00		
	2000 mm	2000 mm	AAA.15000200.00		
	3000 mm	3000 mm	AAA.15000300.00		
	6000 mm	6000 mm	AAA.15000600.00		

Fittings selection

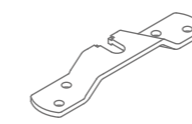



Transverse suspension		Min. door width	Min. door width ESSI	Reference
With 2 stoppers	2 x necessary	330 mm	424 mm	AAA.20000000.00
With double-action softclose	2 x necessary	661 mm	693 mm	AAA.20020000.00
+ 2 x parallel	1 x necessary			AAA.20002000.00

Every fitting set comes with all the rollers or softclose mechanisms, suspension, guiding systems and stoppers you need.

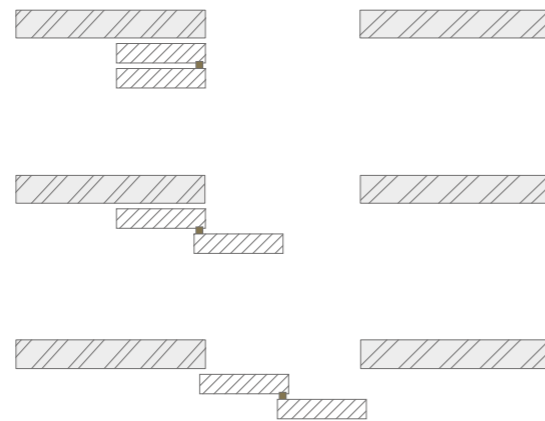
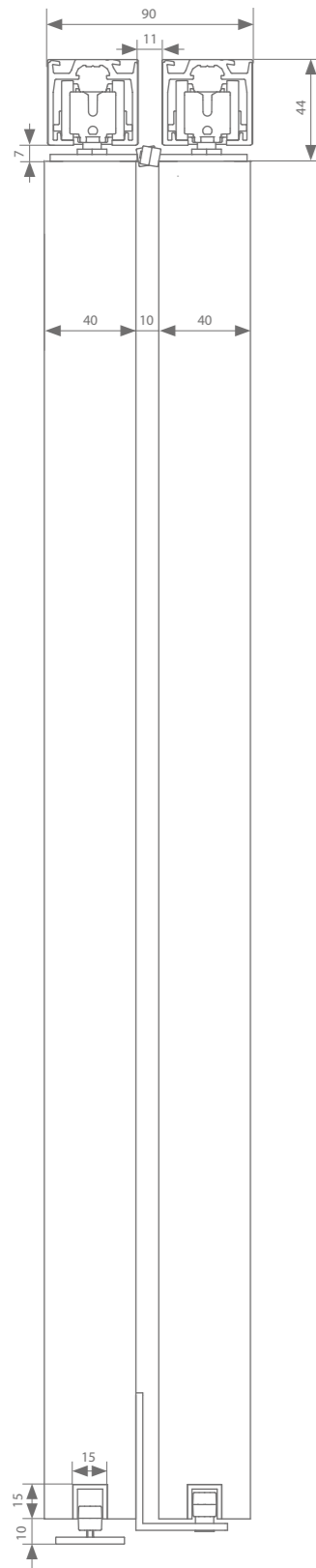
Technical drawings



Profiles

	Max. door width	Length			
2 x running track	667 mm	2000 mm	AAA.11000200.02	AAA.11000200.07	AAA.11000200.05
	1000 mm	3000 mm	AAA.11000300.02	AAA.11000300.07	AAA.11000300.05
	1334 mm	4000 mm	AAA.11000400.02	AAA.11000400.07	AAA.11000400.05
	2000 mm	6000 mm	AAA.11000600.02	AAA.11000600.07	AAA.11000600.05
2 x ESSI®-module (optional)		100 mm	AAA.11010010.02	AAA.11010010.07	AAA.11010010.05
2 x bottom guiding track	1000 mm	1000 mm	AAA.15000100.00		
	1250 mm	1250 mm	AAA.15000125.00		
	1500 mm	1500 mm	AAA.15000150.00		
	2000 mm	2000 mm	AAA.15000200.00		
	3000 mm	3000 mm	AAA.15000300.00		
	6000 mm	6000 mm	AAA.15000600.00		

Fittings selection

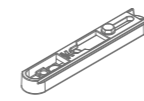

Transverse suspension			Min. door width	Min. door width ESSI	Reference	
	Manual-Fix	With 2 stoppers	2 x necessary	345 mm	446 mm	AAA.20100000.00
		Double-action softclose	2 x necessary	672 mm	710 mm	AAA.20120000.00
	Auto-Fix	With 2 stoppers	2 x necessary	345 mm	446 mm	AAA.20200000.00
		Double-action softclose	2 x necessary	672 mm	710 mm	AAA.20220000.00
+ 2 x parallel			1 x necessary			AAA.20002000.00

Every fitting set comes with all the rollers or softclose mechanisms, suspension, guiding systems and stoppers you need.

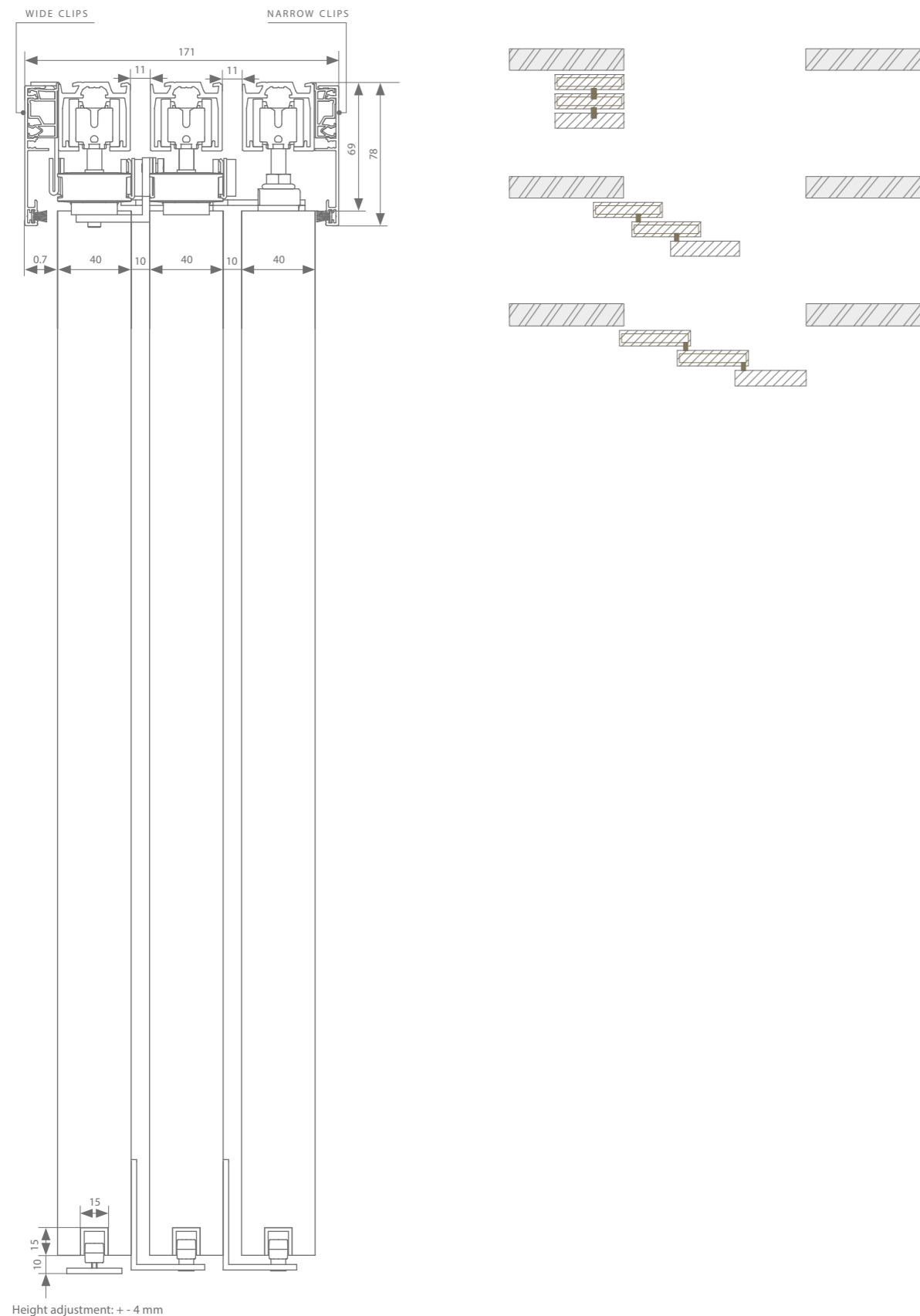
Technical drawings



Profiles

	Max. door width	Length			
3 x running track	500 mm	2000 mm	AAA.11000200.02	AAA.11000200.07	AAA.11000200.05
	750 mm	3000 mm	AAA.11000300.02	AAA.11000300.07	AAA.11000300.05
	1000 mm	4000 mm	AAA.11000400.02	AAA.11000400.07	AAA.11000400.05
	1500 mm	6000 mm	AAA.11000600.02	AAA.11000600.07	AAA.11000600.05
3x ESSI®-module (optional)		100 mm	AAA.11010010.02	AAA.11010010.07	AAA.11010010.05
2 x cover profile	500 mm	2000 mm	AAA.12000200.02	AAA.12000200.07	AAA.12000200.05
	750 mm	3000 mm	AAA.12000300.02	AAA.12000300.07	AAA.12000300.05
	1000 mm	4000 mm	AAA.12000400.02	AAA.12000400.07	AAA.12000400.05
	1500 mm	6000 mm	AAA.12000600.02	AAA.12000600.07	AAA.12000600.05
+ narrow clips 1 per metre of cover profile		100 mm		AAA.12010010.07	
+ wide clips 1 per metre of cover profile		100 mm 1000 mm		AAA.12020010.07 AAA.12020100.07	
2 x seal	500 mm	2000 mm	AAA.12010200.02	AAA.12010200.07	
	750 mm	3000 mm	AAA.12010300.02	AAA.12010300.07	
	1000 mm	4000 mm	AAA.12010400.02	AAA.12010400.07	
	1500 mm	6000 mm	AAA.12010600.02	AAA.12010600.07	
3 x bottom guiding track	1000 mm	1000 mm	AAA.15000100.00		
	1250 mm	1250 mm	AAA.15000125.00		
	1500 mm	1500 mm	AAA.15000150.00		
	2000 mm	2000 mm	AAA.15000200.00		
	3000 mm	3000 mm	AAA.15000300.00		
	6000 mm	6000 mm	AAA.15000600.00		

Fittings selection

	Transverse suspension	Min. door width	Min. door width ESSI	Length	Reference
	3 x telescopic	1 x necessary	426 mm	472 mm	AAA.20005000.00
	Belt	Min. belt length = (4 x door width) + 400 mm		50 m 20 m 10 m	AK9.709.050 AK9.709.020 AK9.709.010

Motorised set*



	Transverse suspension with motor	Min. door width	Min. door width ESSI	Length	Reference
Fittings	A-slide** (max. 40 kg/door, 1 x necessary)	742 mm	805 mm		AAA.20033000.00
Belt	Min. belt length = (12 x door width) + 600 mm			50 m	AK9.709.050
				20 m	AK9.709.020
				10 m	AK9.709.010
Remote control	for 1 channel				AM3.100.104.61
	for 4 channels				AM3.100.104.64

* see p.68 for more information Every fitting set comes with all the rollers or softclose mechanisms, suspension, guiding systems and stoppers you need.
** Cannot be combined with cover profiles and end caps

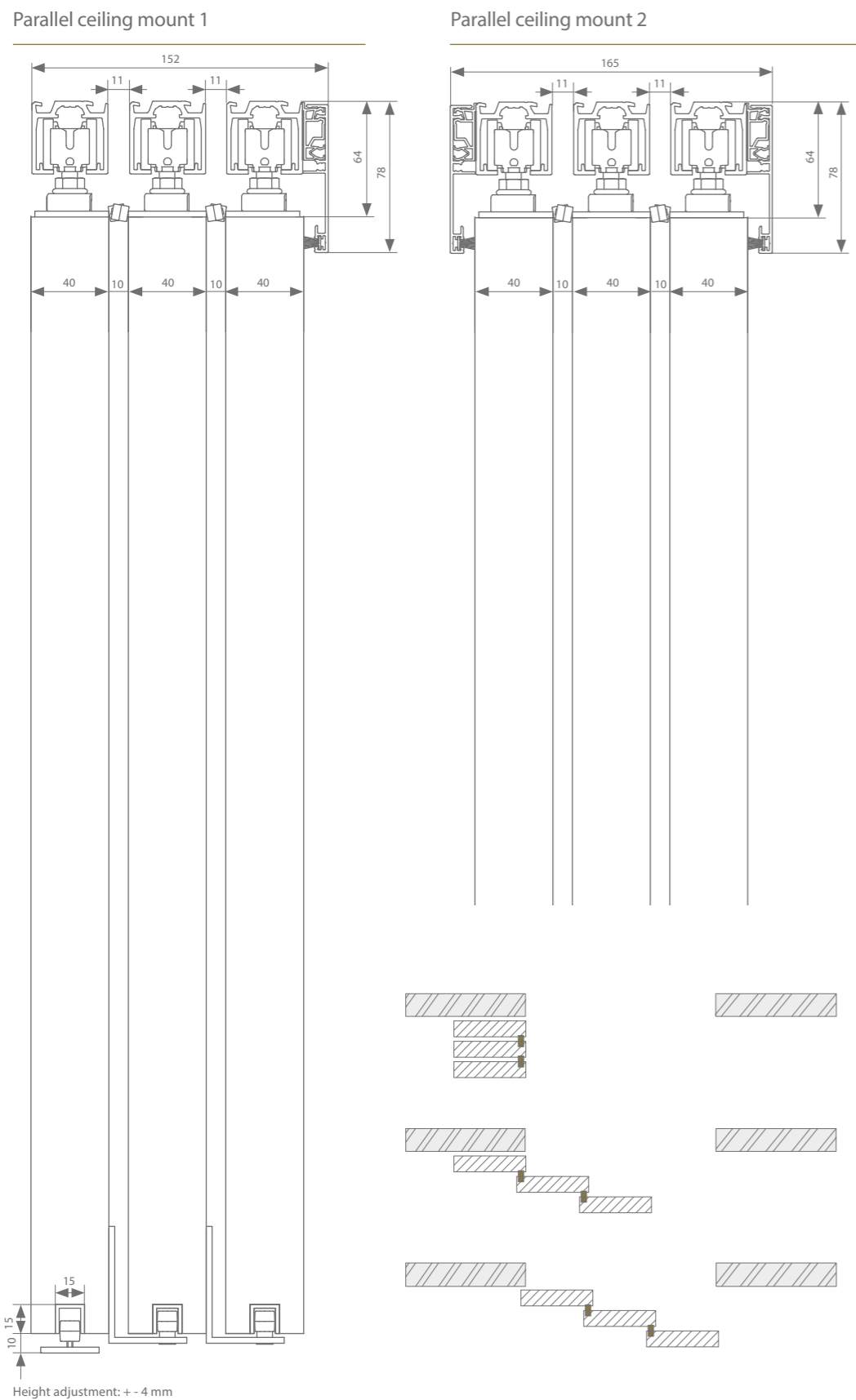
Technical drawings



Profiles

	Max. door width	Length			
3 x running track	500 mm	2000 mm	AAA.11000200.02	AAA.11000200.07	AAA.11000200.05
	750 mm	3000 mm	AAA.11000300.02	AAA.11000300.07	AAA.11000300.05
	1000 mm	4000 mm	AAA.11000400.02	AAA.11000400.07	AAA.11000400.05
	1500 mm	6000 mm	AAA.11000600.02	AAA.11000600.07	AAA.11000600.05
3xESSI®-module (optional)		100 mm	AAA.11010010.02	AAA.11010010.07	AAA.11010010.05
2 x cover profile	500 mm	2000 mm	AAA.12000200.02	AAA.12000200.07	AAA.12000200.05
	750 mm	3000 mm	AAA.12000300.02	AAA.12000300.07	AAA.12000300.05
	1000 mm	4000 mm	AAA.12000400.02	AAA.12000400.07	AAA.12000400.05
	1500 mm	6000 mm	AAA.12000600.02	AAA.12000600.07	AAA.12000600.05
+ narrow clips 1 per metre of cover profile		100 mm		AAA.12010010.07	
2 x seal	500 mm	2000 mm	AAA.12010200.02	AAA.12010200.07	
	750 mm	3000 mm	AAA.12010300.02	AAA.12010300.07	
	1000 mm	4000 mm	AAA.12010400.02	AAA.12010400.07	
	1500 mm	6000 mm	AAA.12010600.02	AAA.12010600.07	
3 x bottom guiding track	1000 mm	1000 mm	AAA.15000100.00		
	1250 mm	1250 mm	AAA.15000125.00		
	1500 mm	1500 mm	AAA.15000150.00		
	2000 mm	2000 mm	AAA.15000200.00		
	3000 mm	3000 mm	AAA.15000300.00		
	6000 mm	6000 mm	AAA.15000600.00		

Fittings selection





Transverse suspension		Min. door width	Min. door width ESSI	Reference
With 2 stoppers	3 x necessary	330 mm	424 mm	AAA.20000000.00
With double-action softclose	3 x necessary	661 mm	693 mm	AAA.20020000.00
+ 3 x parallel	1 x necessary			AAA.20004000.00

Every fitting set comes with all the rollers or softclose mechanisms, suspension, guiding systems and stoppers you need.

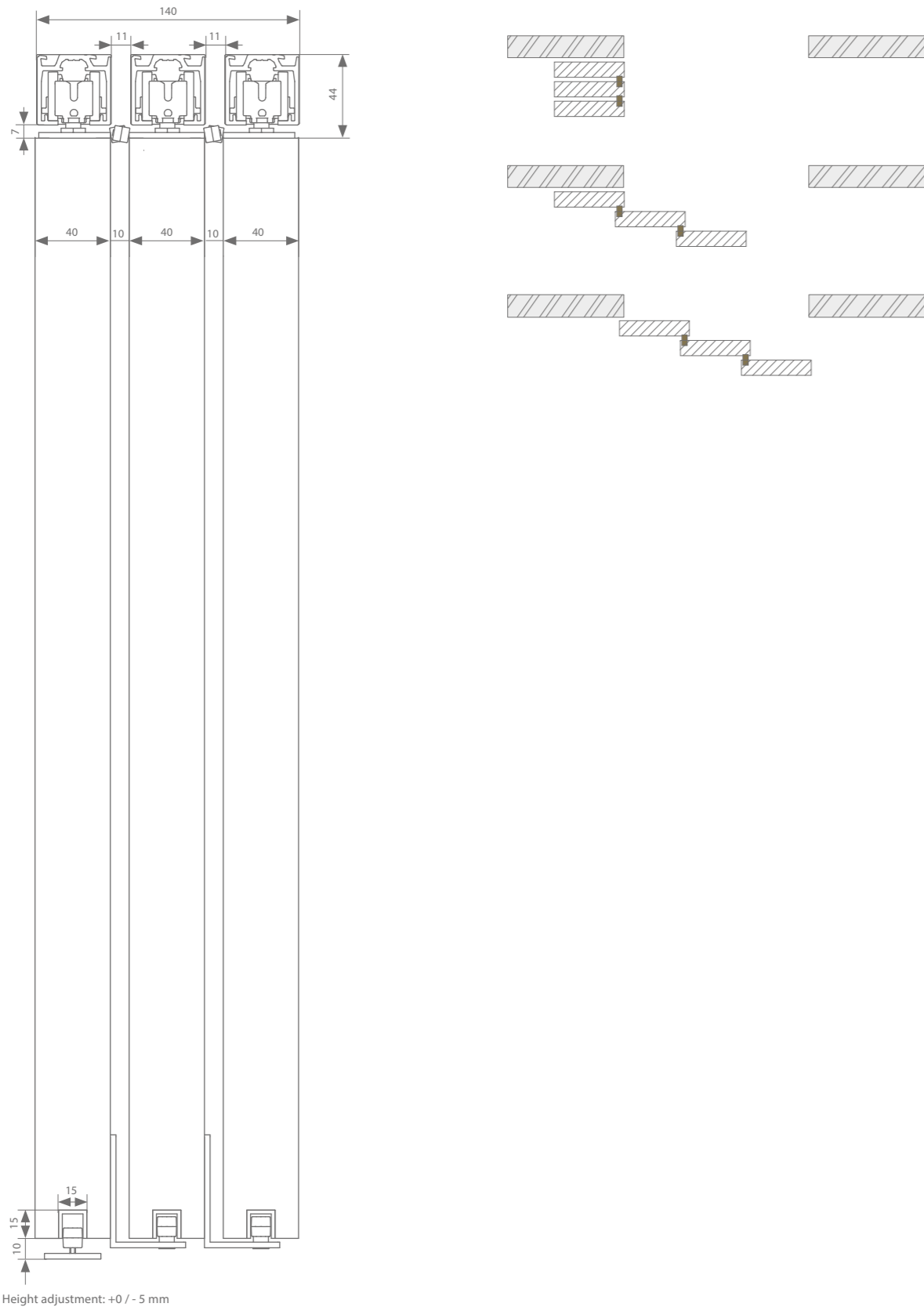
Technical drawings



Profiles

	Max. door width	Length			
3 x running track	500 mm	2000 mm	AAA.11000200.02	AAA.11000200.07	AAA.11000200.05
	750 mm	3000 mm	AAA.11000300.02	AAA.11000300.07	AAA.11000300.05
	1000 mm	4000 mm	AAA.11000400.02	AAA.11000400.07	AAA.11000400.05
	1500 mm	6000 mm	AAA.11000600.02	AAA.11000600.07	AAA.11000600.05
3 x ESSI®-module (optional)		100 mm	AAA.11010010.02	AAA.11010010.07	AAA.11010010.05
3 x bottom guiding track	1000 mm	1000 mm	AAA.15000100.00		
	1250 mm	1250 mm	AAA.15000125.00		
	1500 mm	1500 mm	AAA.15000150.00		
	2000 mm	2000 mm	AAA.15000200.00		
	3000 mm	3000 mm	AAA.15000300.00		
	6000 mm	6000 mm	AAA.15000600.00		

Fittings selection

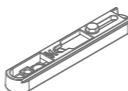
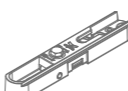
Transverse suspension			Min. door width	Min. door width ESSI	Reference
	Manual-Fix	With 2 stoppers 3 x necessary	345 mm	446 mm	AAA.20100000.00
		Double-action softclose 3 x necessary	672 mm	710 mm	AAA.20120000.00
	Auto-Fix	With 2 stoppers 3 x necessary	345 mm	446 mm	AAA.20200000.00
		Double-action softclose 3 x necessary	672 mm	710 mm	AAA.20220000.00
+ 3 x parallel		1 x necessary			AAA.20004000.00

Every fitting set comes with all the rollers or softclose mechanisms, suspension, guiding systems and stoppers you need.

a-slide MOTORISATION

The a-slide is the intelligent motorisation system for Xperta. The motor is mounted at the end of the Xperta running track and connected to the door leaf via a belt. One single a-slide can drive a single door, a symmetrical double door or a telescopic system, with a maximum combined door weight of 120 kg.

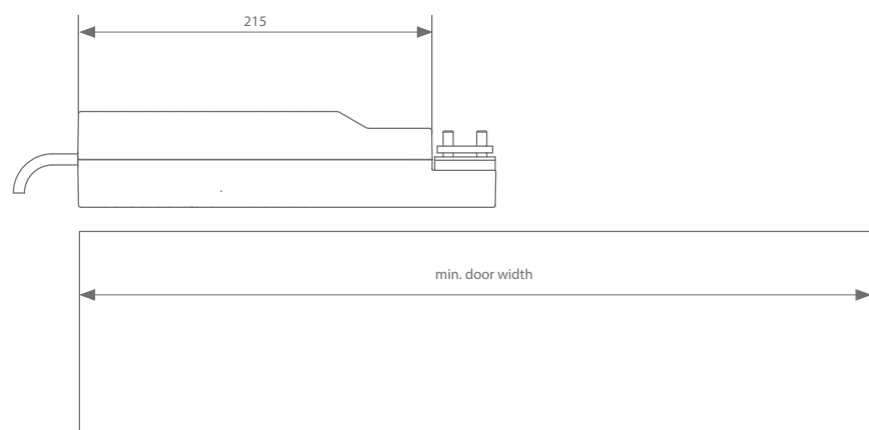

The a-slide can be operated with a wired push button or wirelessly with the optional remote control. When connected to a suitable switch module, the motor can also be integrated into a home automation system. Once connected, the motor is immediately ready for use. The handy ARLU® app allows for easy adjustment of the automatic sliding door settings to any situation.



DOWNLOAD APP

Max. weight	120 kg
Connection	230V AC ~50HZ / 50W
Movement	Straight-sliding Symmetrical Telescopic
Remote controls	Switching via phase wire or remote control ARLU-app (Bluetooth and WiFi-interface)
Mode	Standard Self-closing
Speed	Adjustable up to 30 cm/s

Basic motorised set*

		Length	Reference
Fittings	A-slide		AAA.20030000.00
Belt	Min. belt length = (4 x door width) + 200 mm	50 m	AK9.709.050
		20 m	AK9.709.020
		10 m	AK9.709.010
Remote control	for 1 channels		AM3.100.104.61
	for 4 channels		AM3.100.104.64

Every fitting set comes with all the rollers or softclose mechanisms, suspension, guiding systems and stoppers you need.
* Items for symmetric and telescopic doors, see previous pages..

02

XPERTA GLASS

As a specialist in sliding door systems, ARLU® has provided as well solutions for glass sliding doors in the Xperta range. Market needs have again been taken into account here, and benefits such as the double-action silent softclose feature have been included. The glass panels are suspended from a unique glass clamp that is suitable for glass thicknesses of 8, 10 and 12 mm.



argenta xperta glass
why choose Xperta?

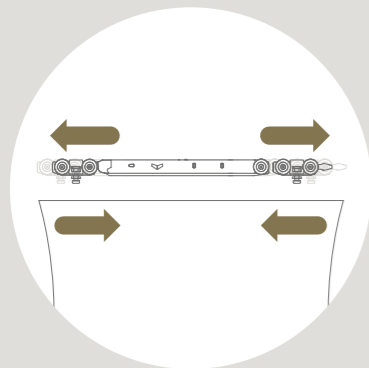

**DOUBLE-ACTION
SOFTCLOSE**

for gentle opening and closing of doors. The compact design makes it suitable for extremely narrow doors.

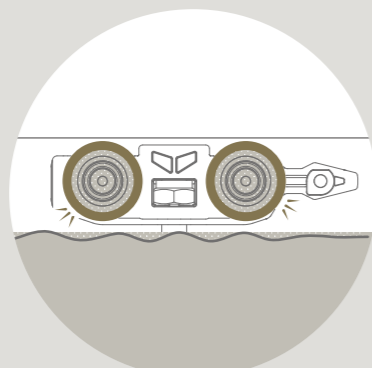

**MINIMUM ROLLING
RESISTANCE,
MAXIMUM NOISE
REDUCTION**

thanks to wheels with a hard running surface and soft core.

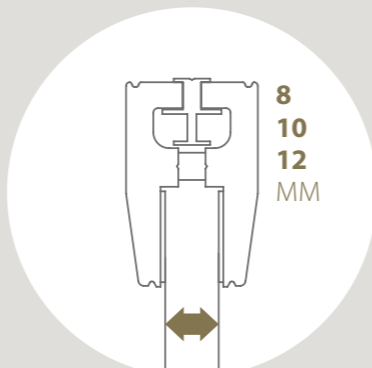

**UNIVERSAL
GLASS CLAMP**

for 8, 10 or 12 mm glass

Quick (dis)assembly thanks to the ESSI® module

Separate activator channel

TIP



You can use connection piece AAA.11011000.00 to connect two profiles in line.

Easy clip-in system

Soft U-guide

Xperta is a universal solution for glass doors up to 100 kg. The unique running track and silent rollers ensure optimal movement of every sliding door. Xperta can be mounted with matching wall and cover profiles, or with the running track directly under the ceiling.

The Xperta invisible running track allows for an even sleeker finish in a suspended ceiling.

Available in three colours
F1 anodised aluminium, black
and white textured coating





Xperta SINGLE DOOR

Xperta sliding doors stand out for their quiet operation, versatility, intuitive installation, sleek design and durability. The double-action softclose makes the operation even more comfortable. Glass panels of 8, 10 and 12 mm can be applied thanks to the universal glass clamps. These clamps can be hidden behind a cover profile with end pieces.

PROFILE LENGTH

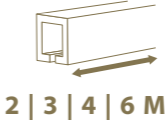

2 | 3 | 4 | 6 M

INSTALLATION



DOOR WEIGHT



MAX.
100
KG



anodised aluminium



black textured coating
RAL 9005



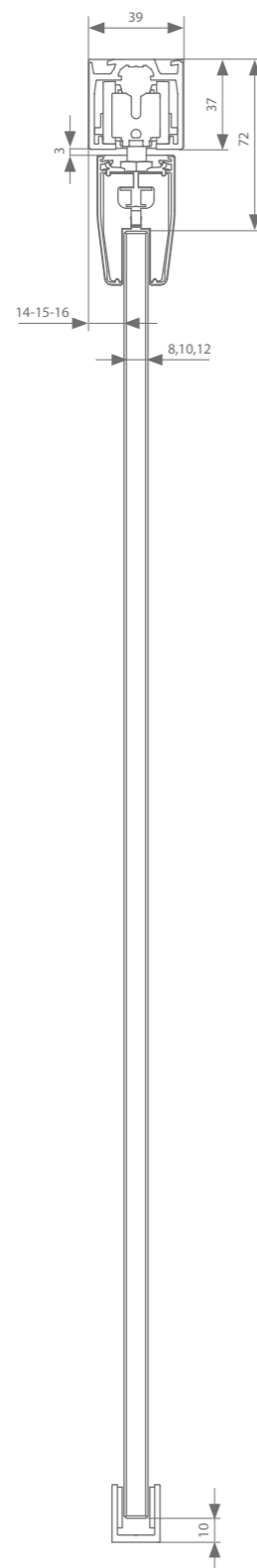

white textured coating
RAL 9016

Technical drawings



Height adjustment: + 0 / - 5 mm

Profiles

	Max. door width	Length			
Running track	1000 mm	2000 mm	AAA.11000200.02	AAA.11000200.07	AAA.11000200.05
	1500 mm	3000 mm	AAA.11000300.02	AAA.11000300.07	AAA.11000300.05
	2000 mm	4000 mm	AAA.11000400.02	AAA.11000400.07	AAA.11000400.05
	3000 mm	6000 mm	AAA.11000600.02	AAA.11000600.07	AAA.11000600.05
ESSI®-module (optional)		100 mm	AAA.11010010.02	AAA.11010010.07	AAA.11010010.05
Set of end caps			AAA.91000000.02	AAA.91000000.07	AAA.91000000.05
Cover profile	1000 mm	2000 mm	AAB.12100200.02	AAB.12100200.07	AAB.12100200.05
	1500 mm	3000 mm	AAB.12100300.02	AAB.12100300.07	AAB.12100300.05
	2000 mm	4000 mm	AAB.12100400.02	AAB.12100400.07	AAB.12100400.05
	3000 mm	6000 mm	AAB.12100600.02	AAB.12100600.07	AAB.12100600.05
Glass thickness					
End cap glass clamp		8 mm	AAB.92110000.02	AAB.92110000.07	AAB.92110000.05
		10 mm	AAB.92120000.02	AAB.92120000.07	AAB.92120000.05
		12 mm	AAB.92130000.02	AAB.92130000.07	AAB.92130000.05

Fittings selection

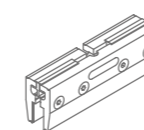

Compact suspension	Min. door width	Min. door width ESSI	Reference
With 2 stoppers	367 mm	453 mm	AAB.20000000.00
With double-action softclose	611 mm	670 mm	AAB.20020000.00

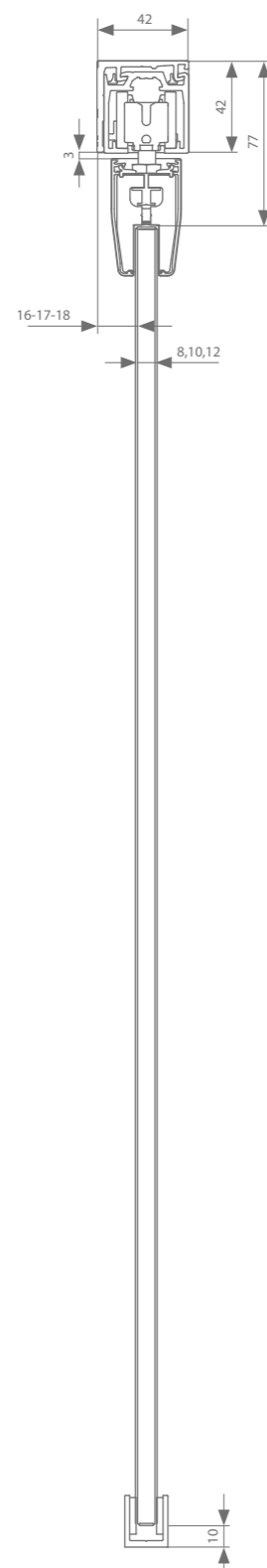

Every fitting set comes with all the rollers or softclose mechanisms, suspension, guiding systems and stoppers you need.

Technical drawings



Height adjustment: + 0 / - 5 mm

Profiles

	Max. door width	Length			
Running track	1000 mm	2000 mm	AAA.11000200.02	AAA.11000200.07	AAA.11000200.05
	1500 mm	3000 mm	AAA.11000300.02	AAA.11000300.07	AAA.11000300.05
	2000 mm	4000 mm	AAA.11000400.02	AAA.11000400.07	AAA.11000400.05
	3000 mm	6000 mm	AAA.11000600.02	AAA.11000600.07	AAA.11000600.05
ESSI®-module (optional)		100 mm	AAA.11010010.02	AAA.11010010.07	AAA.11010010.05
Wall profile	1000 mm	2000 mm	AAB.13200200.02	AAB.13200200.07	AAB.13200200.05
	1500 mm	3000 mm	AAB.13200300.02	AAB.13200300.07	AAB.13200300.05
	2000 mm	4000 mm	AAB.13200400.02	AAB.13200400.07	AAB.13200400.05
	3000 mm	6000 mm	AAB.13200600.02	AAB.13200600.07	AAB.13200600.05
+ mounting set			AAA.13010000.07		
Set of end caps			AAB.93200000.02	AAB.93200000.07	AAB.93200000.05
Cover profile	1000 mm	2000 mm	AAB.12100200.02	AAB.12100200.07	AAB.12100200.05
	1500 mm	3000 mm	AAB.12100300.02	AAB.12100300.07	AAB.12100300.05
	2000 mm	4000 mm	AAB.12100400.02	AAB.12100400.07	AAB.12100400.05
	3000 mm	6000 mm	AAB.12100600.02	AAB.12100600.07	AAB.12100600.05
Glass thickness					
End cap glass clamp		8 mm	AAB.92110000.02	AAB.92110000.07	AAB.92110000.05
		10 mm	AAB.92120000.02	AAB.92120000.07	AAB.92120000.05
		12 mm	AAB.92130000.02	AAB.92130000.07	AAB.92130000.05

Fittings selection

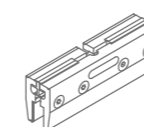

Compact suspension	Min. door width	Min. door width ESSI	Reference
With 2 stoppers	367 mm	453 mm	AAB.20000000.00
With double-action softclose	611 mm	670 mm	AAB.20020000.00

Every fitting set comes with all the rollers or softclose mechanisms, suspension, guiding systems and stoppers you need.



Xperta FLUSH INTO CEILING

The Xperta invisible glass is the ultimate solution for ceiling high applications where the profile is seamlessly integrated into a suspended ceiling. The profile can be finished with standard plasterboard, or whatever skirting that might be chosen.

PROFILE LENGTH

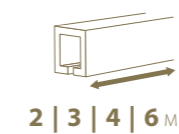

2 | 3 | 4 | 6 M

INSTALLATION



DOOR WEIGHT



grey anodised
aluminium

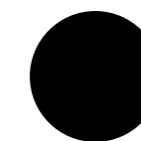

black anodised
aluminium



white matte coating
RAL 9016

Technical drawings

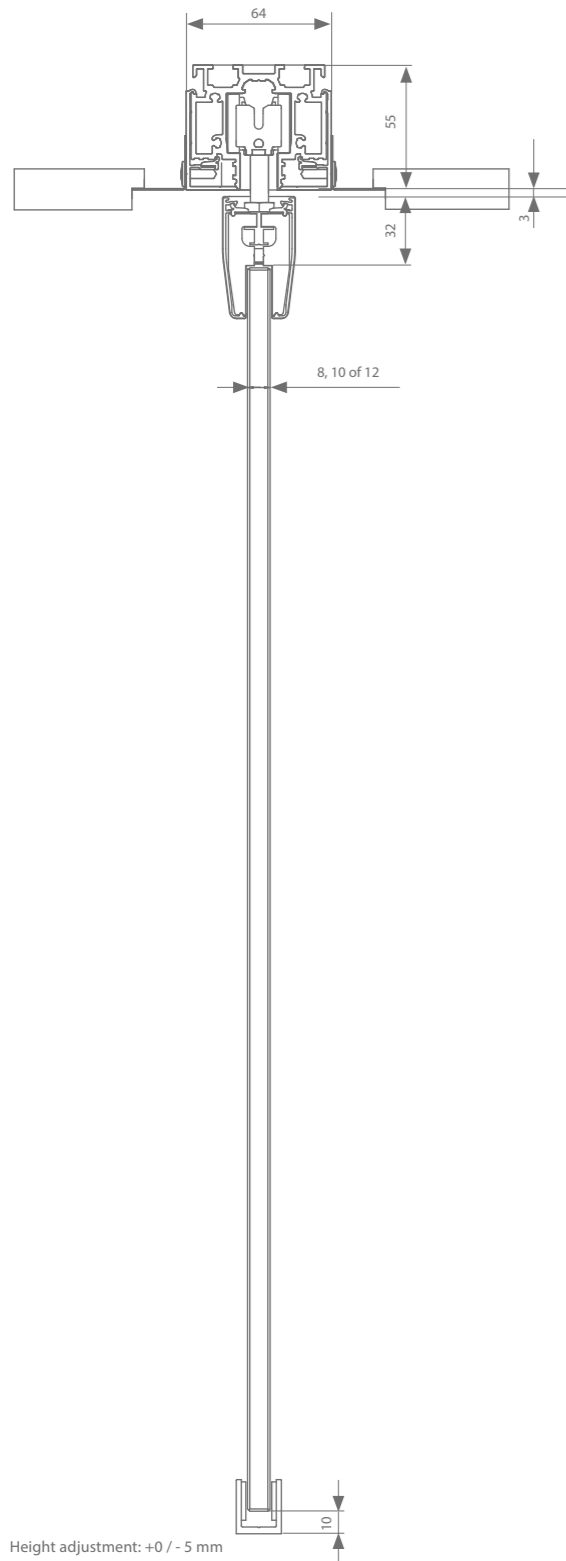

For suspended ceiling (1+2)

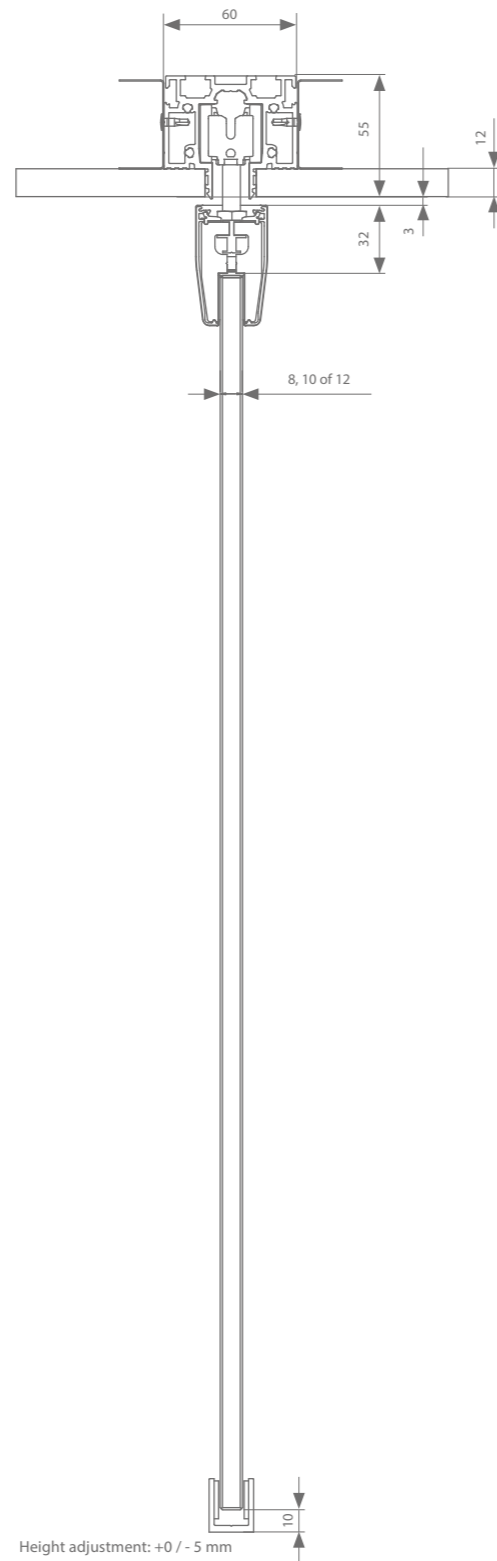

For plasterboard (1)



Profiles

	Max. door width	Length			
Running track (1)	1000 mm	2000 mm	AAA.11100200.02	AAA.11100200.07	AAA.11100200.05
	1500 mm	3000 mm	AAA.11100300.02	AAA.11100300.07	AAA.11100300.05
	2000 mm	4000 mm	AAA.11100400.02	AAA.11100400.07	AAA.11100400.05
	3000 mm	6000 mm	AAA.11100600.02	AAA.11100600.07	AAA.11100600.05
ESSI®-module (optional)		100 mm	AAA.11110010.02	AAA.11110010.07	AAA.11110010.05
2 x extra cover profile for suspended ceilings (2)	1000 mm	2000 mm			AAA.11120200.05
	1500 mm	3000 mm			AAA.11120300.05
	2000 mm	4000 mm			AAA.11120400.05
	3000 mm	6000 mm			AAA.11120600.05
+ 2 x for ESSI					AAA.11113010.05
Cover profile	1000 mm	2000 mm	AAB.12100200.02	AAB.12100200.07	AAB.12100200.05
	1500 mm	3000 mm	AAB.12100300.02	AAB.12100300.07	AAB.12100300.05
	2000 mm	4000 mm	AAB.12100400.02	AAB.12100400.07	AAB.12100400.05
	3000 mm	6000 mm	AAB.12100600.02	AAB.12100600.07	AAB.12100600.05
End cap glass clamp	Glass thickness				
		8 mm	AAB.92110000.02	AAB.92110000.07	AAB.92110000.05
		10 mm	AAB.92120000.02	AAB.92120000.07	AAB.92120000.05
	12 mm	AAB.92130000.02	AAB.92130000.07	AAB.92130000.05	

* black textured coating RAL 9005, white textured coating RAL 9016

Fittings selection

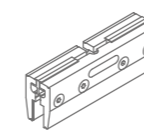

Compact suspension	Min. door width	Min. door width ESSI	Reference
With 2 stoppers	367 mm	453 mm	AAB.20000000.00
With double-action softclose	611 mm	670 mm	AAB.20020000.00

Every fitting set comes with all the rollers or softclose mechanisms, suspension, guiding systems and stoppers you need.

NOTES

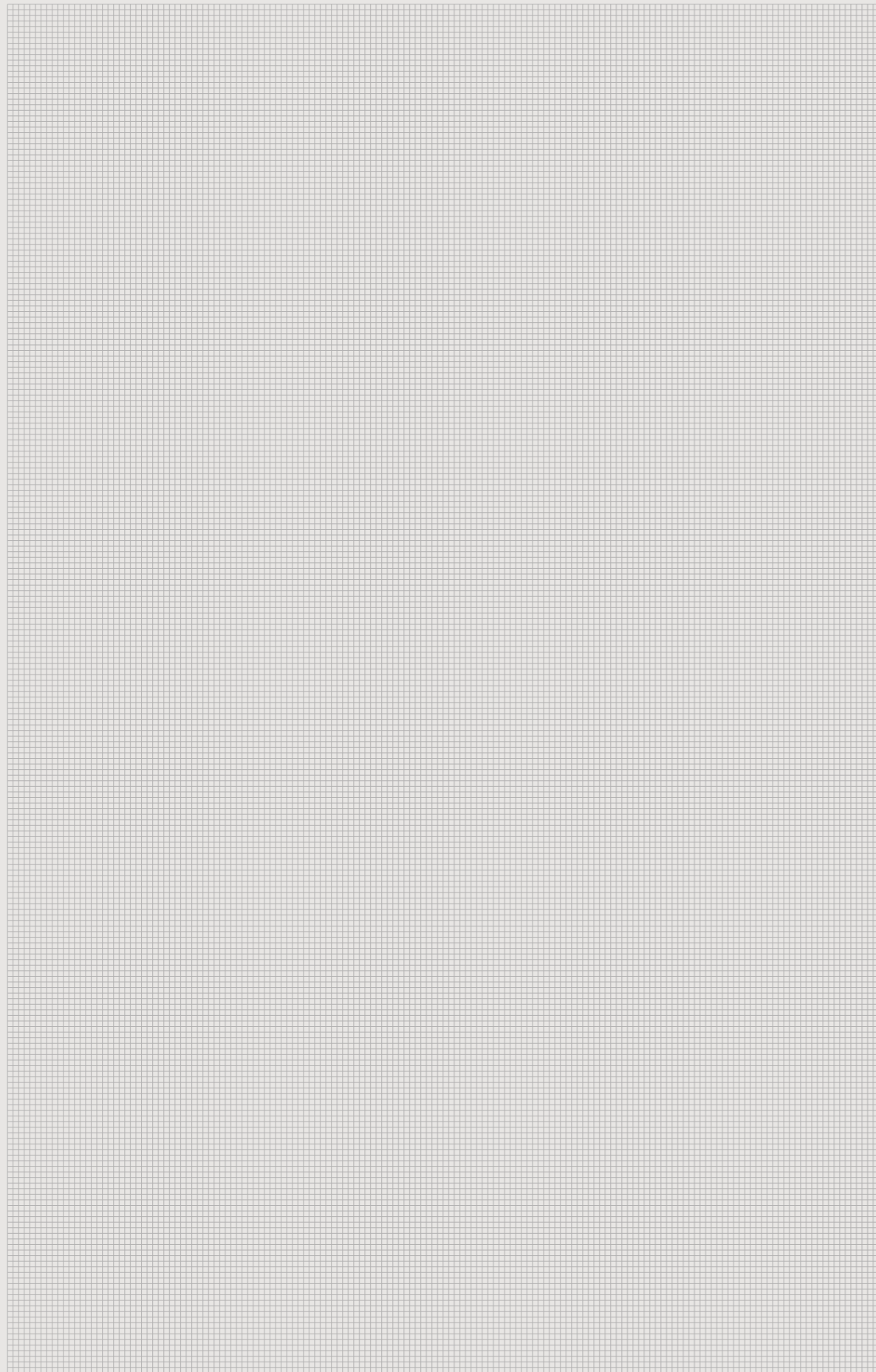

NOTES

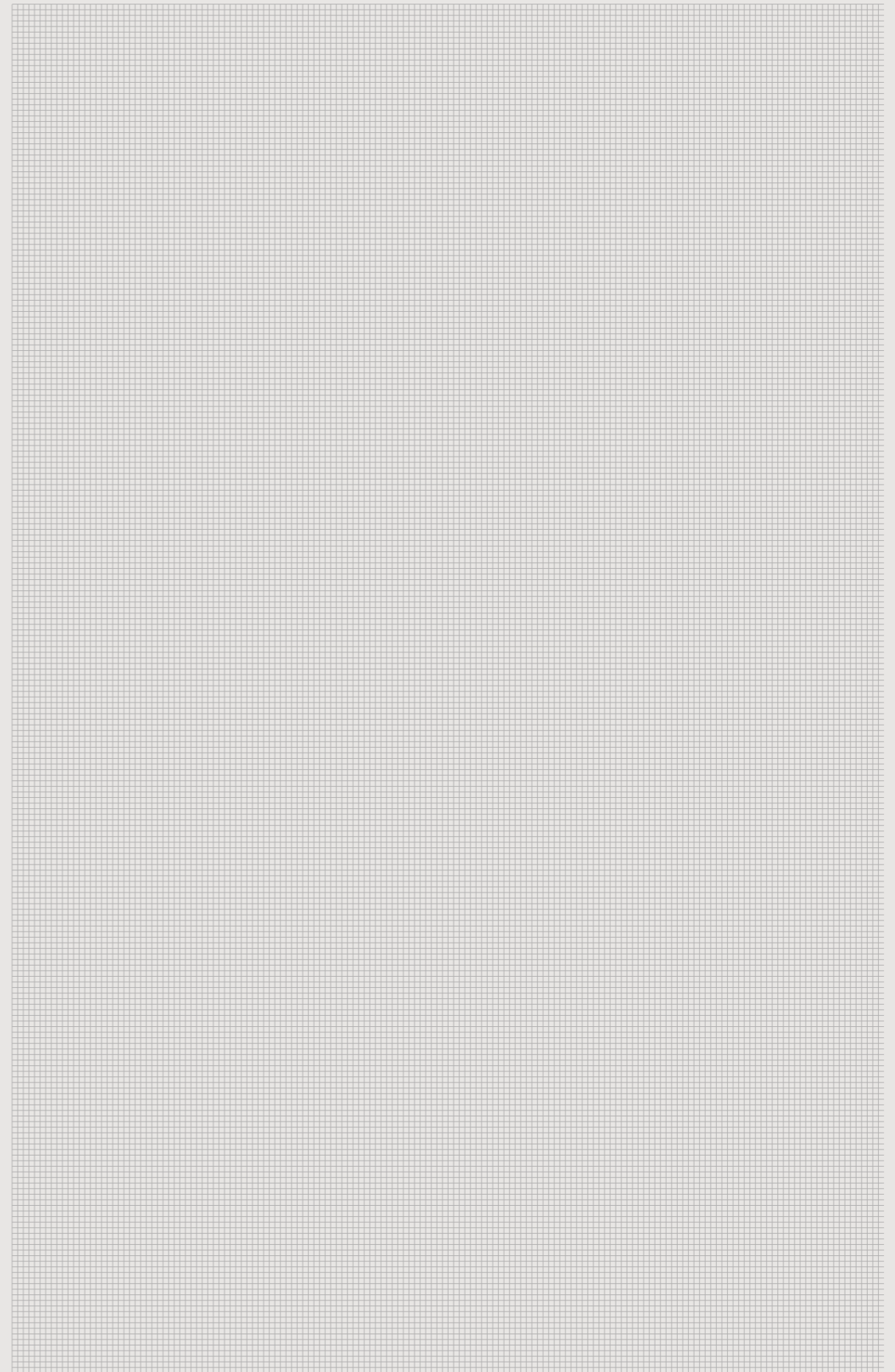



THIS BROCHURE IS UPDATED REGULARLY.
PLEASE CHECK OUR WEBSITE FOR THE LATEST AND UP TO DATE VERSION.

