



FURNITURE HARDWARE



argenta
OPENING DOORS



ALL TECHNICAL DRAWINGS ARE SHOWN IN MILLIMETRES AND ARE SUBJECT TO CHANGE BY ARLU.

ARLU, THE REFERENCE FOR OPENING DOORS

ARLU® is the manufacturer behind the brand names argenta® and rob®. Argenta has been a leading brand in door hardware for over 100 years, but today it is mainly synonymous with invisible door systems.

Minimalist architecture swears by clean lines and a "back to the essence" mentality. In terms of interior doors, this results in integrated door fittings, invisible integrated techniques, door frames and skirting boards for revolving, sliding and pivoting doors.

Argenta stands for a full range of sleek interior solutions.

01

FURNITURE HARDWARE FOR WOODEN PANELS

- 4 550/560.000
- 10 sprint
- 18 format
- 22 501.000
- 26 symfo 60

02

FURNITURE HARDWARE FOR GLASS PANELS

- 34 sliding glass

01

FURNITURE HARDWARE FOR WOODEN PANELS

Our furniture hardware can be both top-hung and supported from below, and can handle all commonly used panel thicknesses. Panels can weigh up to 60 kg each, and an endless number of panels can be fitted next to each other. Extra optional colours ensure our range is widely applicable to furniture, dressing rooms and other applications.

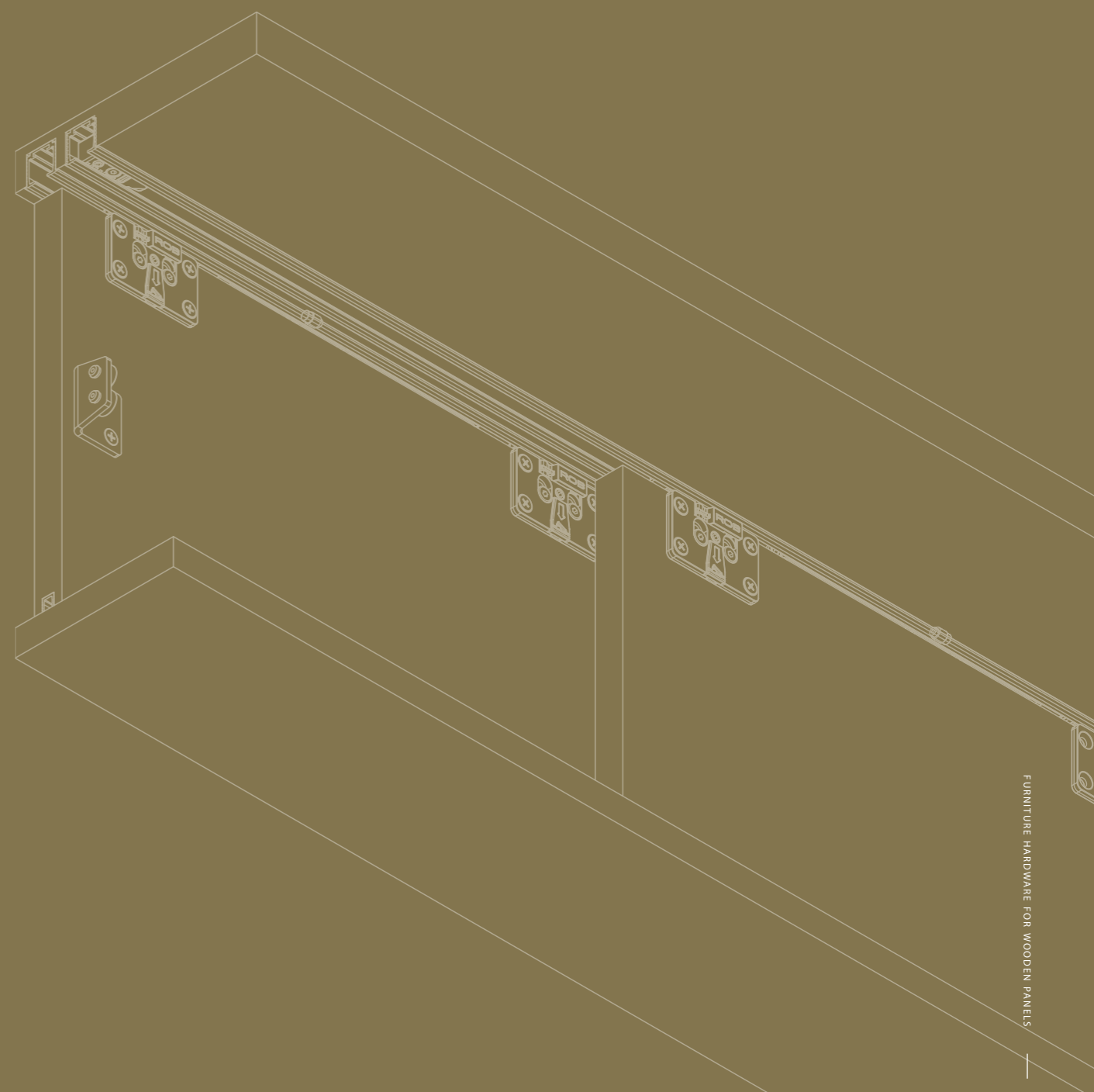

FURNITURE HARDWARE FOR WOODEN PANELS



argenta
550/560.000

The tracks used are made of either aluminium or galvanised sheet steel. A variety of single or double tracks are used to slide the doors together. The rollers in this series, are single – up to max. 20 kg per leaf – or double rollers up to max. 30 kg per leaf. They are mounted on the top edge of the doors using support plates. The rollers on ball bearings are made of plastic and are especially smooth. An alternative form of rollers for lateral mounting for panels from 18 to 48 mm is also available.



anodised
aluminium

Technical drawings

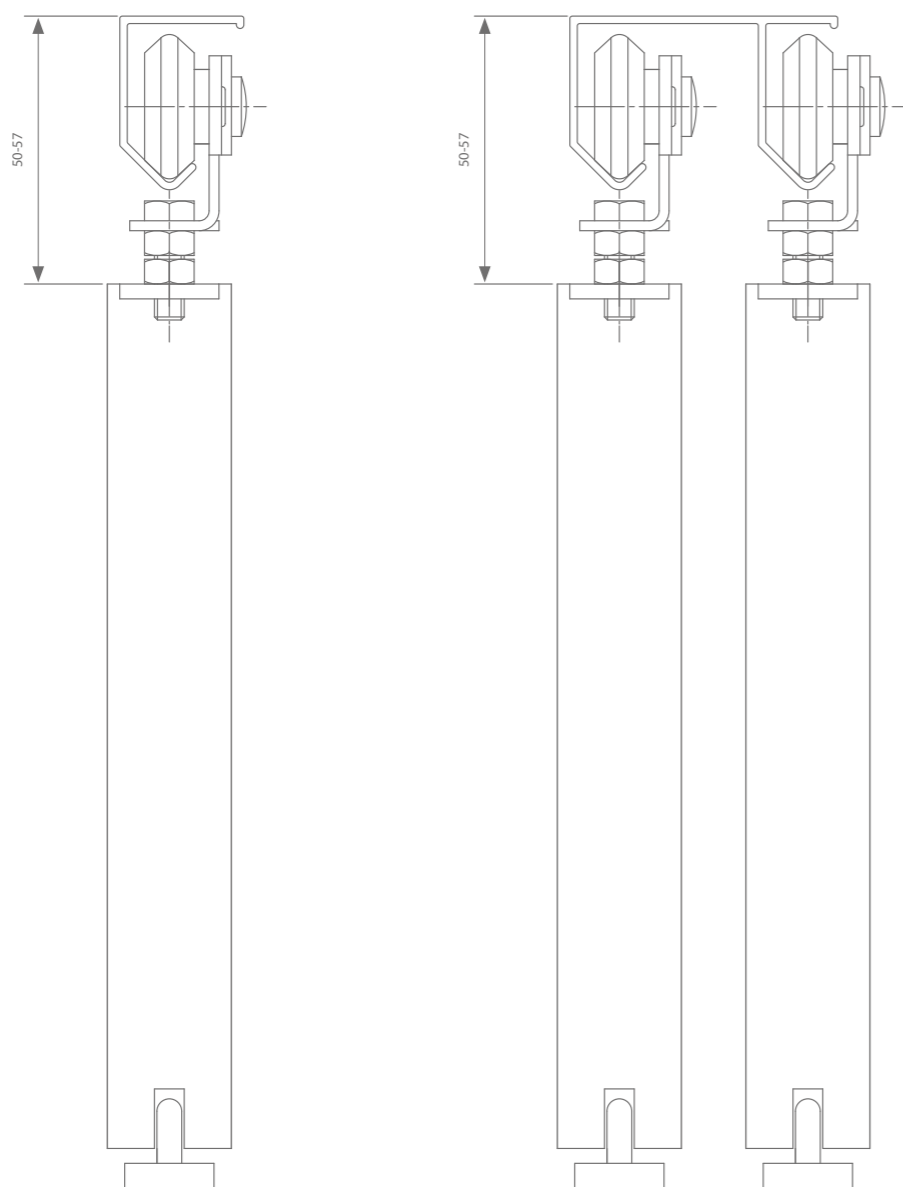

Tracks

	Max. door width	Length	Reference
Single aluminium track	1050 mm	2100 mm	550.008.210
	1500 mm	3000 mm	550.008.300
	3000 mm	6000 mm	550.008.600
Single steel track	750 mm	1500 mm	550.000.150
	1000 mm	2000 mm	550.000.200
	1500 mm	3000 mm	550.000.300
Double aluminium track	As per setup	2100 mm	560.008.210
		3000 mm	560.008.300
		6000 mm	560.008.600

Accessories selection

Max. 20 kg per panel	Reference
Fitting set with single rollers	550.100
Max. 30 kg per panel	Reference
Fitting set with double rollers	550.600

Every fitting set comes with all the rollers, suspension, guiding systems and stopper you need. One fitting set is required per door panel.

possible configurations

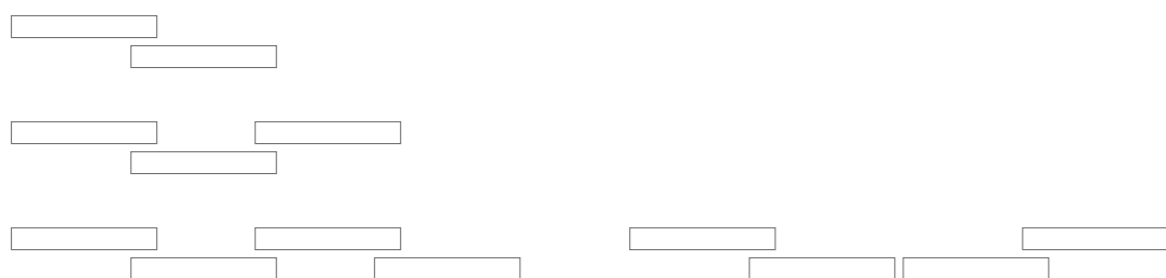

Tracks

	Max. door width	Length	Reference
Single aluminium track	1050 mm	2100 mm	550.008.210
	1500 mm	3000 mm	550.008.300
	3000 mm	6000 mm	550.008.600
Single steel track	750 mm	1500 mm	550.000.150
	1000 mm	2000 mm	550.000.200
	1500 mm	3000 mm	550.000.300

Accessories selection

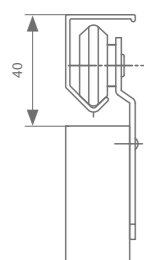

Max. 20 kg per panel

Fitting set with single rollers

550.200

Max. 30 kg per panel

Fitting set with double rollers

550.700

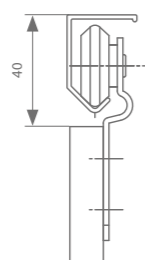

Max. 20 kg per panel

Fitting set with single rollers

560.300

Max. 30 kg per panel

Fitting set with double rollers

560.800

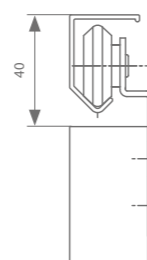

Max. 20 kg per panel

Fitting set with single rollers

560.400

Max. 30 kg per panel

Fitting set with double rollers

560.900

Every fitting set comes with all the rollers, suspension and guiding systems you need. One fitting set is required per door panel.

Tracks

	Max. door width	Length	Reference
Double aluminium track	As per setup	2100 mm	560.008.210
		3000 mm	560.008.300
		6000 mm	560.008.600

Accessories selection

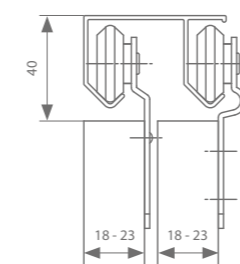

Max. 20 kg per panel

Fitting set with single rollers

550.200 560.300

Max. 30 kg per panel

Fitting set with double rollers

550.700 560.800

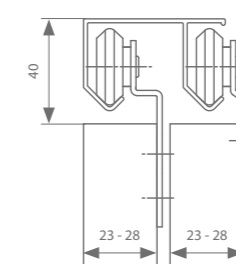

Max. 20 kg per panel

Fitting set with single rollers

560.400 550.200

Max. 30 kg per panel

Fitting set with double rollers

560.900 550.700

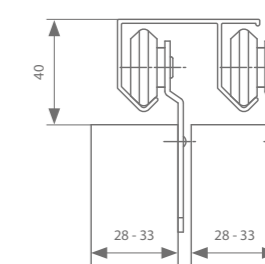

Max. 20 kg per panel

Fitting set with single rollers

550.200 550.200

Max. 30 kg per panel

Fitting set with double rollers

550.700 550.700

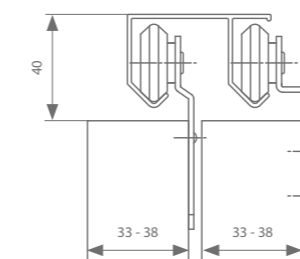

Max. 20 kg per panel

Fitting set with single rollers

550.200 560.400

Max. 30 kg per panel

Fitting set with double rollers

550.700 560.900

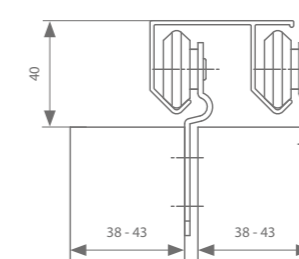

Max. 20 kg per panel

Fitting set with single rollers

560.300 550.200

Max. 30 kg per panel

Fitting set with double rollers

560.800 550.700

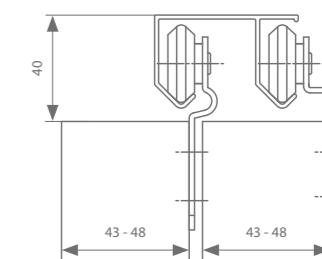

Max. 20 kg per panel

Fitting set with single rollers

560.300 560.400

Max. 30 kg per panel

Fitting set with double rollers

560.800 560.900

Every fitting set comes with all the rollers, suspension and guiding systems you need. One fitting set is required per door panel.



argenta
SPRINT

With this system, cabinet doors weighing up to 35 kg per panel can be finished in a minimalist way using a built-in top track. A bottom guide system behind the door for up to two panels sitting in front of each other or a smaller bottom guide system complete this invisible fitting. Silent operation combined with an invisible soft close guarantee an extremely comfortable experience.



anodised
aluminium

Technical drawings

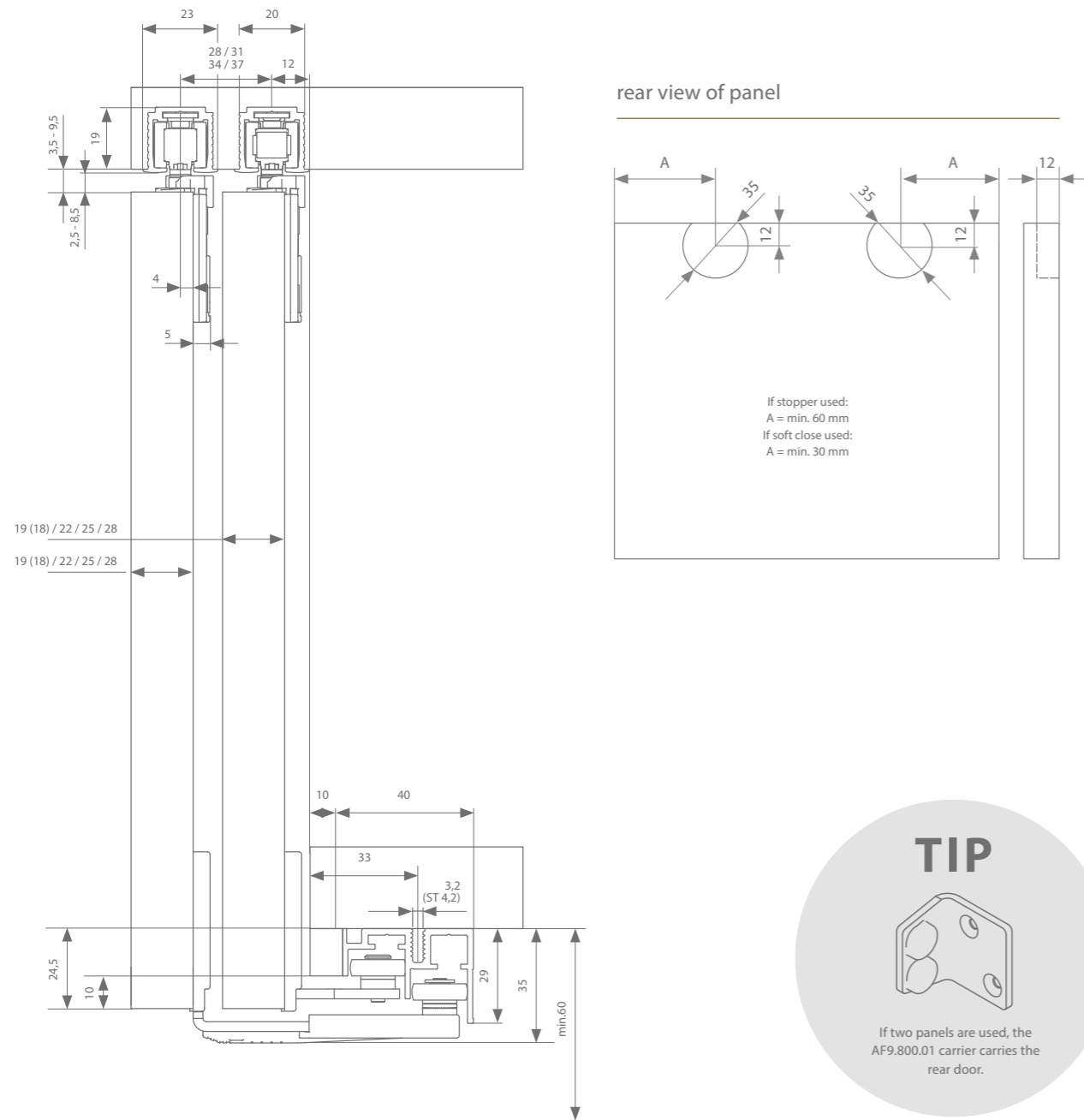

possible configurations

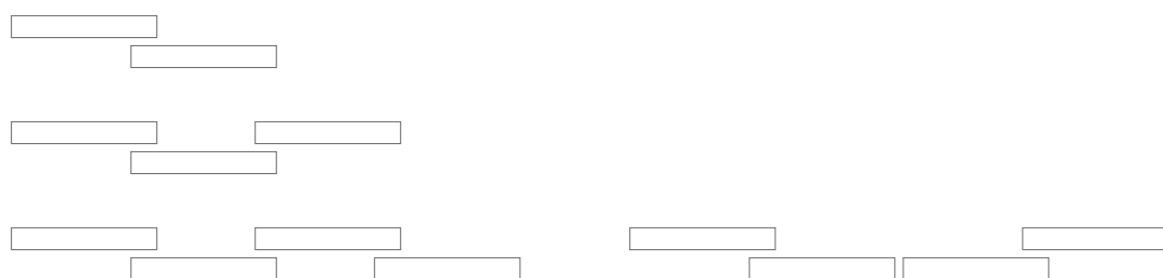

Tracks

	Max. door width	Length	Reference
Running track	As per setup	2000 mm	AF0.308.200
		3000 mm	AF0.308.300
		4000 mm	AF0.308.400
		6000 mm	AF0.308.600
Bottom guide track	As per setup	2000 mm	AF0.618.200
		3000 mm	AF0.618.300
		4000 mm	AF0.618.400
		6000 mm	AF0.618.600

Accessories selection

	Reference
Front panel	AF0.120
Rear panel	AF0.110
Softclose expansion	AF2.385.020*

Every fitting set comes with all the rollers, suspension, guiding systems and stoppers you need. One fitting set is required per door panel.
* With 1 softclose — min. door width = 345 mm, with 2 softcloses — min. door width = 525 mm

Technical drawings

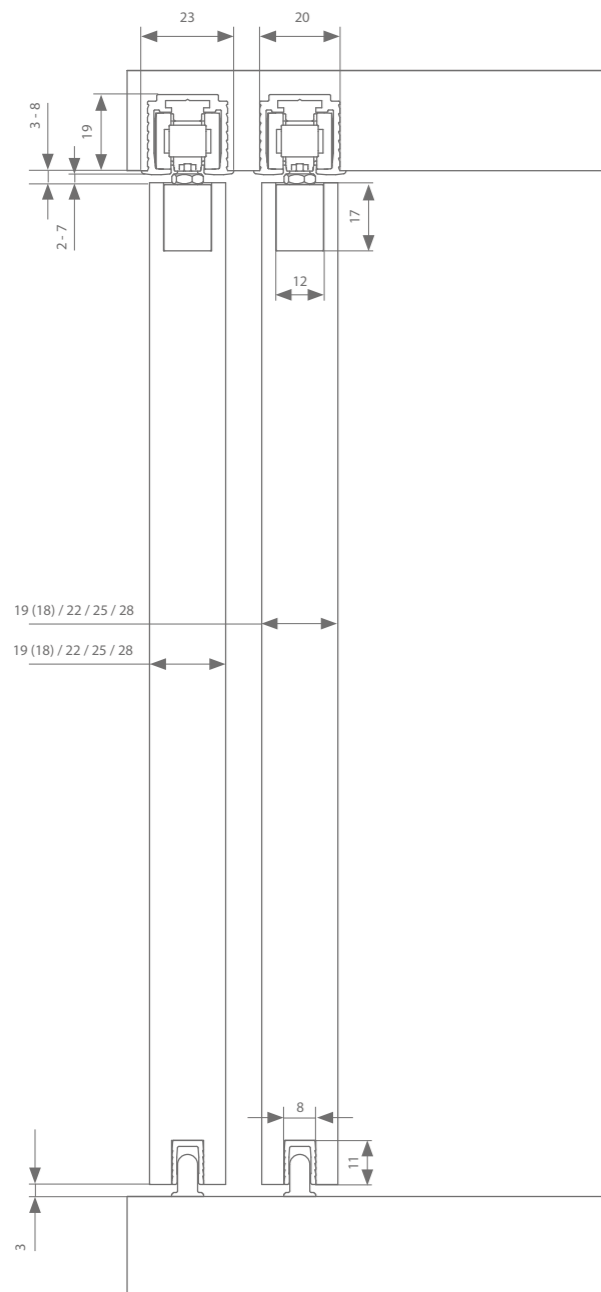

TIP



If two panels are used, the AF9.800.01 carrier carries the rear door.

possible configurations

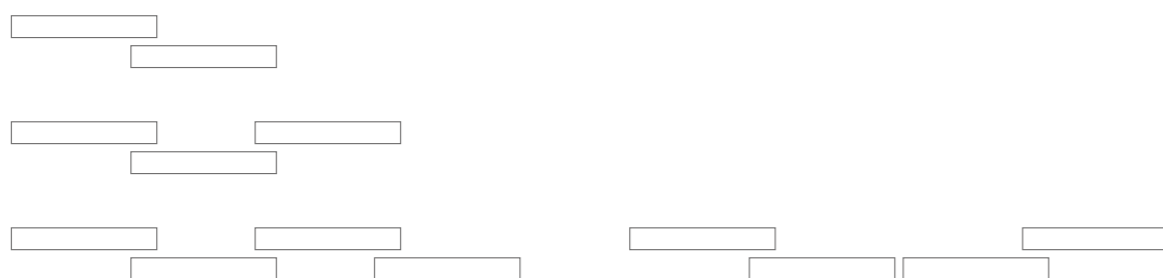

Tracks

	Max. door width	Length	Reference
Running track	As per setup	2000 mm	AF0.308.200
		3000 mm	AF0.308.300
		4000 mm	AF0.308.400
		6000 mm	AF0.308.600
Bottom guide track	1000 mm	1000 mm	AF0.608.100
	1250 mm	1250 mm	AF0.608.125
	1500 mm	1500 mm	AF0.608.150
	2000 mm	2000 mm	AF0.608.200
	3000 mm	3000 mm	AF0.608.300
	4000 mm	4000 mm	AF0.608.400

Accessories selection

	Reference
Fittings	AF0.800
Softclose expansion	AF2.385.020*

Every fitting set comes with all the rollers, suspension, guiding systems and stoppers you need. One fitting set is required per door panel.
* With 1 softclose — min. door width = 385 mm, with 2 softcloses — min. door width = 592 mm

Technical drawings

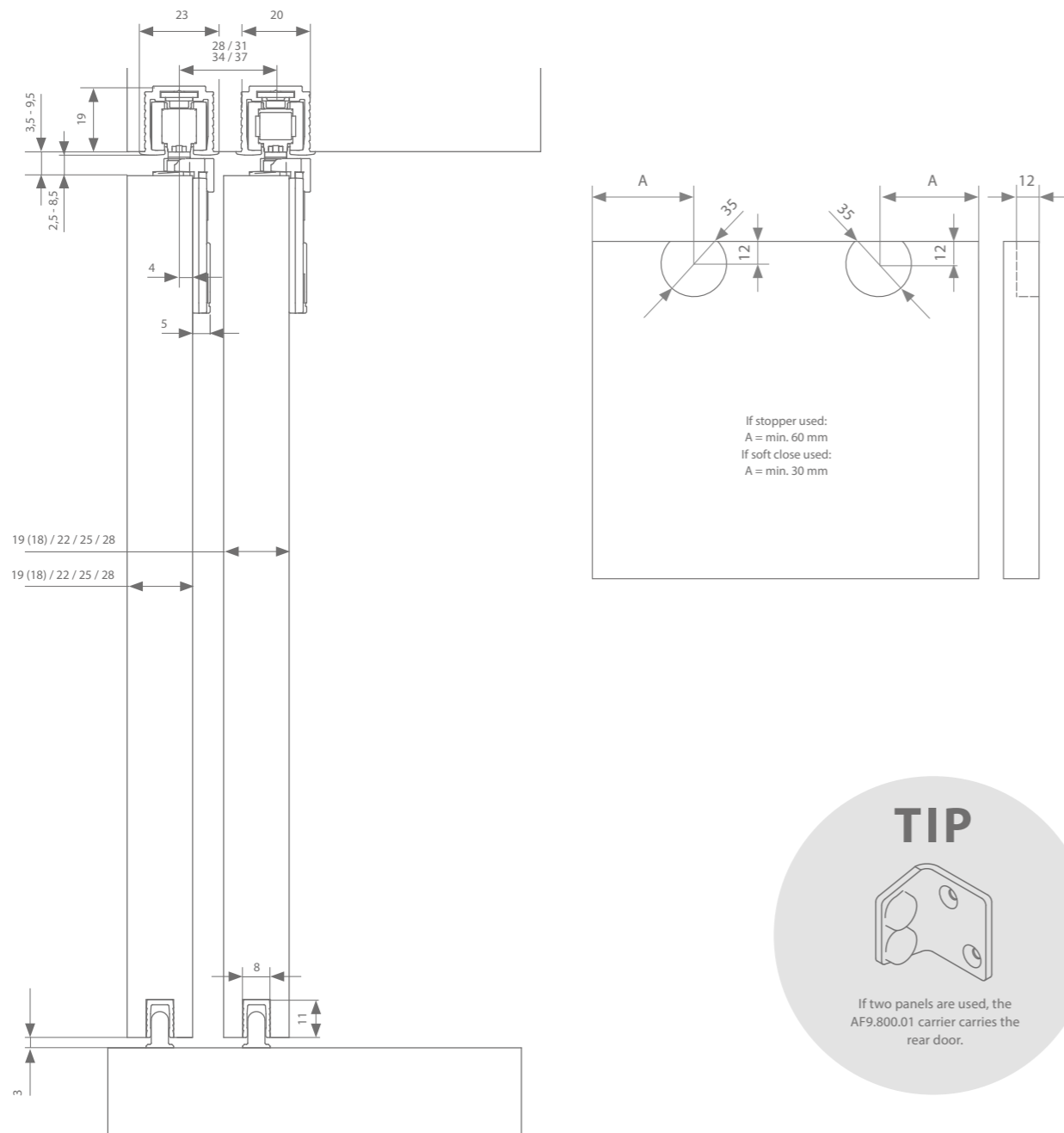

Tracks

	Max. door width	Length	Reference
Running track	As per setup	2000 mm	AF0.308.200
		3000 mm	AF0.308.300
		4000 mm	AF0.308.400
		6000 mm	AF0.308.600
Bottom guide track	1000 mm	1000 mm	AF0.608.100
	1250 mm	1250 mm	AF0.608.125
	1500 mm	1500 mm	AF0.608.150
	2000 mm	2000 mm	AF0.608.200
	3000 mm	3000 mm	AF0.608.300
	4000 mm	4000 mm	AF0.608.400

Accessories selection

	Reference
Fittings	AF0.100
Softclose expansion	AF2.385.020*

Every fitting set comes with all the rollers, suspension, guiding systems and stoppers you need. One fitting set is required per door panel.
 * With 1 softclose — min. door width = 345 mm, with 2 softcloses — min. door width = 525 mm

possible configurations





argenta
FORMAT

This series includes all accessories for the comfortable operation of forward-facing cabinet doors with a maximum weight of 50 kg per door. A height adjustment of 11 mm is possible, and the system can be used for panel thicknesses between 18 and 32 mm. Using a patented click system at the bottom, the cabinet doors can be single-handedly installed. The Format cabinet door hardware is our high-quality range, with attention being paid to design and sustainability. The hardware is hidden, making it seem like the doors are 'floating'.



anodised
aluminium

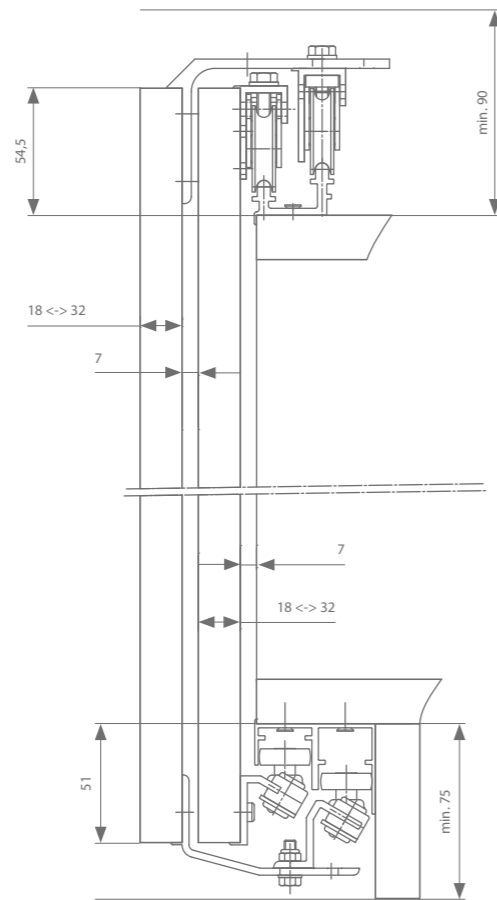
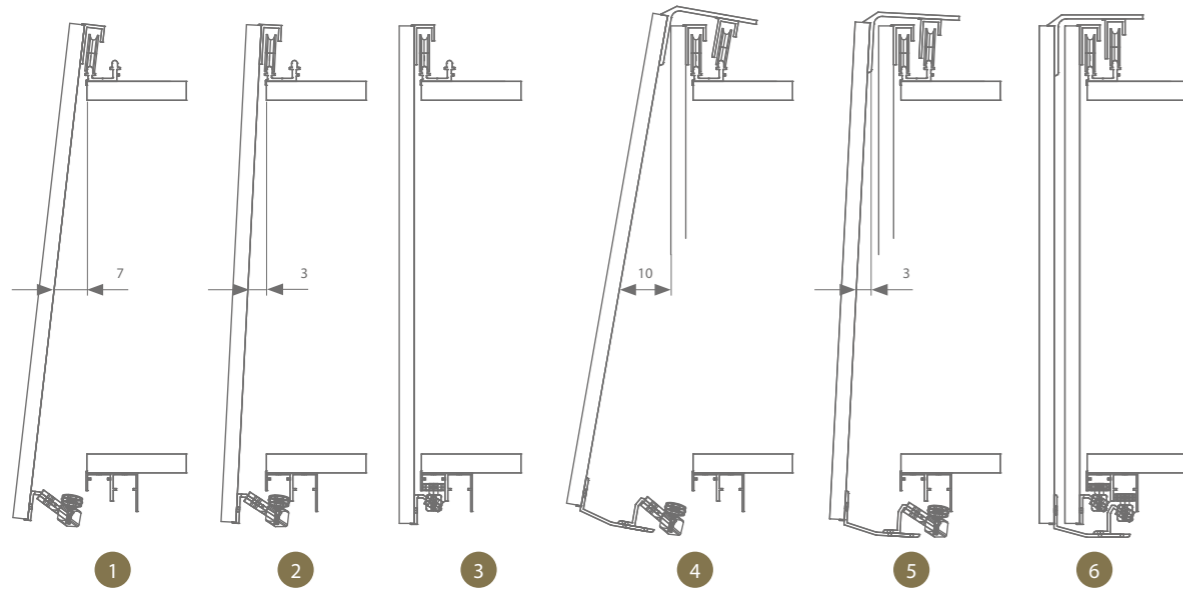

possible configurations

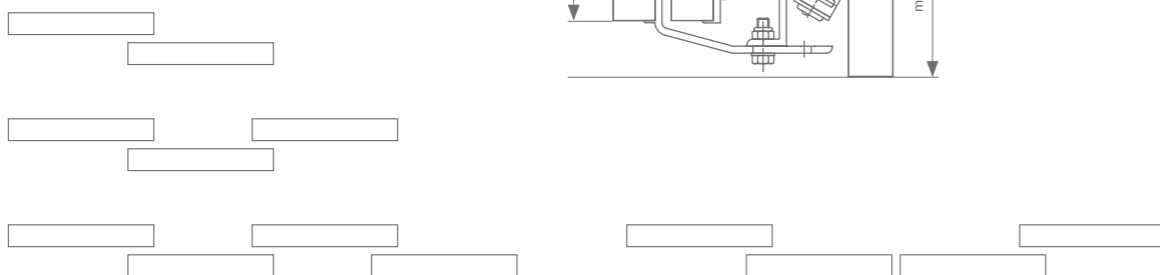

Tracks

	Max. door width	Length	Reference
Running track	As per setup	2000 mm	570.208.200
		3000 mm	570.208.300
		4000 mm	570.208.400
		6000 mm	570.208.600
Bottom guide track	2000 mm	2000 mm	570.608.200
	3000 mm	3000 mm	570.608.300
	4000 mm	4000 mm	570.608.400
	6000 mm	6000 mm	570.608.600

Accessories selection

	Reference
Front panel	574.600
Rear panel	574.100

Every fitting set comes with all the rollers, suspension, guiding systems and stoppers you need. One fitting set is required per door panel.



argenta
501.000

The easy-to-assemble cupboard door fitting of the 501.000 series provides smooth and quiet operation for panels with a maximum weight of 25 kg.

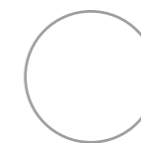

white

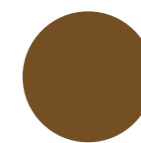

brown

X = MIN. 16 MM A = X + 6
 A = MIN. 22 MM B = X - 10
 B = MIN. 9 MM

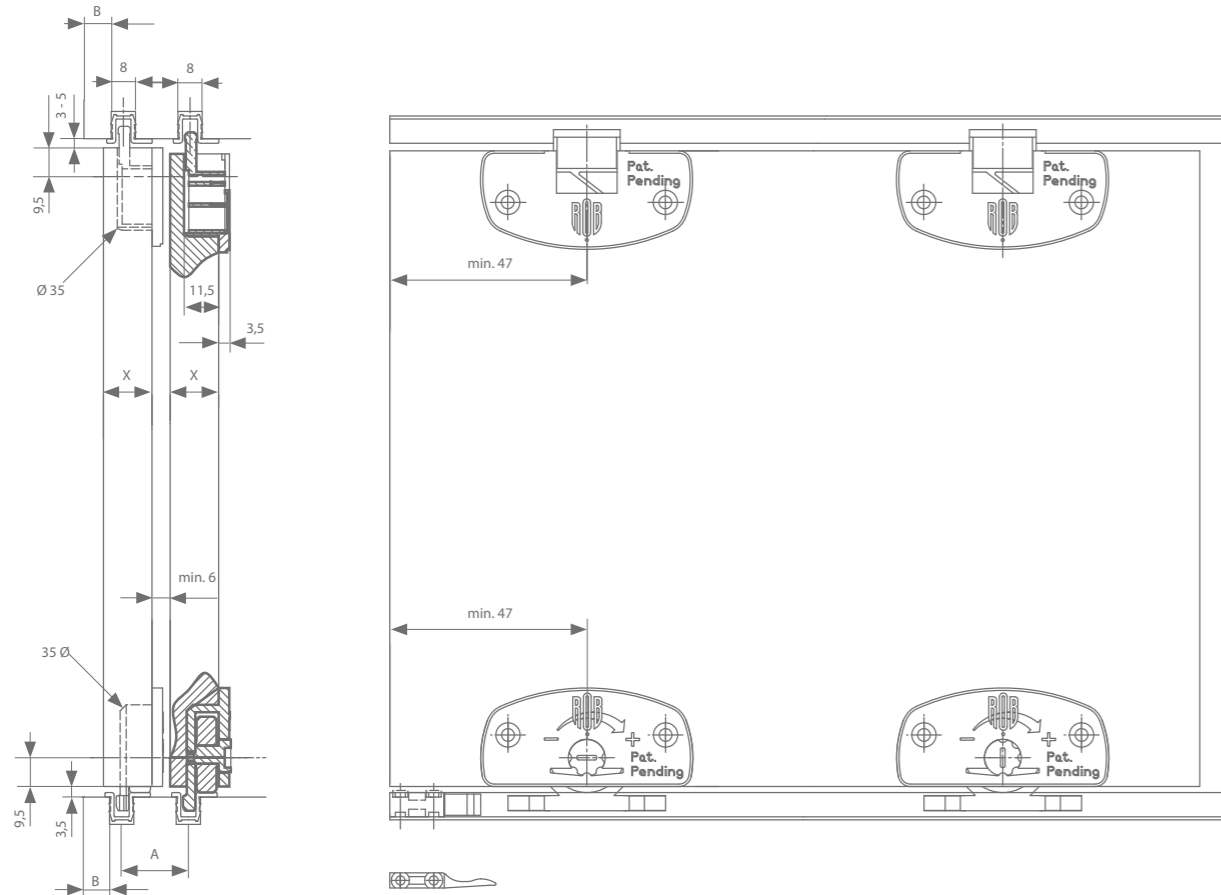

Tracks

	Max. door width	Length	Reference
Running track white	As per setup	3000 mm	501.001.300
		5000 mm	501.001.500
Running track brown	As per setup	3000 mm	501.003.300
		5000 mm	501.003.500

Accessories selection

	Reference
Gear white	501.101
Gear brown	501.103

All fitting sets come with the necessary rollers, guiding systems and stoppers. One fitting set is required per door panel.

possible configurations





argenta
SYMFO 60

Symfo 60 combines a top guiding system with bottom sliders to support doors up to a maximum weight of 60 kg . These fittings are suitable for panels between 16 and 19 mm thick. The rollers are attached at the back of the panel.



grey
anodised

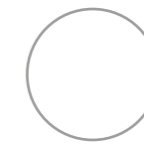

white
RAL 9003

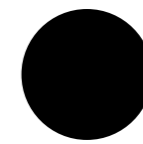

black
RAL 9005

Technical drawings

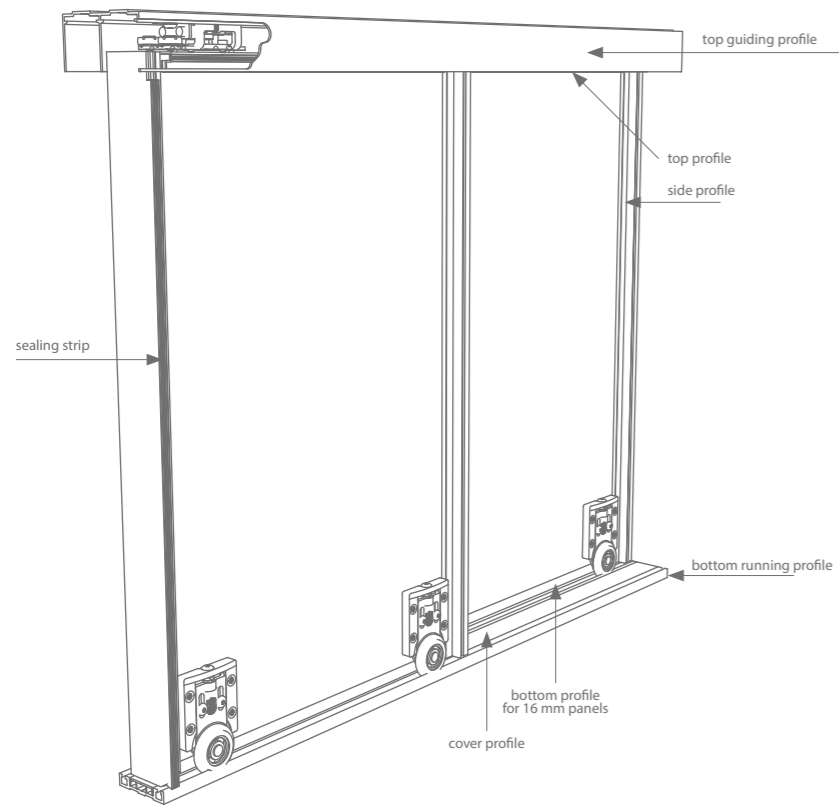

without upper roller guide

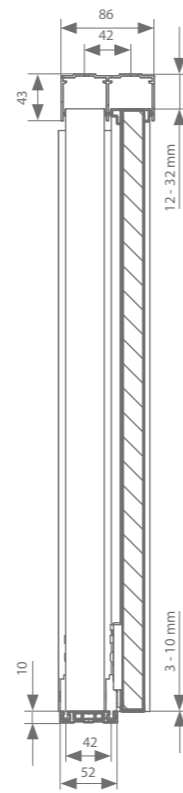

with upper roller guide

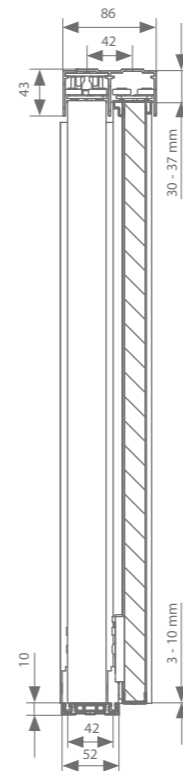
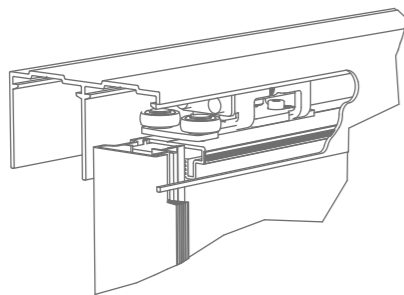

possible configurations

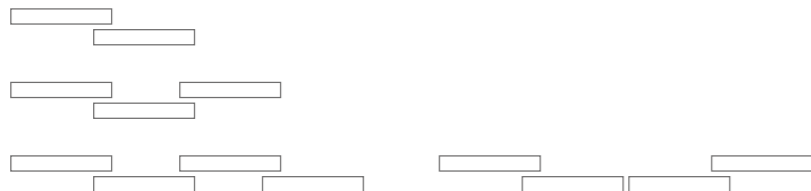

Tracks & profiles

	Max. door width	Length	Grey anodised	White	Black
Top guiding track	As per setup	2000 mm	DK0.118.200.0	DK0.118.200.1	DK0.118.200.2
		3000 mm	DK0.118.300.0	DK0.118.300.1	DK0.118.300.2
		6000 mm	DK0.118.600.0	DK0.118.600.1	DK0.118.600.2
Top guiding profile	2000 mm	2000 mm	DK0.418.200.0	DK0.418.200.1	DK0.418.200.2
	3000 mm	3000 mm	DK0.418.300.0	DK0.418.300.1	DK0.418.300.2
	6000 mm	6000 mm	DK0.418.600.0	DK0.418.600.1	DK0.418.600.2
Door handle profile	2600 mm	2600 mm	DK0.408.260.0	DK0.408.260.1	DK0.408.260.2
	5300 mm	5300 mm	DK0.408.530.0	DK0.408.530.1	DK0.408.530.2
Sealing strip		number of metres x	AM0.959.001	AM0.959.001	AM0.959.001
Adhesive conductive strip		1 m	DK0.419.001	DK0.419.001	DK0.419.001
Bottom profile for 16 mm panels	2000 mm	2000 mm	DK0.478.200.0	DK0.478.200.1	DK0.478.200.2
	3000 mm	3000 mm	DK0.478.300.0	DK0.478.300.1	DK0.478.300.2
	6000 mm	6000 mm	DK0.478.600.0	DK0.478.600.1	DK0.478.600.2
Bottom profile for 19 mm panels	2000 mm	2000 mm	DK0.428.200.0	DK0.428.200.1	DK0.428.200.2
	3000 mm	3000 mm	DK0.428.300.0	DK0.428.300.1	DK0.428.300.2
	6000 mm	6000 mm	DK0.428.600.0	DK0.428.600.1	DK0.428.600.2
Bottom running track	2000 mm	2000 mm	DK0.128.200.0	DK0.128.200.1	DK0.128.200.2
	3000 mm	3000 mm	DK0.128.300.0	DK0.128.300.1	DK0.128.300.2
	6000 mm	6000 mm	Dk0.128.600.0	Dk0.128.600.1	Dk0.128.600.2
Running track cover	2000 mm	2000 mm	DK0.908.200.0	DK0.908.200.1	DK0.908.200.2
	3000 mm	3000 mm	DK0.908.300.0	DK0.908.300.1	DK0.908.300.2
	6000 mm	6000 mm	DK0.908.600.0	DK0.908.600.1	DK0.908.600.2

Accessories selection

Fitting set for 1 door	Reference
Wheels	DK0.001
Upper roller guides and stoppers (side stoppers and pass-through stoppers)	DK0.101
Fitting set for 2 doors	
Wheels	DK0.002
Upper roller guides and stoppers (side stoppers and pass-through stoppers)	DK0.102
Fitting set for 3 doors	
Wheels	DK0.003
Upper roller guides and stoppers (side stoppers and pass-through stoppers)	DK0.103

The top profile is suitable for 19 mm panels; with adapters, it can also be used for 16 mm door panels. These adapters are always incorporated in the wheel fittings.



argenta symfo 60

Complete sets

	Bottom running & top guiding track	Grey anodised	White	Black
2 doors - Max. door width = 1000 mm - Max. door height = 2600 mm	2000 mm	DK0.152.0	DK0.152.1	DK0.152.2
2 doors - Max. door width = 1500 mm - Max. door height = 2600 mm	3000 mm	DK0.172.0	DK0.172.1	DK0.172.2
3 doors - Max. door width = 1000 mm - Max. door height = 2600 mm	3000 mm	DK0.173.0	DK0.173.1	DK0.173.2

A set includes all required parts for doors with an opening width of 2 or 3 metres, with panels that are up to 1 or 1.5 metres wide and up to 2600 mm tall. Aside from the fittings (type DK0.00X) and the top and bottom rails (with cover profiles), the frame profiles to affix the panels (16 mm/19 mm) are also supplied (with the bottom profile DK0.478. xxx), as are self-adhesive guiding strips. The stoppers and upper roller guides are not included in this set and must be ordered separately, e.g.: DK0.902 (upper roller guide for two doors) or DK0.903 (upper roller guide for three doors).



02

FURNITURE HARDWARE FOR GLASS PANELS

Bottom running sliding hardware. Panels can weigh up to 30 kg each, and an endless number of panels can be fitted next to each other.

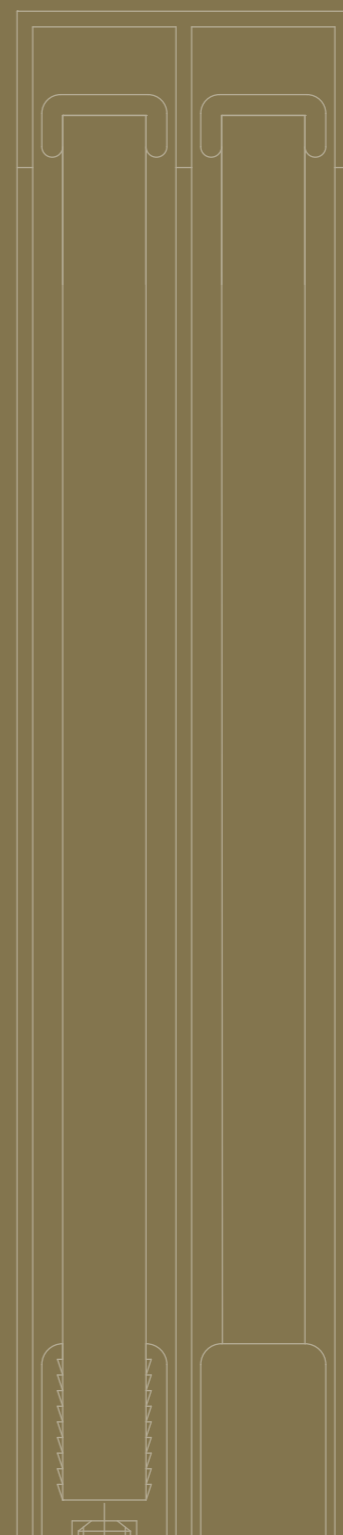



argenta
SLIDING GLASS

In this range, argenta® supplies excellent fitting sets for sliding glass windows. Such windows are suitable for many different purposes, such as display cabinets or counters. The range of sliding door hardware for glass windows that are supported from below is adjustable up to a maximum weight of 30 kg, with a maximum glass thickness of 8 mm.



grey
anodised

Technical drawing

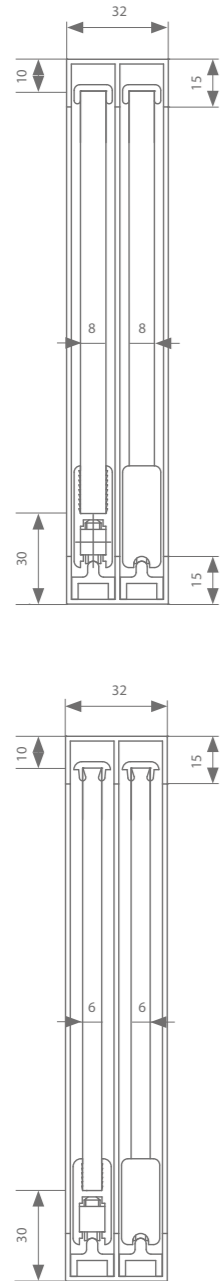

Tracks & profiles

	Max. door width	Length	Reference
Double U-top guide track	As per setup	750 mm	520.128.0
		1000 mm	520.138.0
		1500 mm	520.148.0
		2000 mm	520.158.0
		3000 mm	520.178.0
		6000 mm	520.198.0
Bottom running track	As per setup	750 mm	520.228.0
		1000 mm	520.238.0
		1500 mm	520.248.0
		2000 mm	520.258.0
		3000 mm	520.278.0
		6000 mm	520.298.0
8 mm glass profile	750 mm	750 mm	520.428.0
	1000 mm	1000 mm	520.438.0
	1500 mm	1500 mm	520.448.0
	2000 mm	2000 mm	520.458.0
	3000 mm	3000 mm	520.478.0
	6000 mm	6000 mm	520.498.0
6 mm glass profile	750 mm	750 mm	520.528.0
	1000 mm	1000 mm	520.538.0
	1500 mm	1500 mm	520.548.0
	2000 mm	2000 mm	520.558.0
	3000 mm	3000 mm	520.578.0
	6000 mm	6000 mm	520.598.0

Accessories selection

Fitting	Reference
8 mm	520.600.0
6 mm	520.700.0

Every fitting set comes with all the rollers, suspension, guiding systems and stoppers you need. One fitting set is required per door panel.

possible configurations

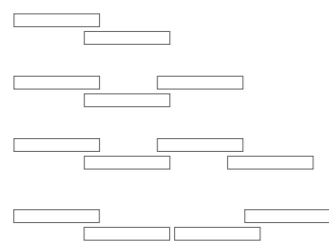

Choice of locks

Fitting	Direction	Reference
8 mm	Left	529.910
	Right	529.920
6 mm	Left	529.950
	Right	529.960

Technical drawing

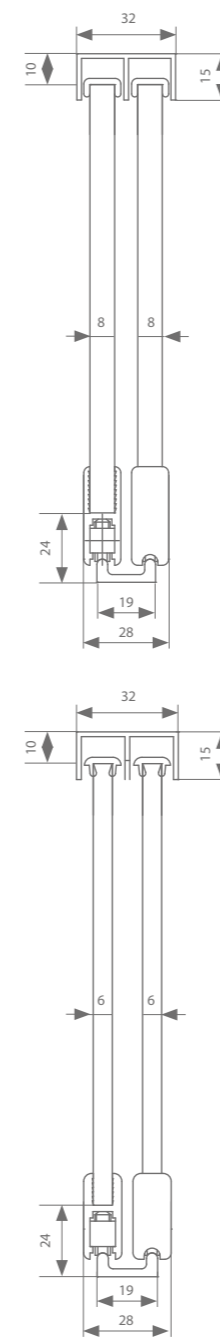

Tracks & profiles

	Max. door width	Length	Reference
Double U-top guide track	As per setup	750 mm	520.128.0
		1000 mm	520.138.0
		1500 mm	520.148.0
		2000 mm	520.158.0
		3000 mm	520.178.0
		6000 mm	520.198.0
Double bottom running track	As per setup	750 mm	520.328.0
		1000 mm	520.338.0
		1500 mm	520.348.0
		2000 mm	520.358.0
		3000 mm	520.378.0
		6000 mm	520.398.0
8 mm glass profile	750 mm	750 mm	520.428.0
	1000 mm	1000 mm	520.438.0
	1500 mm	1500 mm	520.448.0
	2000 mm	2000 mm	520.458.0
	3000 mm	3000 mm	520.478.0
	6000 mm	6000 mm	520.498.0
6 mm glass profile	750 mm	750 mm	520.528.0
	1000 mm	1000 mm	520.538.0
	1500 mm	1500 mm	520.548.0
	2000 mm	2000 mm	520.558.0
	3000 mm	3000 mm	520.578.0
	6000 mm	6000 mm	520.598.0

Accessories selection

Fitting	Reference
8 mm	520.600.0
6 mm	520.700.0

Every fitting set comes with all the rollers, suspension, guiding systems and stoppers you need. One fitting set is required per door panel.

possible configurations

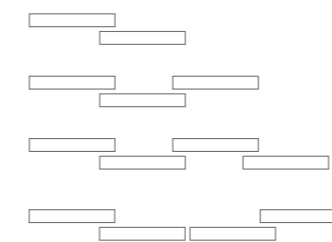

Choice of locks

Fitting	Direction	Reference
8 mm	Left	529.910
	Right	529.920
6 mm	Left	529.950
	Right	529.960

NOTES

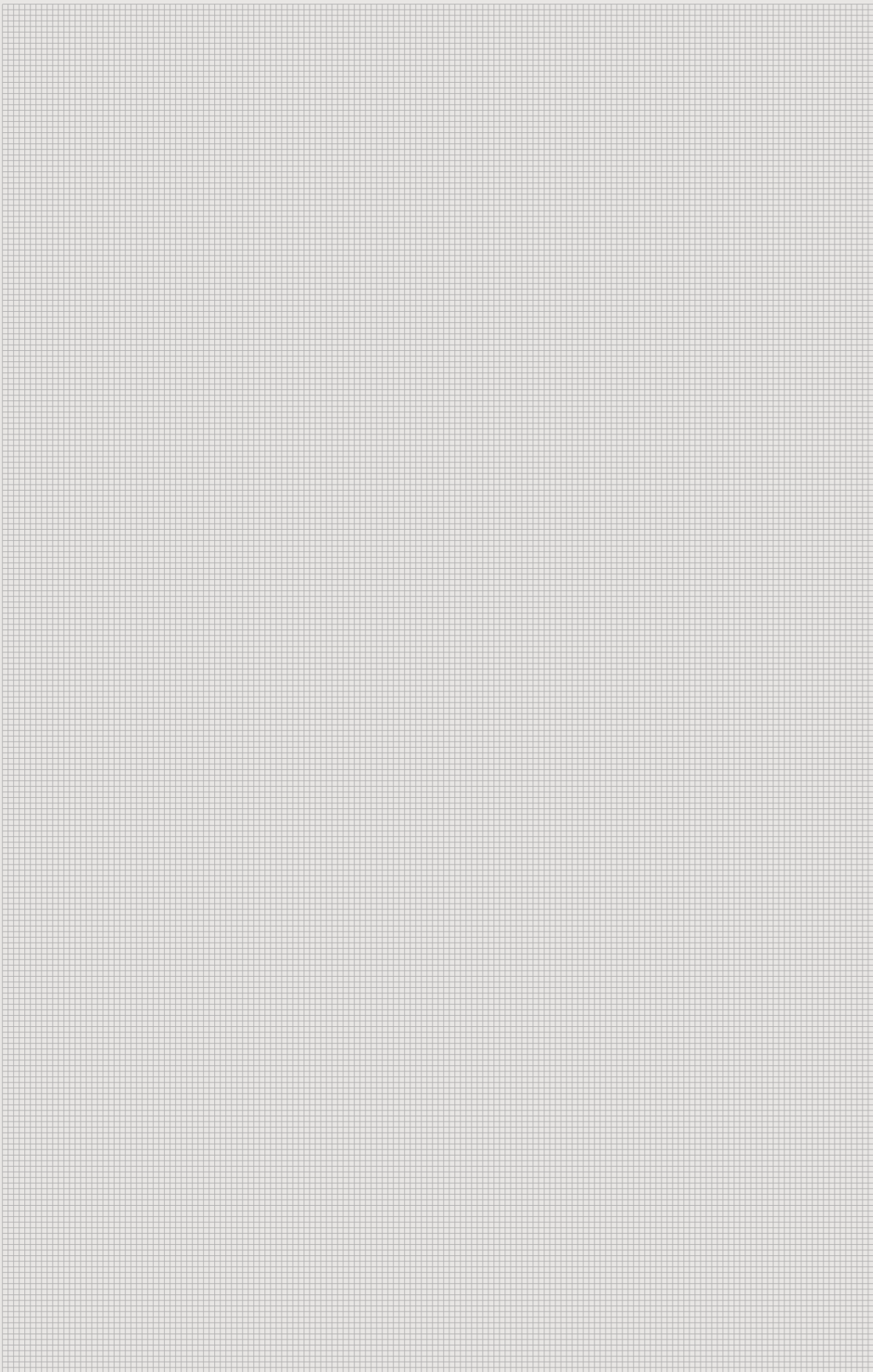



Ter Vlucht 2 +32 (0)51 27 05 00
8850 Ardoorie info@arlu.be
Belgium WWW.ARLU.BE



©L300042 04/24 English