



# XPERTA



 **argenta**

OPENING DOORS



## ARLU, THE REFERENCE FOR OPENING DOORS

ARLU® is the manufacturer behind the brand names argenta® and rob®. Argenta has been a leading brand in door hardware for over 100 years, but today it is mainly synonymous with invisible door systems.

Minimalist architecture swears by clean lines and a “back to the essence” mentality. In terms of interior doors, this results in integrated door fittings, invisible integrated techniques, door frames and skirting boards for swing, sliding and pivoting doors

Argenta stands for a full range of sleek interior solutions.

ALL TECHNICAL DRAWINGS ARE SHOWN IN MILLIMETRES AND ARE SUBJECT TO CHANGE BY ARLU.

# 01 WOOD

- 6** SINGLE DOOR
- 8** ceiling mount
- 12** compact ceiling mount
- 14** wall mount without skirting
- 18** wall mount without skirting with brackets
- 22** compact wall mount without skirting
- 24** wall mount with skirting
- 26** wall mount with skirting and brackets
- 28** compact wall mount with skirting
- 30** autoclose
- 32** FLUSH INTO CEILING
- 36** SYMMETRIC
- 38** ceiling mount
- 42** wall mount without skirting
- 46** wall mount without skirting with brackets
- 50** wall mount with skirting
- 52** wall mount with skirting and brackets
- 54** TELESCOPIC
- 56** dual telescopic ceiling mount
- 58** dual parallel ceiling mount
- 60** compact dual parallel ceiling mount
- 62** triple telescopic ceiling mount
- 64** triple parallel ceiling mount
- 66** compact triple parallel ceiling mount
- 68** MOTORISATION

# 02 GLASS

- 72** SINGLE DOOR
- 74** ceiling mount
- 76** wall mount
- 78** FLUSH INTO CEILING

# 01

## XPERTA WOOD

ARLU® is a specialist in sliding door systems, known for its expert and proslide ranges. As pioneers, we have a strong focus on development and continuous improvement. With Xperta, ARLU is taking the next step in its mission to make a difference in many interiors. The products and solutions evolve in line with the challenging international hardware market, offering many benefits for architects, carpenters and interior fitters. The unique double action softclose, silent wheels and compact suspension are just a few of the advantages of the new range.

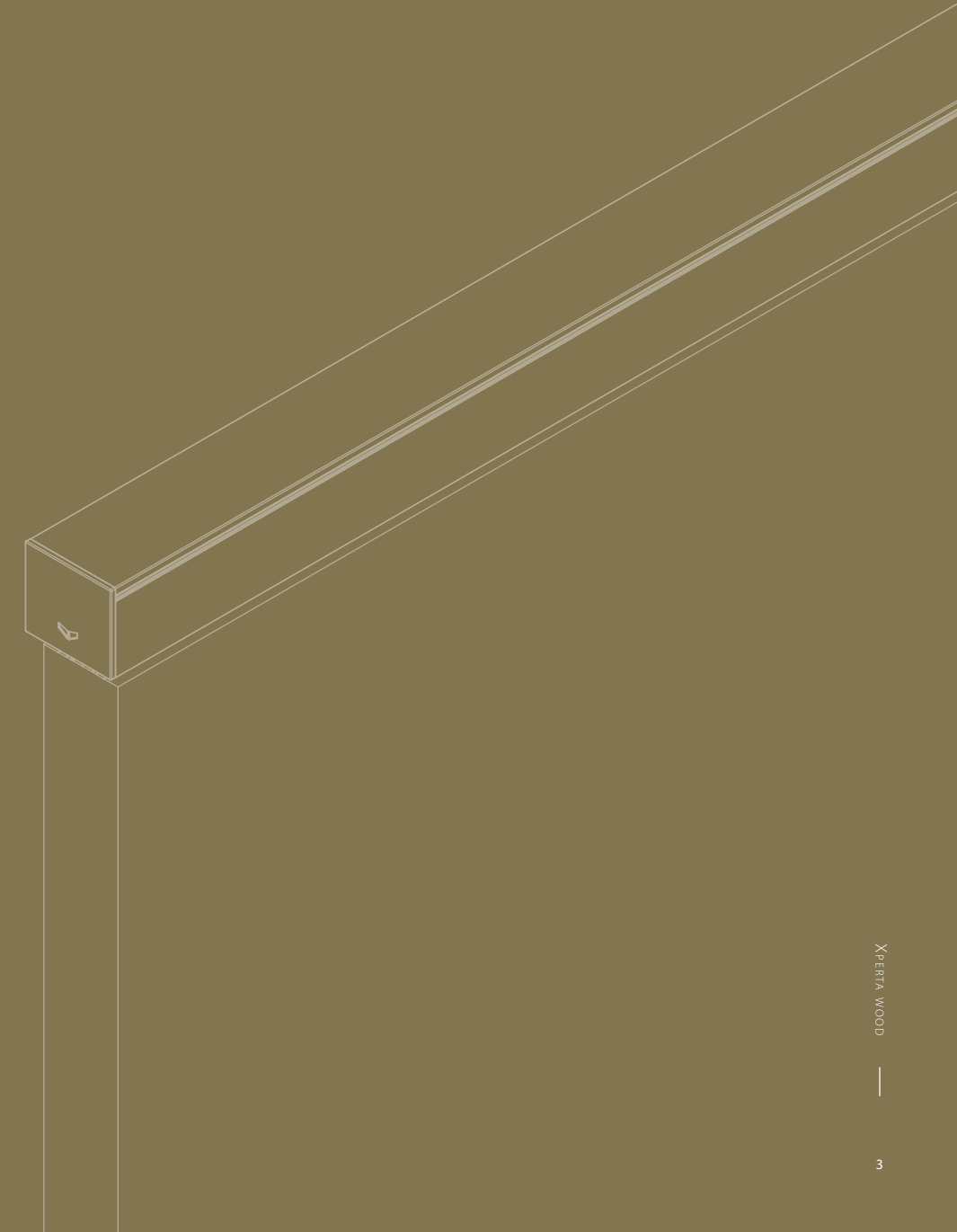

argenta Xperta wood  
why choose Xperta?

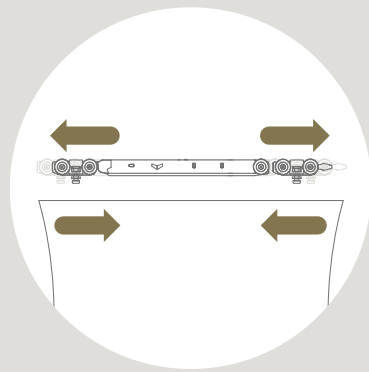

**DOUBLE-ACTION  
SOFTCLOSE**

for gentle opening and closing of doors. The compact design makes it suitable for extremely narrow doors.

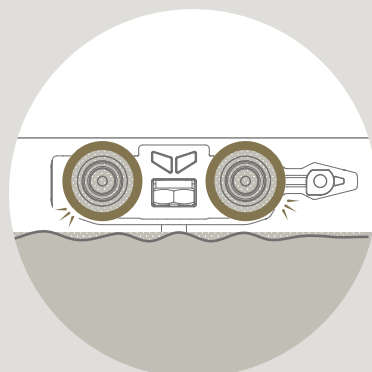

**MINIMUM ROLLING  
RESISTANCE,  
MAXIMUM NOISE  
REDUCTION**

thanks to wheels with a hard running surface and soft core.

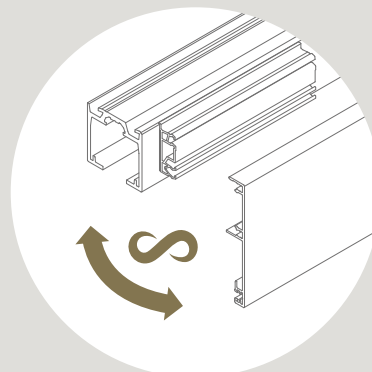

**UNIVERSAL COVER  
PROFILE AND  
RUNNING TRACK**

for every installation. Quick assembly thanks to unique mounting clips.

Choice of narrow or wide wall profile

Quick (dis)assembly thanks to the ESSI® module

Separate activator channel

**TIP**



You can use connection piece AAA.11011000.00 to connect two profiles in line.

Easy clip-in system

**TIP**



The AAA.25100000.07 guide is ideal in situations where you prefer not to fix the guiding channel to the floor.

0.16"

**ONLY 0.16" CLEARANCE**  
between door and running track when using auto-fix or manual-fix.

Xperta is a universal solution for wooden doors up to 220 lbs. The unique running track and silent rollers ensure optimal movement of every sliding door. Xperta can be mounted with matching wall and cover profiles, or with the running track directly under the ceiling.

The Xperta invisible running track allows for an even sleeker finish in a suspended ceiling.

Bottom guiding track

Available in three colours  
F1 anodised aluminium, black  
and white textured coating







## Xperta 220 lbs **SINGLE DOOR**

Xperta sliding doors stand out for their quiet operation, versatility, intuitive installation, sleek design and durability. The unique double-action softclose ensures a comfortable use of the sliding door. The compact suspension with auto-fix, combined with the slim running and wall profiles, guarantee a quick installation with a minimalistic result.

PROFILE LENGTH

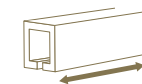

78.7 | 118.1 |  
157.5 | 236.2"

INSTALLATION



DOOR WEIGHT



MAX.  
**220**  
LBS



anodised aluminium

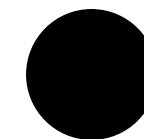

black textured coating  
RAL 9005



white textured coating  
RAL 9016

Technical drawings

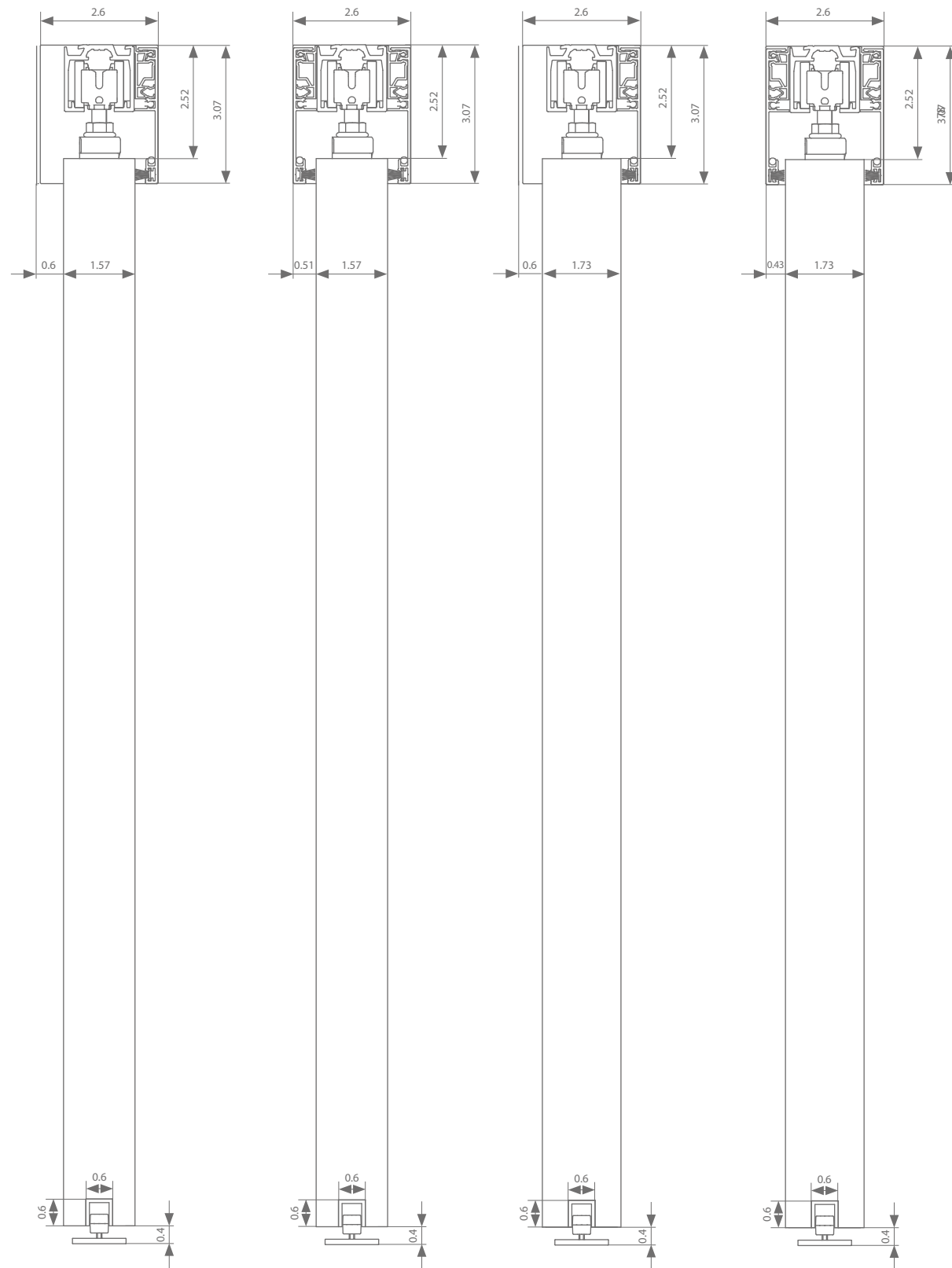

Ceiling mount 1.57"

Ceiling mount 1.73"



Height adjustment: + - 0.16"

Profiles

	Max. door width	Length			
<b>Running track</b>	39.4"	78.7"	AAA.11000200.02	AAA.11000200.07	AAA.11000200.05
	59"	118.1"	AAA.11000300.02	AAA.11000300.07	AAA.11000300.05
	78.7"	157.5"	AAA.11000400.02	AAA.11000400.07	AAA.11000400.05
	118.1"	236.2"	AAA.11000600.02	AAA.11000600.07	AAA.11000600.05
<b>ESSI®-module (optional)</b>		3.94"	AAA.11010010.02	AAA.11010010.07	AAA.11010010.05
<b>Cover profile</b>	39.4"	78.7"	AAA.12000200.02	AAA.12000200.07	AAA.12000200.05
	59"	118.1"	AAA.12000300.02	AAA.12000300.07	AAA.12000300.05
	78.7"	157.5"	AAA.12000400.02	AAA.12000400.07	AAA.12000400.05
	118.1"	236.2"	AAA.12000600.02	AAA.12000600.07	AAA.12000600.05
<b>+ narrow clips</b> 1 per metre of cover profile		3.94"		AAA.12010010.07	
<b>Set of end caps</b>			AAA.92020000.02	AAA.92020000.07	AAA.92020000.05
<b>Seal</b>	39.4"	78.7"	AAA.12010200.02	AAA.12010200.07	
	59"	118.1"	AAA.12010300.02	AAA.12010300.07	
	78.7"	157.5"	AAA.12010400.02	AAA.12010400.07	
	118.1"	236.2"	AAA.12010600.02	AAA.12010600.07	
<b>Bottom guiding track</b>	39.4"	39.4"	AAA.15000100.00		
	49.2"	49.2"	AAA.15000125.00		
	59"	59"	AAA.15000150.00		
	78.7"	78.7"	AAA.15000200.00		
	118.1"	118.1"	AAA.15000300.00		
	236.2"	236.2"	AAA.15000600.00		

Fittings selection

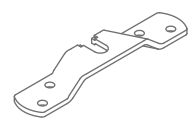

Transverse suspension	Min. door width	Min. door width ESSI	Reference
With 2 stoppers	13.9"	17.2"	AAA.20000000.00
With double-action softclose	22.8"	26.1"	AAA.20020000.00

Motorised set\*

Transverse suspension with motor	Min. door width	Min. door width ESSI	Length	Reference
Fittings	A-slide**	27.6"	31.3"	AAA.20030000.00
Belt	Min. belt length = (4 x door width) + 7.9"		1968.5"	AK9.709.050
			787.4"	AK9.709.020
			393.7"	AK9.709.010
Remote control	for 1 channel			AM3.100.104.61
	for 4 channels			AM3.100.104.252

\* see p.68 for more information

\*\* For matching end caps and clips, see p.11.

Every fitting set comes with all the rollers or softclose mechanisms, suspension, guiding systems and stoppers you need.

Technical drawings

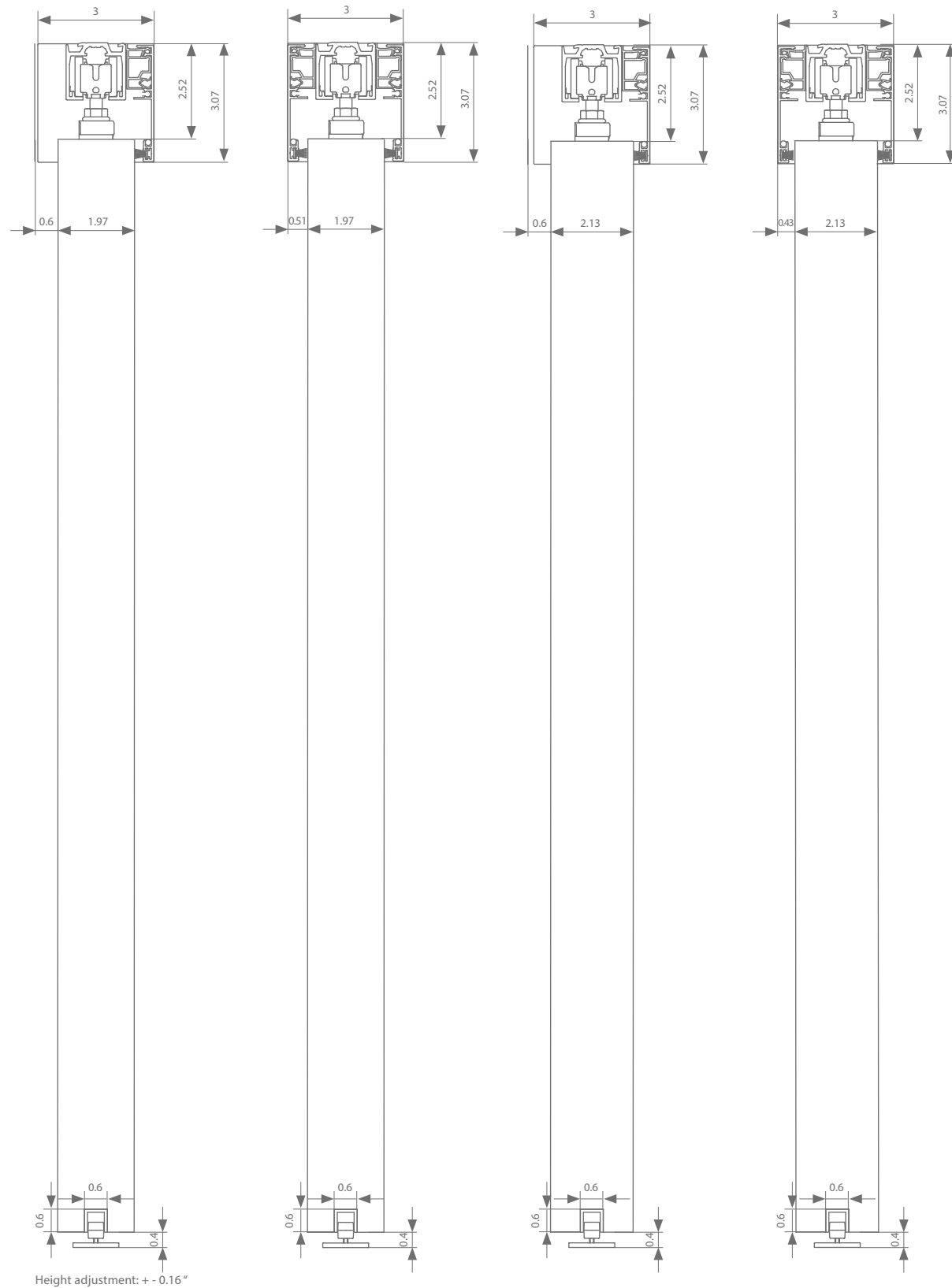

Ceiling mount 1.97"

Ceiling mount 2.13"



Height adjustment: + - 0.16"

Profiles

	Max. door width	Length				
<b>Running track</b>	39.4"	78.7"	AAA.11000200.02	AAA.11000200.07	AAA.11000200.05	
	59"	118.1"	AAA.11000300.02	AAA.11000300.07	AAA.11000300.05	
	78.7"	157.5"	AAA.11000400.02	AAA.11000400.07	AAA.11000400.05	
	118.1"	236.2"	AAA.11000600.02	AAA.11000600.07	AAA.11000600.05	
<b>ESSI®-module (optional)</b>		3.94"	AAA.11010010.02	AAA.11010010.07	AAA.11010010.05	
	<b>Cover profile</b>	39.4"	78.7"	AAA.12000200.02	AAA.12000200.07	AAA.12000200.05
		59"	118.1"	AAA.12000300.02	AAA.12000300.07	AAA.12000300.05
78.7"		157.5"	AAA.12000400.02	AAA.12000400.07	AAA.12000400.05	
118.1"		236.2"	AAA.12000600.02	AAA.12000600.07	AAA.12000600.05	
<b>+ wide clips 1 per metre of cover profile</b>		3.94"		AAA.12020010.07		
		39.4"		AAA.12020100.07		
<b>Set of end caps</b>			AAA.92040000.02	AAA.92040000.07	AAA.92040000.05	
	<b>Seal</b>	39.4"	78.7"	AAA.12010200.02	AAA.12010200.07	
		59"	118.1"	AAA.12010300.02	AAA.12010300.07	
78.7"		157.5"	AAA.12010400.02	AAA.12010400.07		
118.1"		236.2"	AAA.12010600.02	AAA.12010600.07		
<b>Bottom guiding track</b>	39.4"	39.4"	AAA.15000100.00			
	49.2"	49.2"	AAA.15000125.00			
	59"	59"	AAA.15000150.00			
	78.7"	78.7"	AAA.15000200.00			
	118.1"	118.1"	AAA.15000300.00			
	236.2"	236.2"	AAA.15000600.00			

Fittings selection

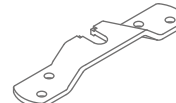
	Transverse suspension	Min. door width	Min. door width ESSI	Reference
	With 2 stoppers	13.9"	17.2"	AAA.20000000.00
	With double-action softclose	22.8"	26.1"	AAA.20020000.00

Motorised set\*

	Transverse suspension with motor	Min. door width	Min. door width ESSI	Length	Reference
Fittings	A-slide	27.6"	31.3"		AAA.20030000.00
Belt	Min. belt length = (4 x door width) + 7.9"			1968.5"	AK9.709.050
				787.4"	AK9.709.020
				393.7"	AK9.709.010
Remote control	for 1 channel				AM3.100.104.61
	for 4 channels				AM3.100.104.252



\* see p.68 for more information

Every fitting set comes with all the rollers or softclose mechanisms, suspension, guiding systems and stoppers you need.

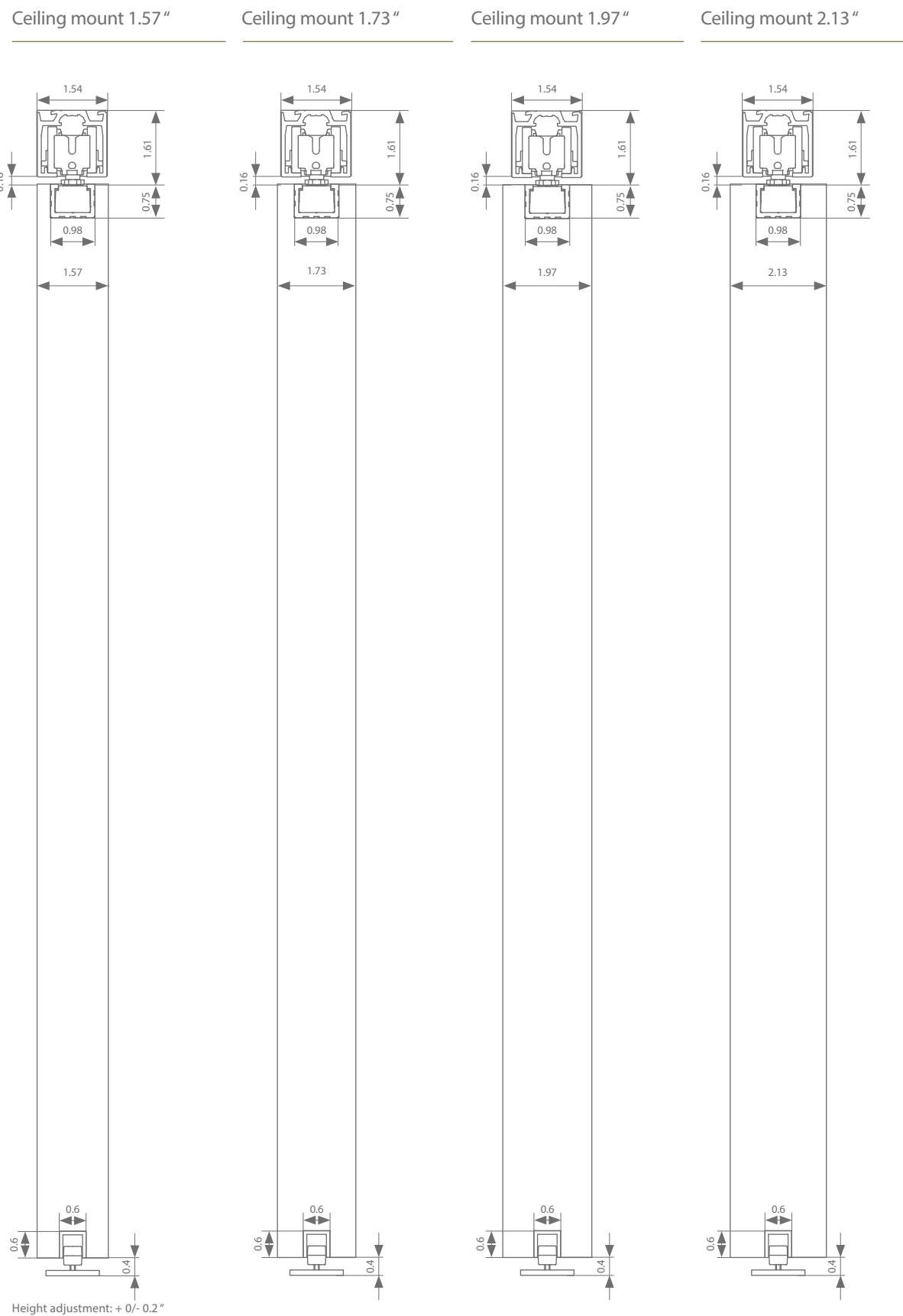
Technical drawings



Profiles

	Max. door width	Length			
<b>Running track</b>	39.4"	78.7"	AAA.11000200.02	AAA.11000200.07	AAA.11000200.05
	59"	118.1"	AAA.11000300.02	AAA.11000300.07	AAA.11000300.05
	78.7"	157.5"	AAA.11000400.02	AAA.11000400.07	AAA.11000400.05
	118.1"	236.2"	AAA.11000600.02	AAA.11000600.07	AAA.11000600.05
<b>ESSI®-module (optional)</b>		3.94"	AAA.11010010.02	AAA.11010010.07	AAA.11010010.05
<b>Set of end caps</b>			AAA.91000000.02	AAA.91000000.07	AAA.91000000.05
<b>Suspension profile (optional)</b>		9.8**	AAA.14000025.00 (2 x)		
	39.4"	39.4"	AAA.14000100.00		
	49.2"	49.2"	AAA.14000125.00		
	59"	59"	AAA.14000150.00		
	78.7"	78.7"	AAA.14000200.00		
	118.1"	118.1"	AAA.14000300.00		
	236.2"	236.2"	AAA.14000600.00		
<b>End cap suspension profile (optional)</b>			AAA.94000000.02	AAA.94000000.07	AAA.94000000.05
<b>Bottom guiding track</b>	39.4"	39.4"	AAA.15000100.00		
	49.2"	49.2"	AAA.15000125.00		
	59"	59"	AAA.15000150.00		
	78.7"	78.7"	AAA.15000200.00		
	118.1"	118.1"	AAA.15000300.00		
	236.2"	236.2"	AAA.15000600.00		

\* cannot be combined with ESSI®

Fittings selection

	Compact suspension	Min. door width	Min. door width ESSI	Reference
	With 2 stoppers	14.1"	17.4"	AAA.20100000.00
	Double-action softclose	23.2"	26.1"	AAA.20120000.00
	With 2 stoppers	14.1"	17.4"	AAA.20200000.00
	Double-action softclose	23.2"	26.1"	AAA.20220000.00

Every fitting set comes with all the rollers or softclose mechanisms, suspension, guiding systems and stoppers you need.

argenta Xperta wood  
wall mount 1.57/1.73 " without skirting

Technical drawings

Wall mount 1.57"

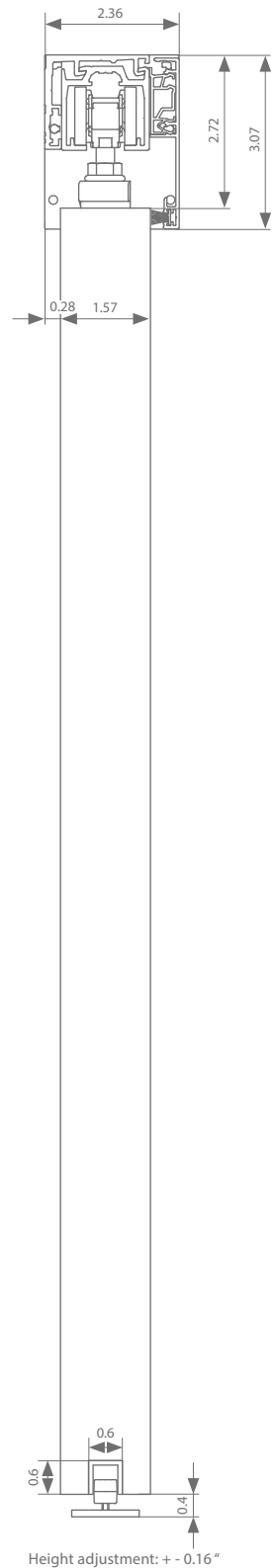

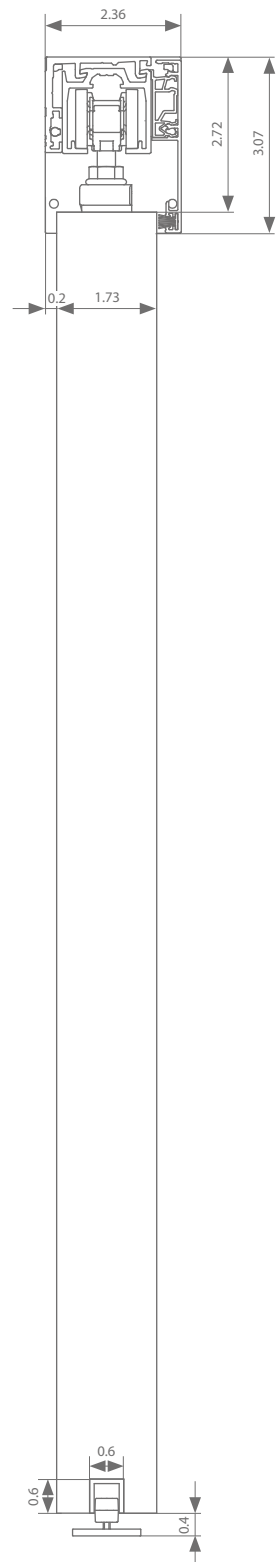

Wall mount 1.73"



Profiles

assemble your set 

	Max. door width	Length			
<b>Running track</b>	39.4"	78.7"	AAA.11000200.02	AAA.11000200.07	AAA.11000200.05
	59"	118.1"	AAA.11000300.02	AAA.11000300.07	AAA.11000300.05
	78.7"	157.5"	AAA.11000400.02	AAA.11000400.07	AAA.11000400.05
	118.1"	236.2"	AAA.11000600.02	AAA.11000600.07	AAA.11000600.05
<b>ESSI®-module (optional)</b>		3.94"	AAA.11010010.02	AAA.11010010.07	AAA.11010010.05
<b>Wall profile</b>	39.4"	78.7"	AAA.13000200.02	AAA.13000200.07	AAA.13000200.05
	59"	118.1"	AAA.13000300.02	AAA.13000300.07	AAA.13000300.05
	78.7"	157.5"	AAA.13000400.02	AAA.13000400.07	AAA.13000400.05
	118.1"	236.2"	AAA.13000600.02	AAA.13000600.07	AAA.13000600.05
<b>+ mounting set</b>		1 per 118.1"	AAA.13010000.07		
<b>Cover profile</b>	39.4"	78.7"	AAA.12000200.02	AAA.12000200.07	AAA.12000200.05
	59"	118.1"	AAA.12000300.02	AAA.12000300.07	AAA.12000300.05
	78.7"	157.5"	AAA.12000400.02	AAA.12000400.07	AAA.12000400.05
	118.1"	236.2"	AAA.12000600.02	AAA.12000600.07	AAA.12000600.05
<b>+ narrow clips</b> 1 per metre of cover profile		3.94"	AAA.12010010.07		
<b>Set of end caps</b>			AAA.92000000.02	AAA.92000000.07	AAA.92000000.05
<b>Seal</b>	39.4"	78.7"	AAA.12010200.02	AAA.12010200.07	
	59"	118.1"	AAA.12010300.02	AAA.12010300.07	
	78.7"	157.5"	AAA.12010400.02	AAA.12010400.07	
	118.1"	236.2"	AAA.12010600.02	AAA.12010600.07	
<b>Bottom guiding track</b>	39.4"	39.4"	AAA.15000100.00		
	49.2"	49.2"	AAA.15000125.00		
	59"	59"	AAA.15000150.00		
	78.7"	78.7"	AAA.15000200.00		
	118.1"	118.1"	AAA.15000300.00		
	236.2"	236.2"	AAA.15000600.00		

Fittings selection



	Transverse suspension	Min. door width	Min. door width ESSI	Reference
	With 2 stoppers	13.9"	17.2"	AAA.20000000.00
	With double-action softclose	22.8"	26.1"	AAA.20020000.00

Motorised set\*

Transverse suspension with motor	Min. door width	Min. door width ESSI	Length	Reference
Fittings	A-slide**	27.6"	31.3"	AAA.20030000.00
Belt	Min. belt length = (4 x door width) + 7.9"		1968.5"	AK9.709.050
			787.4"	AK9.709.020
			393.7"	AK9.709.010
Remote control	for 1 channel			AM3.100.104.61
	for 4 channels			AM3.100.104.2.52

Every fitting set comes with all the rollers or softclose mechanisms, suspension, guiding systems and stoppers you need.

Complete sets

	Max. door width	Length			
<b>With 2 stoppers</b>	39.4"	78.7"	AAA.32000200.02	AAA.32000200.07	AAA.32000200.05
<b>Double-action softclose</b>	39.4"	78.7"	AAA.32002200.02	AAA.32002200.07	AAA.32002200.05

\* see p.68 for more information  
\*\* Cannot be combined with cover profiles and end caps



argenta Xperta wood  
wall mount 1.97/2.13 " without skirting

Technical drawings

Wall mount 1.97"

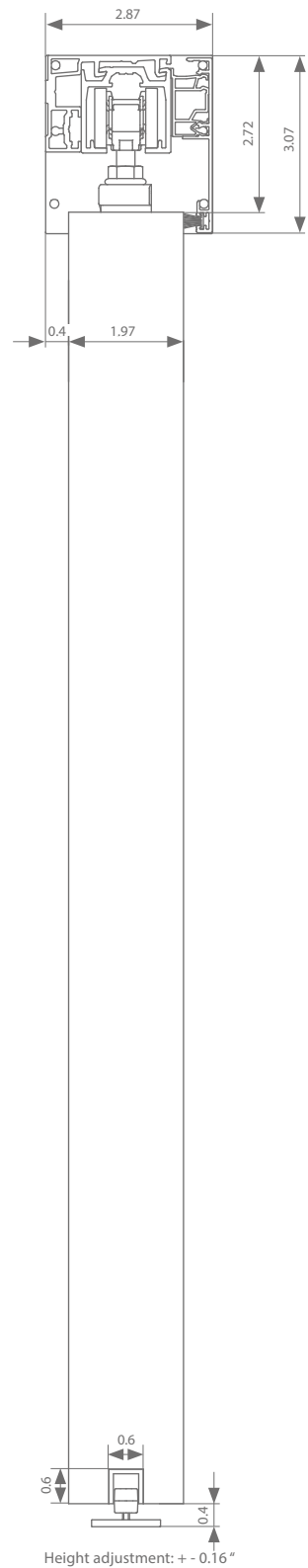

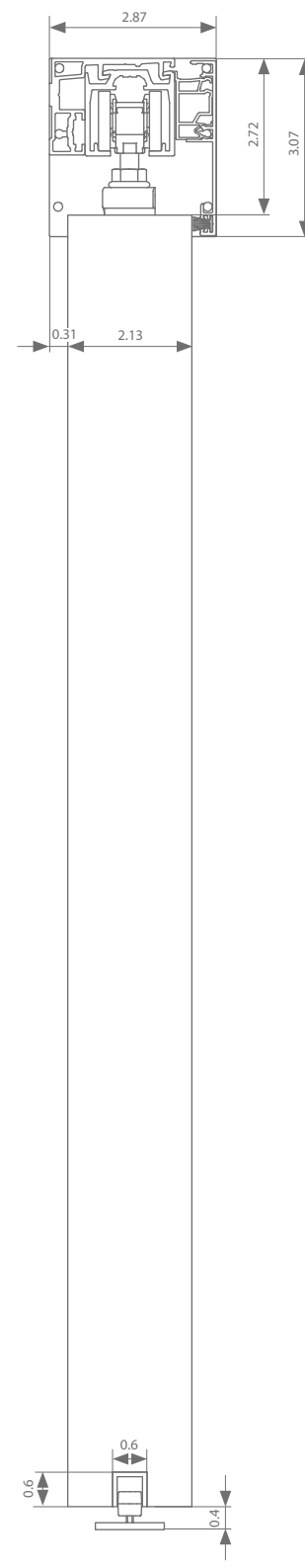

Wall mount 2.13"



Profiles

assemble your set 

	Max. door width	Length			
<b>Running track</b>	39.4"	78.7"	AAA.11000200.02	AAA.11000200.07	AAA.11000200.05
	59"	118.1"	AAA.11000300.02	AAA.11000300.07	AAA.11000300.05
	78.7"	157.5"	AAA.11000400.02	AAA.11000400.07	AAA.11000400.05
	118.1"	236.2"	AAA.11000600.02	AAA.11000600.07	AAA.11000600.05
<b>ESSI®-module (optional)</b>		3.94"	AAA.11010010.02	AAA.11010010.07	AAA.11010010.05
<b>Wall profile</b>	39.4"	78.7"	AAA.13100200.02	AAA.13100200.07	AAA.13100200.05
	59"	118.1"	AAA.13100300.02	AAA.13100300.07	AAA.13100300.05
	78.7"	157.5"	AAA.13100400.02	AAA.13100400.07	AAA.13100400.05
	118.1"	236.2"	AAA.13100600.02	AAA.13100600.07	AAA.13100600.05
<b>+ mounting set</b>		1 per 118.1"		AAA.13010000.07	
<b>Cover profile</b>	39.4"	78.7"	AAA.12000200.02	AAA.12000200.07	AAA.12000200.05
	59"	118.1"	AAA.12000300.02	AAA.12000300.07	AAA.12000300.05
	78.7"	157.5"	AAA.12000400.02	AAA.12000400.07	AAA.12000400.05
	118.1"	236.2"	AAA.12000600.02	AAA.12000600.07	AAA.12000600.05
<b>+ wide clips</b> 1 per metre of cover profile		3.94"		AAA.12020010.07	AAA.12020100.07
<b>Set of end caps</b>			AAA.92030000.02	AAA.92030000.07	AAA.92030000.05
<b>Seal</b>	39.4"	78.7"	AAA.12010200.02	AAA.12010200.07	
	59"	118.1"	AAA.12010300.02	AAA.12010300.07	
	78.7"	157.5"	AAA.12010400.02	AAA.12010400.07	
	118.1"	236.2"	AAA.12010600.02	AAA.12010600.07	
<b>Bottom guiding track</b>	39.4"	39.4"	AAA.15000100.00		
	49.2"	49.2"	AAA.15000125.00		
	59"	59"	AAA.15000150.00		
	78.7"	78.7"	AAA.15000200.00		
	118.1"	118.1"	AAA.15000300.00		
	236.2"	236.2"	AAA.15000600.00		

Fittings selection

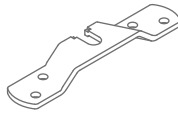

Transverse suspension	Min. door width	Min. door width ESSI	Reference
With 2 stoppers	13.9"	17.2"	AAA.20000000.00
With double-action softclose	22.8"	26.1"	AAA.20020000.00

Motorised set\*

Transverse suspension with motor	Min. door width	Min. door width ESSI	Length	Reference
Fittings	A-slide	27.6"	31.3"	AAA.20030000.00
Belt	Min. belt length = (4 x door width) + 7.9"		1968.5"	AK9.709.050
			787.4"	AK9.709.020
			393.7"	AK9.709.010
Remote control	for 1 channel			AM3.100.104.61
	for 4 channels			AM3.100.104.2.52

\* see p.68 for more information

Every fitting set comes with all the rollers or softclose mechanisms, suspension, guiding systems and stoppers you need.

Technical drawings

Wall mount 1.57"

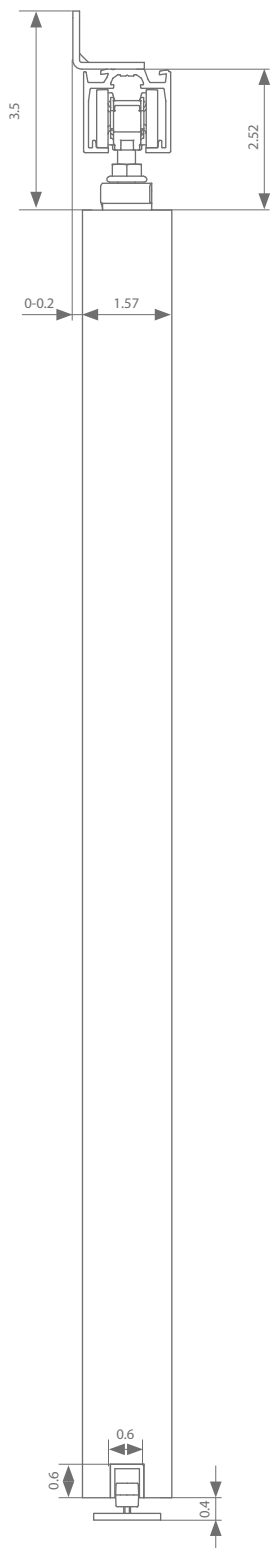

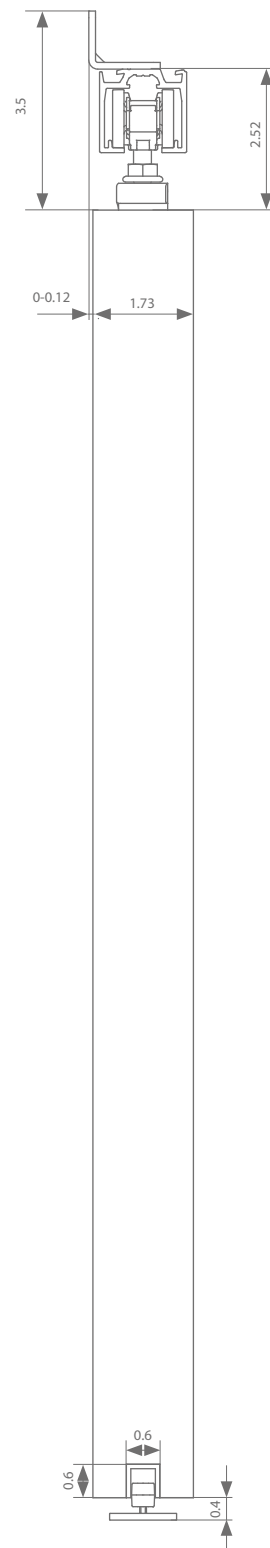

Wall mount 1.73"



Height adjustment: + - 0.16"

Profiles

	Max. door width	Length			
Running track	39.4"	78.7"	AAA.11000200.02	AAA.11000200.07	AAA.11000200.05
	59"	118.1"	AAA.11000300.02	AAA.11000300.07	AAA.11000300.05
	78.7"	157.5"	AAA.11000400.02	AAA.11000400.07	AAA.11000400.05
	118.1"	236.2"	AAA.11000600.02	AAA.11000600.07	AAA.11000600.05
ESSI®-module (optional)		3.94"	AAA.11010010.02	AAA.11010010.07	AAA.11010010.05
Wall bracket		every 19.7" needed	AAA.01000000.01		
Bottom guiding track	39.4"	39.4"	AAA.15000100.00		
	49.2"	49.2"	AAA.15000125.00		
	59"	59"	AAA.15000150.00		
	78.7"	78.7"	AAA.15000200.00		
	118.1"	118.1"	AAA.15000300.00		
	236.2"	236.2"	AAA.15000600.00		

Fittings selection

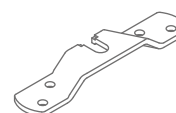
	Transverse suspension	Min. door width	Min. door width ESSI	Reference
	With 2 stoppers	13.9"	17.2"	AAA.20000000.00
	With double-action softclose	22.8"	26.1"	AAA.20020000.00

Motorised set\*

	Transverse suspension with motor	Min. door width	Min. door width ESSI	Length	Reference
Fittings	A-slide	27.6"	31.3"		AAA.20030000.00
Belt	Min. belt length = (4 x door width) + 7.9"			1968.5"	AK9.709.050
				787.4"	AK9.709.020
				393.7"	AK9.709.010
Remote control	for 1 channel				AM3.100.104.61
	for 4 channels				AM3.100.104.2.52

\* see p.68 for more information

Every fitting set comes with all the rollers or softclose mechanisms, suspension, guiding systems and stoppers you need.

Complete sets

	Max. door width	Length	
With 2 stoppers	39.4"	78.7"	AAA.31000200.02
With double-action softclose	39.4"	78.7"	AAA.31002200.02

Technical drawings

Wall mount 1.97"

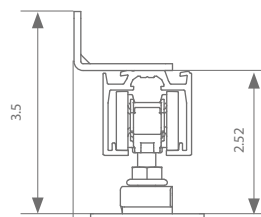

0-0.32 1.97

Wall mount 2.13"

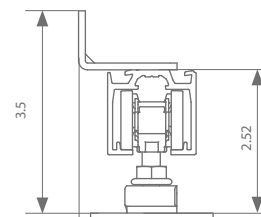

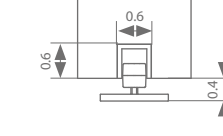

0-0.24 2.13

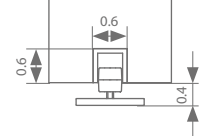

Height adjustment: + - 0.16"



Profiles

	Max. door width	Length			
Running track	39.4"	78.7"	AAA.11000200.02	AAA.11000200.07	AAA.11000200.05
	59"	118.1"	AAA.11000300.02	AAA.11000300.07	AAA.11000300.05
	78.7"	157.5"	AAA.11000400.02	AAA.11000400.07	AAA.11000400.05
	118.1"	236.2"	AAA.11000600.02	AAA.11000600.07	AAA.11000600.05
ESSI®-module (optional)		3.94"	AAA.11010010.02	AAA.11010010.07	AAA.11010010.05
Wall bracket		every 19.7" needed	AAA.01100000.01		
Bottom guiding track	39.4"	39.4"	AAA.15000100.00		
	49.2"	49.2"	AAA.15000125.00		
	59"	59"	AAA.15000150.00		
	78.7"	78.7"	AAA.15000200.00		
	118.1"	118.1"	AAA.15000300.00		
	236.2"	236.2"	AAA.15000600.00		

Fittings selection

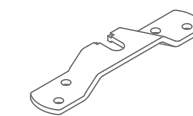

Transverse suspension	Min. door width	Min. door width ESSI	Reference
With 2 stoppers	13.9"	17.2"	AAA.20000000.00
With double-action softclose	22.8"	26.1"	AAA.20020000.00

Motorised set\*

Transverse suspension with motor	Min. door width	Min. door width ESSI	Length	Reference
Fittings A-slide	27.6"	31.3"		AAA.20030000.00
Belt	Min. belt length = (4 x door width) + 7.9"		1968.5"	AK9.709.050
			787.4"	AK9.709.020
			393.7"	AK9.709.010
Remote control	for 1 channel			AM3.100.104.61
	for 4 channels			AM3.100.104.2.52

\* see p.68 for more information

Every fitting set comes with all the rollers or softclose mechanisms, suspension, guiding systems and stoppers you need.

argenta Xperta wood  
compact wall mount 1.57/1.73 " without skirting

Technical drawings

Wall mount 1.57"

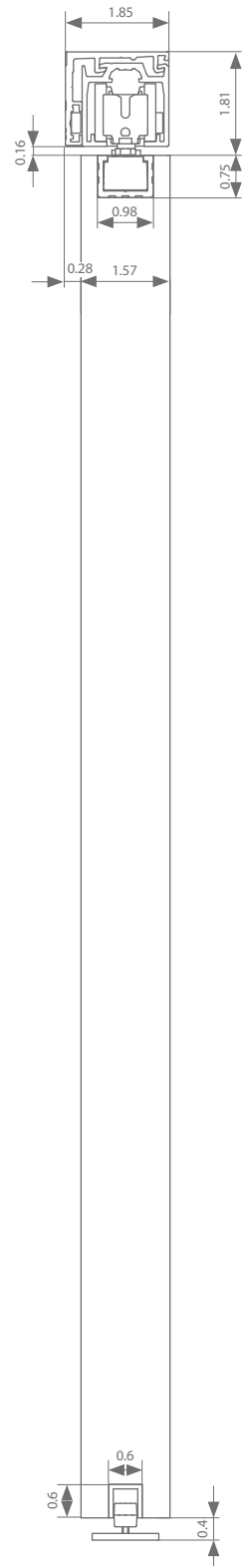

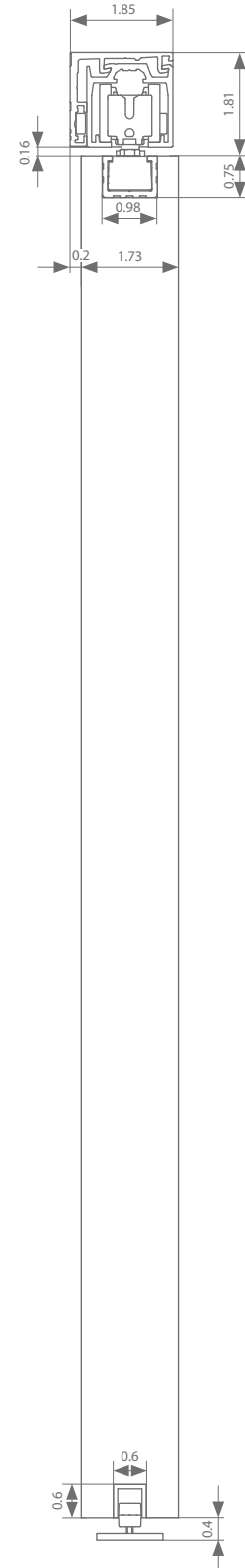

Wall mount 1.73"



Height adjustment: + 0/- 0.2"

assemble your set 

Profiles

	Max. door width	Length			
<b>Running track</b>	39.4"	78.7"	AAA.11000200.02	AAA.11000200.07	AAA.11000200.05
	59"	118.1"	AAA.11000300.02	AAA.11000300.07	AAA.11000300.05
	78.7"	157.5"	AAA.11000400.02	AAA.11000400.07	AAA.11000400.05
	118.1"	236.2"	AAA.11000600.02	AAA.11000600.07	AAA.11000600.05
<b>ESSI®-module (optional)</b>		3.94"	AAA.11010010.02	AAA.11010010.07	AAA.11010010.05
<b>Wall profile</b>	39.4"	78.7"	AAA.13000200.02	AAA.13000200.07	AAA.13000200.05
	59"	118.1"	AAA.13000300.02	AAA.13000300.07	AAA.13000300.05
	78.7"	157.5"	AAA.13000400.02	AAA.13000400.07	AAA.13000400.05
	118.1"	236.2"	AAA.13000600.02	AAA.13000600.07	AAA.13000600.05
<b>+ mounting set</b>		1 per 118.1"		AAA.13010000.07	
<b>Set of end caps</b>			AAA.93000000.02	AAA.93000000.07	AAA.93000000.05
<b>Suspension profile (optional)</b>		9.8**	AAA.14000025.00 (2 x)		
	39.4"	39.4"	AAA.14000100.00		
	49.2"	49.2"	AAA.14000125.00		
	59"	59"	AAA.14000150.00		
	78.7"	78.7"	AAA.14000200.00		
	118.1"	118.1"	AAA.14000300.00		
236.2"	236.2"	AAA.14000600.00			
<b>End cap suspension profile (optional)</b>			AAA.94000000.02	AAA.94000000.07	AAA.94000000.05
<b>Bottom guiding track</b>	39.4"	39.4"	AAA.15000100.00		
	49.2"	49.2"	AAA.15000125.00		
	59"	59"	AAA.15000150.00		
	78.7"	78.7"	AAA.15000200.00		
	118.1"	118.1"	AAA.15000300.00		
	236.2"	236.2"	AAA.15000600.00		

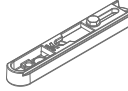
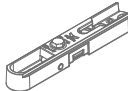

\* cannot be combined with ESSI\*

Fittings selection

	Compact suspension	Min. door width	Min. door width ESSI	Reference
	With 2 stoppers	14.1"	17.4"	AAA.20100000.00
	Double-action softclose	23.2"	26.1"	AAA.20120000.00
	With 2 stoppers	14.1"	17.4"	AAA.20200000.00
	Double-action softclose	23.2"	26.1"	AAA.20220000.00

Every fitting set comes with all the rollers or softclose mechanisms, suspension, guiding systems and stoppers you need.

Complete sets

	Max. door width	Length			
<b>With 2 stoppers</b>	39.4"	78.7"	AAA.33000200.02	AAA.33000200.07	AAA.33000200.05
<b>Double-action softclose</b>	39.4"	78.7"	AAA.33002200.02	AAA.33002200.07	AAA.33002200.05



argenta Xperta wood  
wall mount 1.57/1.73 " with skirting

Technical drawings

Wall mount 1.57"

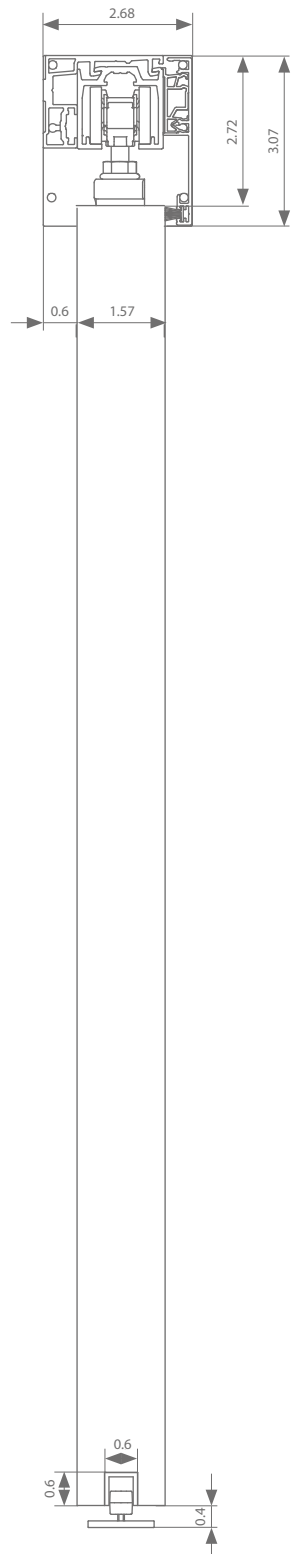

Wall mount 1.73"

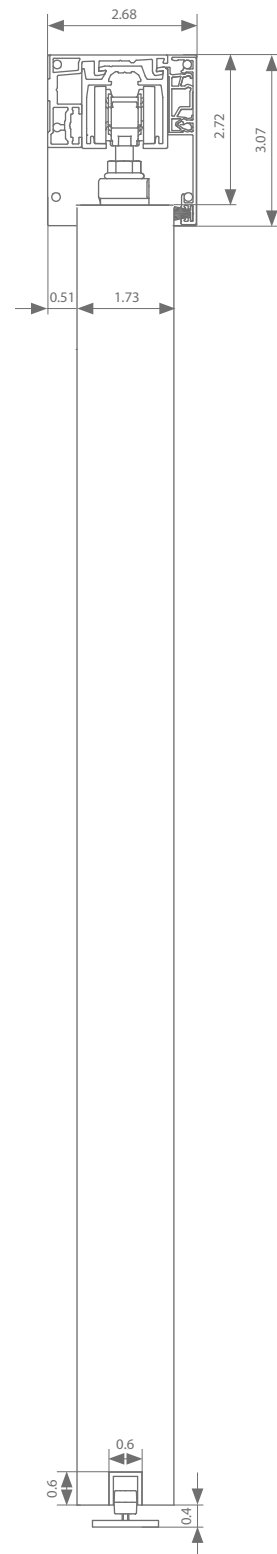

Height adjustment: + - 0.16"

assemble your set

Profiles

	Max. door width	Length			
Running track	39.4"	78.7"	AAA.11000200.02	AAA.11000200.07	AAA.11000200.05
	59"	118.1"	AAA.11000300.02	AAA.11000300.07	AAA.11000300.05
	78.7"	157.5"	AAA.11000400.02	AAA.11000400.07	AAA.11000400.05
	118.1"	236.2"	AAA.11000600.02	AAA.11000600.07	AAA.11000600.05
ESSI®-module (optional)		3.94"	AAA.11010010.02	AAA.11010010.07	AAA.11010010.05
Wall profile	39.4"	78.7"	AAA.13100200.02	AAA.13100200.07	AAA.13100200.05
	59"	118.1"	AAA.13100300.02	AAA.13100300.07	AAA.13100300.05
	78.7"	157.5"	AAA.13100400.02	AAA.13100400.07	AAA.13100400.05
	118.1"	236.2"	AAA.13100600.02	AAA.13100600.07	AAA.13100600.05
+ mounting set		1 per 118.1"	AAA.13010000.07		
Cover profile	39.4"	78.7"	AAA.12000200.02	AAA.12000200.07	AAA.12000200.05
	59"	118.1"	AAA.12000300.02	AAA.12000300.07	AAA.12000300.05
	78.7"	157.5"	AAA.12000400.02	AAA.12000400.07	AAA.12000400.05
	118.1"	236.2"	AAA.12000600.02	AAA.12000600.07	AAA.12000600.05
+ narrow clips 1 per metre of cover profile		3.94"		AAA.12010010.07	
Set of end caps			AAA.92010000.02	AAA.92010000.07	AAA.92010000.05
Seal	39.4"	78.7"	AAA.12010200.02	AAA.12010200.07	
	59"	118.1"	AAA.12010300.02	AAA.12010300.07	
	78.7"	157.5"	AAA.12010400.02	AAA.12010400.07	
	118.1"	236.2"	AAA.12010600.02	AAA.12010600.07	
Bottom guiding track	39.4"	39.4"	AAA.15000100.00		
	49.2"	49.2"	AAA.15000125.00		
	59"	59"	AAA.15000150.00		
	78.7"	78.7"	AAA.15000200.00		
	118.1"	118.1"	AAA.15000300.00		
	236.2"	236.2"	AAA.15000600.00		

Fittings selection

	Transverse suspension	Min. door width	Min. door width ESSI	Reference
	With 2 stoppers	13.9"	17.2"	AAA.20000000.00
	With double-action softclose	22.8"	26.1"	AAA.20020000.00

Motorised set\*

Transverse suspension with motor	Min. door width	Min. door width ESSI	Length	Reference
Fittings	A-slide**	27.6"	31.3"	AAA.20030000.00
Belt	Min. belt length = (4 x door width) + 7.9"		1968.5"	AK9.709.050
			787.4"	AK9.709.020
			393.7"	AK9.709.010
Remote control	for 1 channel			AM3.100.104.61
	for 4 channels			AM3.100.104.2.52

Every fitting set comes with all the rollers or softclose mechanisms, suspension, guiding systems and stoppers you need.

Complete sets

	Max. door width	Length			
With 2 stoppers	39.4"	78.7"	AAA.32010200.02	AAA.32010200.07	AAA.32010200.05
Double-action softclose	39.4"	78.7"	AAA.32012200.02	AAA.32012200.07	AAA.32012200.05

\* see p.68 for more information

\*\* For matching end caps and clips, see p. 17.

Technical drawings

Wall mount 1.57"

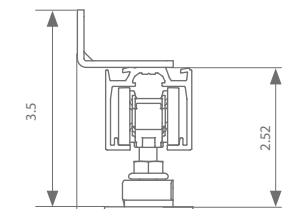

Wall mount 1.73"

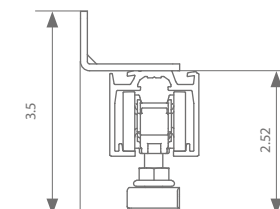

0-0.51" 1.57"

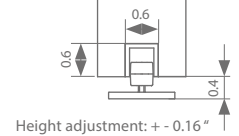

0-0.43" 1.73"

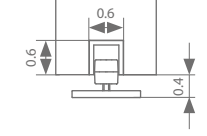

Height adjustment: + - 0.16"



Profiles

	Max. door width	Length			
<b>Running track</b>	39.4"	78.7"	AAA.11000200.02	AAA.11000200.07	AAA.11000200.05
	59"	118.1"	AAA.11000300.02	AAA.11000300.07	AAA.11000300.05
	78.7"	157.5"	AAA.11000400.02	AAA.11000400.07	AAA.11000400.05
	118.1"	236.2"	AAA.11000600.02	AAA.11000600.07	AAA.11000600.05
<b>ESSI®-module (optional)</b>		3.94"	AAA.11010010.02	AAA.11010010.07	AAA.11010010.05
<b>Wall bracket</b>		every 19.7" needed	AAA.01100000.01		
<b>Bottom guiding track</b>	39.4"	39.4"	AAA.15000100.00		
	49.2"	49.2"	AAA.15000125.00		
	59"	59"	AAA.15000150.00		
	78.7"	78.7"	AAA.15000200.00		
	118.1"	118.1"	AAA.15000300.00		
	236.2"	236.2"	AAA.15000600.00		

Fittings selection

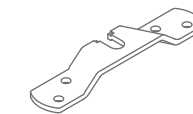

Transverse suspension	Min. door width	Min. door width ESSI	Reference
With 2 stoppers	13.9"	17.2"	AAA.20000000.00
With double-action softclose	22.8"	26.1"	AAA.20020000.00

Motorised set\*

Transverse suspension with motor	Min. door width	Min. door width ESSI	Length	Reference
Fittings	A-slide	27.6"	31.3"	AAA.20030000.00
Belt	Min. belt length = (4 x door width) + 7.9"		1968.5"	AK9.709.050
			787.4"	AK9.709.020
			393.7"	AK9.709.010
Remote control	for 1 channel			AM3.100.104.61
	for 4 channels			AM3.100.104.2.52

\* see p.68 for more information

Every fitting set comes with all the rollers or softclose mechanisms, suspension, guiding systems and stoppers you need.

argenta Xperta wood  
compact wall mount 1.57/1.73 with skirting

Technical drawings

Wall mount 1.57"

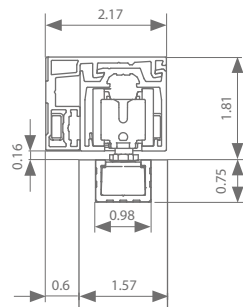

Wall mount 1.73"

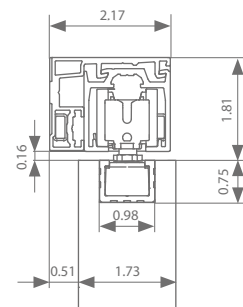

Height adjustment: + 0/- 0.2"

assemble your set

Profiles

	Max. door width	Length			
Running track	39.4"	78.7"	AAA.11000200.02	AAA.11000200.07	AAA.11000200.05
	59"	118.1"	AAA.11000300.02	AAA.11000300.07	AAA.11000300.05
	78.7"	157.5"	AAA.11000400.02	AAA.11000400.07	AAA.11000400.05
	118.1"	236.2"	AAA.11000600.02	AAA.11000600.07	AAA.11000600.05
ESSI®-module (optional)		3.94"	AAA.11010010.02	AAA.11010010.07	AAA.11010010.05
Wall profile	39.4"	78.7"	AAA.13100200.02	AAA.13100200.07	AAA.13100200.05
	59"	118.1"	AAA.13100300.02	AAA.13100300.07	AAA.13100300.05
	78.7"	157.5"	AAA.13100400.02	AAA.13100400.07	AAA.13100400.05
	118.1"	236.2"	AAA.13100600.02	AAA.13100600.07	AAA.13100600.05
+ mounting set		1 per 118.1"		AAA.13010000.07	
Set of end caps			AAA.93100000.02	AAA.93100000.07	AAA.93100000.05
Suspension profile (optional)		9.8"*	AAA.1400025.00 (2 x)		
	39.4"	39.4"	AAA.14000100.00		
	49.2"	49.2"	AAA.14000125.00		
	59"	59"	AAA.14000150.00		
	78.7"	78.7"	AAA.14000200.00		
	118.1"	118.1"	AAA.14000300.00		
	236.2"	236.2"	AAA.14000600.00		
End cap suspension profile (optional)			AAA.94000000.02	AAA.94000000.07	AAA.94000000.05
Bottom guiding track	39.4"	39.4"	AAA.15000100.00		
	49.2"	49.2"	AAA.15000125.00		
	59"	59"	AAA.15000150.00		
	78.7"	78.7"	AAA.15000200.00		
	118.1"	118.1"	AAA.15000300.00		
	236.2"	236.2"	AAA.15000600.00		

\* cannot be combined with ESSI\*

Fittings selection

	Compact suspension	Min. door width	Min. door width ESSI	Reference
	With 2 stoppers	14.1"	17.4"	AAA.20100000.00
	Double-action softclose	23.2"	26.1"	AAA.20120000.00
	With 2 stoppers	14.1"	17.4"	AAA.20200000.00
	Double-action softclose	23.2"	26.1"	AAA.20220000.00

Every fitting set comes with all the rollers or softclose mechanisms, suspension, guiding systems and stoppers you need.

Complete sets

	Max. door width	Length			
With 2 stoppers	39.4"	78.7"	AAA.33100200.02	AAA.33100200.07	AAA.33100200.05
Double-action softclose	39.4"	78.7"	AAA.33102200.02	AAA.33102200.07	AAA.33102200.05



## argenta **XPERTA AUTOCLOSE**

What are the benefits ?

- Closes softly through self-braking weights and softclose mechanism
- The system is always concealed behind the door

Features

- Suitable for ceiling or wall mounting
- The minimum required space between the door and wall is 13"
- Maximum door width = door height - 33,0.2"

Info

The **AK0.192** Autoclose set can be combined with the following fitting set:

Fittings	Reference
Standard fix with 2 softcloses	AAA.20020000.00





## Xperta 220 lbs **FLUSH INTO CEILING**

The Xperta invisible is the ultimate solution for ceiling high applications where the profile is seamlessly integrated into a suspended ceiling. The profile can be finished with standard plasterboard, or whatever skirting that might be chosen. The compact suspension ensures the clearance between door and ceiling is limited to minimum 0.16" for an extremely sleek finish.

PROFILE LENGTH

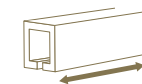

78.7 | 118.1 |  
157.5 | 236.2"

INSTALLATION



DOOR WEIGHT

MAX.  
**220**  
LBS



grey anodised  
aluminium

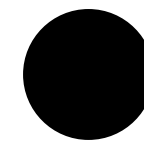

black anodised  
aluminium



white matte coating  
RAL 9016

Technical drawings

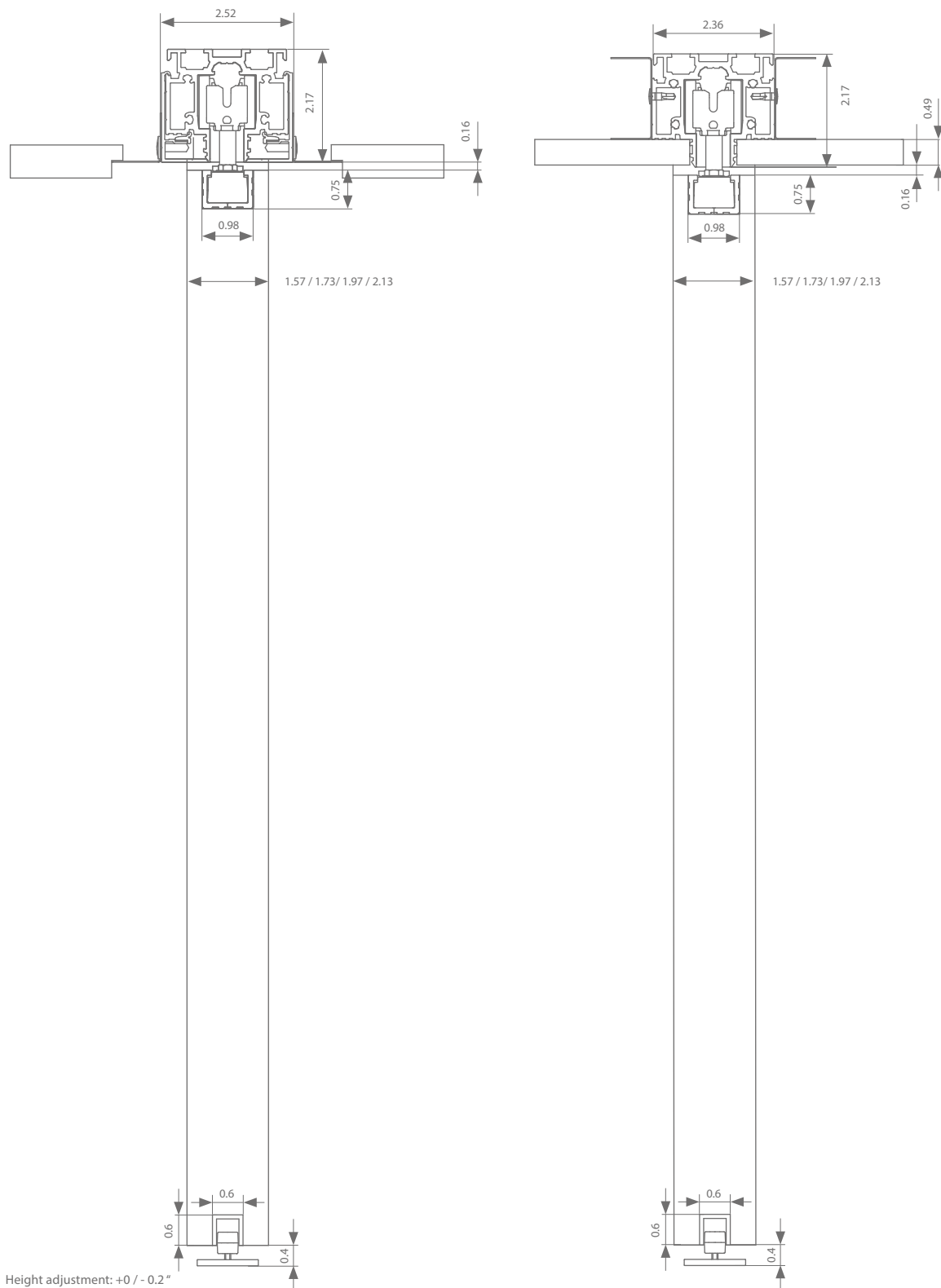

For suspended ceiling (1+2)

For plasterboard (1)



Height adjustment: +0 / - 0.2"

Profiles

	Max. door width	Length			
Running track (1)	39.4"	78.7"	AAA.11100200.02	AAA.11100200.07	AAA.11100200.05
	59"	118.1"	AAA.11100300.02	AAA.11100300.07	AAA.11100300.05
	78.7"	157.5"	AAA.11100400.02	AAA.11100400.07	AAA.11100400.05
	118.1"	236.2"	AAA.11100600.02	AAA.11100600.07	AAA.11100600.05
ESSI®-module		3.94"	AAA.11110010.02	AAA.11110010.07	AAA.11110010.05
2 x extra cover profile for suspended ceilings (2)	39.4"	78.7"			AAA.11120200.05
	59"	118.1"			AAA.11120300.05
	78.7"	157.5"			AAA.11120400.05
	118.1"	236.2"			AAA.11120600.05
+ 2 x for ESSI					AAA.11113010.05
Suspension profile (optional)	39.4"	39.4"	AAA.14000100.00		
	49.2"	49.2"	AAA.14000125.00		
	59"	59"	AAA.14000150.00		
	78.7"	78.7"	AAA.14000200.00		
	118.1"	118.1"	AAA.14000300.00		
End cap suspension profile (optional)				AAA.94000000.02	AAA.94000000.07
					AAA.94000000.05
	39.4"	39.4"	AAA.15000100.00		
	49.2"	49.2"	AAA.15000125.00		
Bottom guiding track	59"	59"	AAA.15000150.00		
	78.7"	78.7"	AAA.15000200.00		
	118.1"	118.1"	AAA.15000300.00		
	236.2"	236.2"	AAA.15000600.00		

Fittings selection

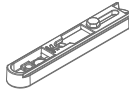
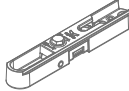



Compact suspension		Min. door width	Min. door width ESSI	Reference
	With 2 stoppers	14.1"	17.4"	AAA.20100000.00
	Double-action softclose	23.2"	26.1"	AAA.20120000.00
	With 2 stoppers	14.1"	17.4"	AAA.20200000.00
	Double-action softclose	23.2"	26.1"	AAA.20220000.00

Every fitting set comes with all the rollers or softclose mechanisms, suspension, guiding systems and stoppers you need.

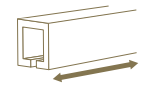

## Xperta 220 lbs **SYMMETRIC**

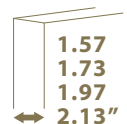
In a symmetric configuration, both doors are connected by a reinforced dented belt that coordinates simultaneous movement. User comfort is guaranteed: you can open and close both door panels with just one finger! Ceiling and wall mounting are both possible within this setup.

PROFILE LENGTH	INSTALLATION	DOOR THICKNESS	DOOR WEIGHT
 <b>78.7   118.1   157.5   236.2"</b>		 <b>1.57 1.73 1.97 2.13"</b>	 <b>MAX. 220 LBS</b>



anodised aluminium    black textured coating RAL 9005    white textured coating RAL 9016



Technical drawings

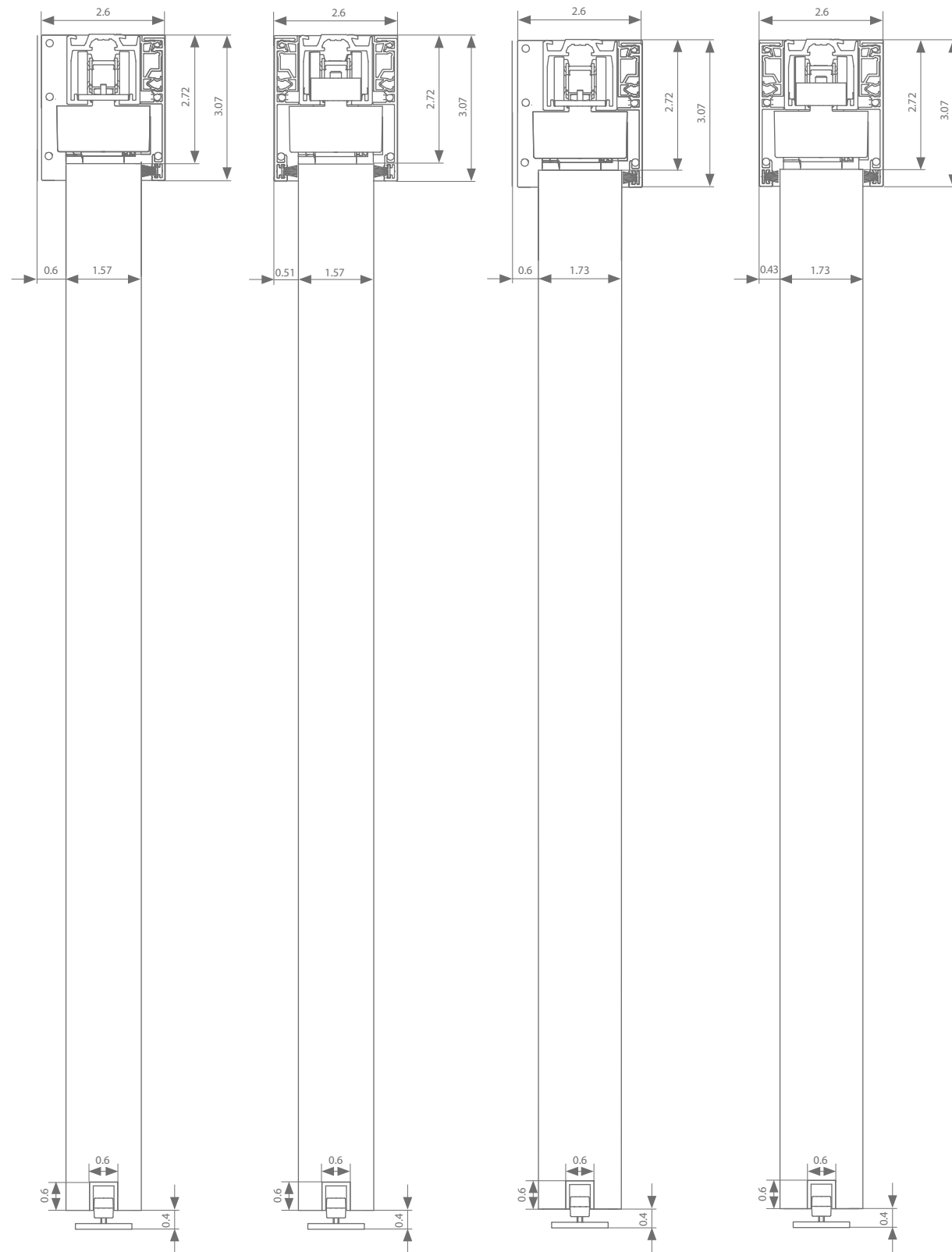

Ceiling mount 1.57"

Ceiling mount 1.73"



Height adjustment: + - 0.16"

Profiles

	Max. door width	Length			
Running track	19.7"	78.7"	AAA.11000200.02	AAA.11000200.07	AAA.11000200.05
	29.5"	118.1"	AAA.11000300.02	AAA.11000300.07	AAA.11000300.05
	39.4"	157.5"	AAA.11000400.02	AAA.11000400.07	AAA.11000400.05
	59"	236.2"	AAA.11000600.02	AAA.11000600.07	AAA.11000600.05
ESSI®-module (optional)		3.94"	AAA.11010010.02	AAA.11010010.07	AAA.11010010.05
Cover profile	19.7"	78.7"	AAA.12000200.02	AAA.12000200.07	AAA.12000200.05
	29.5"	118.1"	AAA.12000300.02	AAA.12000300.07	AAA.12000300.05
	39.4"	157.5"	AAA.12000400.02	AAA.12000400.07	AAA.12000400.05
	59"	236.2"	AAA.12000600.02	AAA.12000600.07	AAA.12000600.05
+ narrow clips 1 per metre of cover profile		3.94"		AAA.12010010.07	
Set of end caps			AAA.92020000.02	AAA.92020000.07	AAA.92020000.05
Seal	19.7"	78.7"	AAA.12010200.02	AAA.12010200.07	
	29.5"	118.1"	AAA.12010300.02	AAA.12010300.07	
	39.4"	157.5"	AAA.12010400.02	AAA.12010400.07	
	59"	236.2"	AAA.12010600.02	AAA.12010600.07	
Bottom guiding track	39.4"	39.4"	AAA.15000100.00		
	49.2"	49.2"	AAA.15000125.00		
	59"	59"	AAA.15000150.00		
	78.7"	78.7"	AAA.15000200.00		
	118.1"	118.1"	AAA.15000300.00		
236.2"	236.2"	AAA.15000600.00			

Fittings selection

Transverse suspension	Min. door width	Min. door width ESSI	Length	Reference
Symmetric	16.8"	20.4"		AAA.20001000.00
Belt			1968.5"	AK9.709.050
			787.4"	AK9.709.020
			393.7"	AK9.709.010

Motorised set\*

Transverse suspension with motor	Min. door width	Min. door width ESSI	Length	Reference
Fittings	A-slide** (max. 132.3 lbs/door)	21.3"	23.3"	AAA.20031000.00
Belt			1968.5"	AK9.709.050
			787.4"	AK9.709.020
			393.7"	AK9.709.010
Remote control	for 1 channel			AM3.100.104.61
	for 4 channels			AM3.100.104.252

\* see p.68 for more information

\*\* For matching end caps and clips, see p.41.

Every fitting set comes with all the rollers or softclose mechanisms, suspension, guiding systems and stoppers you need.



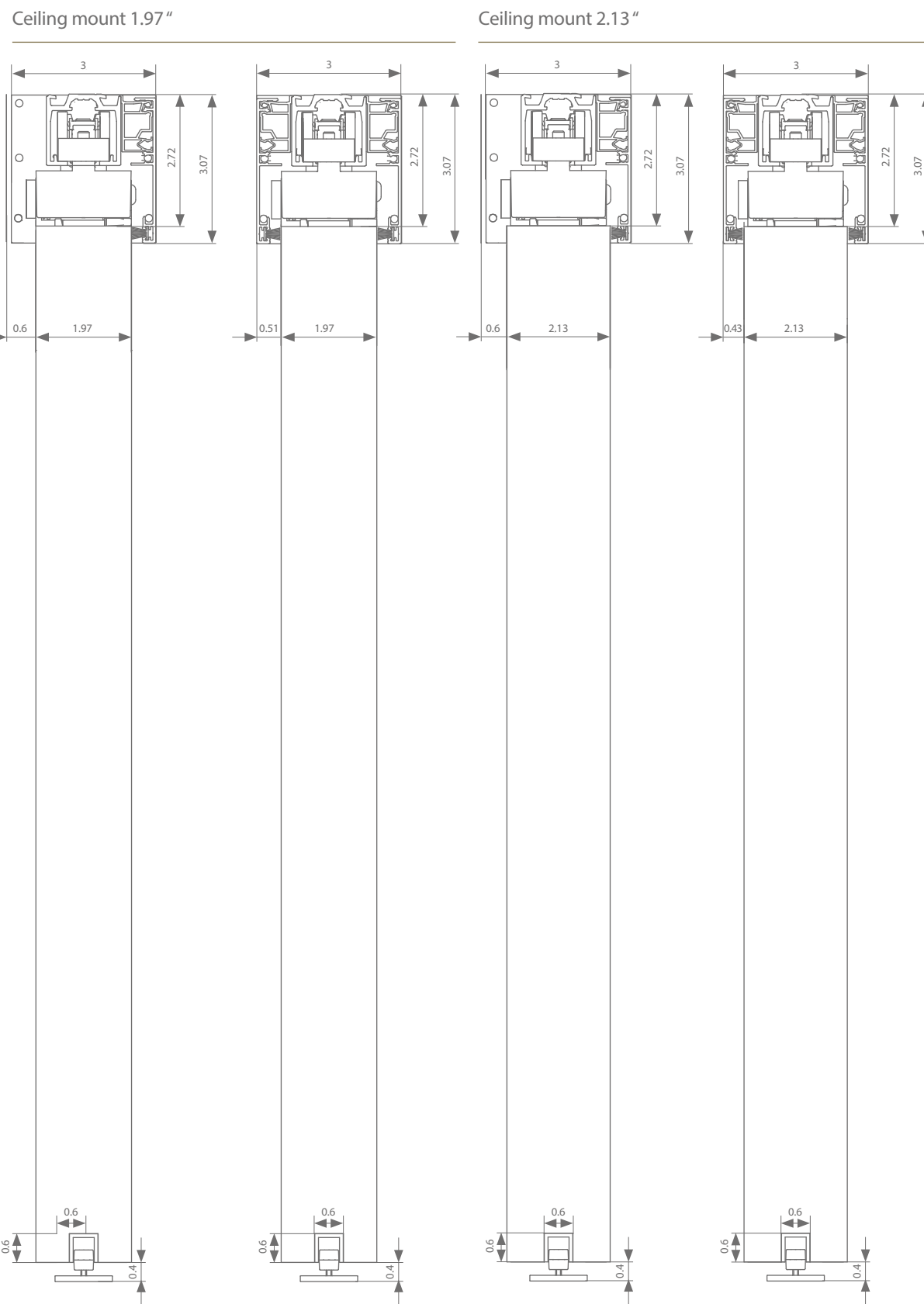

Technical drawings



Height adjustment: + - 0.16"

Profiles

	Max. door width	Length			
<b>Running track</b>	19.7"	78.7"	AAA.11000200.02	AAA.11000200.07	AAA.11000200.05
	29.5"	118.1"	AAA.11000300.02	AAA.11000300.07	AAA.11000300.05
	39.4"	157.5"	AAA.11000400.02	AAA.11000400.07	AAA.11000400.05
	59"	236.2"	AAA.11000600.02	AAA.11000600.07	AAA.11000600.05
<b>ESSI®-module (optional)</b>		3.94"	AAA.11010010.02	AAA.11010010.07	AAA.11010010.05
<b>Cover profile</b>	19.7"	78.7"	AAA.12000200.02	AAA.12000200.07	AAA.12000200.05
	29.5"	118.1"	AAA.12000300.02	AAA.12000300.07	AAA.12000300.05
	39.4"	157.5"	AAA.12000400.02	AAA.12000400.07	AAA.12000400.05
	59"	236.2"	AAA.12000600.02	AAA.12000600.07	AAA.12000600.05
<b>+ wide clips</b> 1 per metre of cover profile		3.94"		AAA.12020010.07	AAA.12020100.07
<b>Set of end caps</b>			AAA.92040000.02	AAA.92040000.07	AAA.92040000.05
<b>Seal</b>	19.7"	78.7"	AAA.12010200.02	AAA.12010200.07	
	29.5"	118.1"	AAA.12010300.02	AAA.12010300.07	
	39.4"	157.5"	AAA.12010400.02	AAA.12010400.07	
	59"	236.2"	AAA.12010600.02	AAA.12010600.07	
<b>Bottom guiding track</b>	39.4"	39.4"	AAA.15000100.00		
	49.2"	49.2"	AAA.15000125.00		
	59"	59"	AAA.15000150.00		
	78.7"	78.7"	AAA.15000200.00		
	118.1"	118.1"	AAA.15000300.00		
236.2"	236.2"	AAA.15000600.00			

Fittings selection

Transverse suspension	Min. door width	Min. door width ESSI	Length	Reference
Symmetric	16.8"	20.4"		AAA.20001000.00
Belt			1968.5"	AK9.709.050
		Min. belt length = (8 x door width) + 7.9"	787.4"	AK9.709.020
			393.7"	AK9.709.010

Motorised set\*

Transverse suspension with motor	Min. door width	Min. door width ESSI	Length	Reference
Fittings	A-slide (max. 132.3 lbs/door)	21.3"	23.3"	AAA.20031000.00
Belt			1968.5"	AK9.709.050
		Min. belt length = (8 x door width) + 7.9"	787.4"	AK9.709.020
			393.7"	AK9.709.010
Remote control	for 1 channel			AM3.100.104.61
	for 4 channels			AM3.100.104.252

\* see p.68 for more information

Every fitting set comes with all the rollers or softclose mechanisms, suspension, guiding systems and stoppers you need.

Technical drawings

Wall mount 1.57"

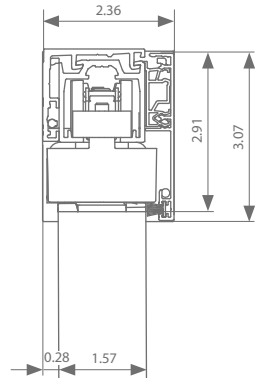

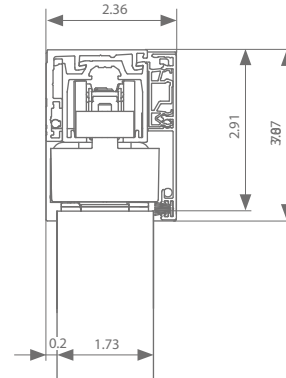

Wall mount 1.73"



Height adjustment: + - 0.16"

Profiles

	Max. door width	Length			
<b>Running track</b>	19.7"	78.7"	AAA.11000200.02	AAA.11000200.07	AAA.11000200.05
	29.5"	118.1"	AAA.11000300.02	AAA.11000300.07	AAA.11000300.05
	39.4"	157.5"	AAA.11000400.02	AAA.11000400.07	AAA.11000400.05
	59"	236.2"	AAA.11000600.02	AAA.11000600.07	AAA.11000600.05
<b>ESSI®-module (optional)</b>		3.94"	AAA.11010010.02	AAA.11010010.07	AAA.11010010.05
<b>Wall profile</b>	19.7"	78.7"	AAA.13000200.02	AAA.13000200.07	AAA.13000200.05
	29.5"	118.1"	AAA.13000300.02	AAA.13000300.07	AAA.13000300.05
	39.4"	157.5"	AAA.13000400.02	AAA.13000400.07	AAA.13000400.05
	59"	236.2"	AAA.13000600.02	AAA.13000600.07	AAA.13000600.05
<b>+ mounting set</b>	1 per 3 meter	3.94"		AAA.13010000.07	
<b>Cover profile</b>	19.7"	78.7"	AAA.12000200.02	AAA.12000200.07	AAA.12000200.05
	29.5"	118.1"	AAA.12000300.02	AAA.12000300.07	AAA.12000300.05
	39.4"	157.5"	AAA.12000400.02	AAA.12000400.07	AAA.12000400.05
	59"	236.2"	AAA.12000600.02	AAA.12000600.07	AAA.12000600.05
<b>+ narrow clips</b> 1 per metre of cover profile		3.94"		AAA.12010010.07	
<b>Set of end caps</b>			AAA.92000000.02	AAA.92000000.07	AAA.92000000.05
<b>Seal</b>	19.7"	78.7"	AAA.12010200.02	AAA.12010200.07	
	29.5"	118.1"	AAA.12010300.02	AAA.12010300.07	
	39.4"	157.5"	AAA.12010400.02	AAA.12010400.07	
	59"	236.2"	AAA.12010600.02	AAA.12010600.07	
<b>Bottom guiding track</b>	39.4"	39.4"	AAA.15000100.00		
	49.2"	49.2"	AAA.15000125.00		
	59"	59"	AAA.15000150.00		
	78.7"	78.7"	AAA.15000200.00		
	118.1"	118.1"	AAA.15000300.00		
	236.2"	236.2"	AAA.15000600.00		

Fittings selection

Transverse suspension	Min. door width	Min. door width ESSI	Length	Reference
Symmetric	16.8"	20.4"		AAA.20001000.00
Belt			1968.5"	AK9.709.050
			787.4"	AK9.709.020
			393.7"	AK9.709.010

Motorised set\*

Transverse suspension with motor	Min. door width	Min. door width ESSI	Length	Reference
Fittings	A-slide** (max. 132.3 lbs/door)	21.3"	23.3"	AAA.20031000.00
Belt			1968.5"	AK9.709.050
			787.4"	AK9.709.020
			393.7"	AK9.709.010
Remote control	for 1 channel			AM3.100.104.61
	for 4 channels			AM3.100.104.2.52

\* see p.68 for more information

Every fitting set comes with all the rollers or softclose mechanisms, suspension, guiding systems and stoppers you need.

\*\* Cannot be combined with cover profiles and end caps

# wall mount symmetric 1.97/2.13" without skirting

## Technical drawings

Wall mount 1.97"

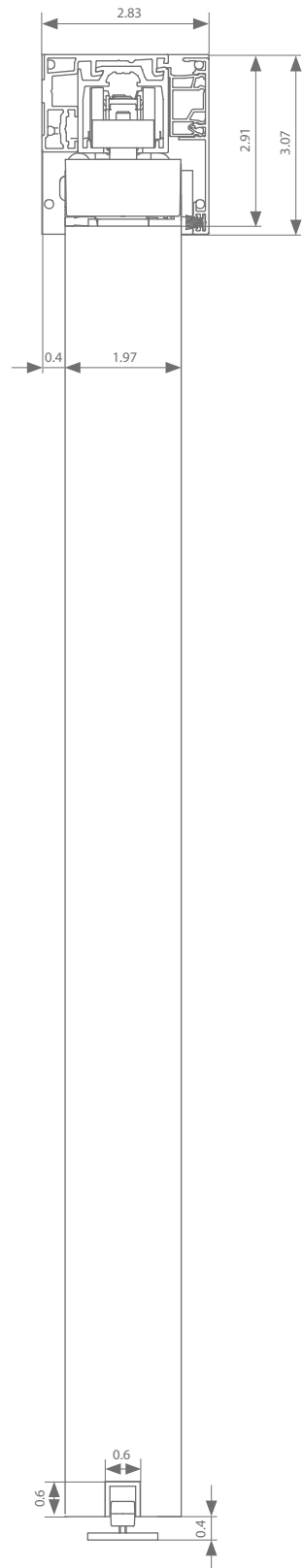

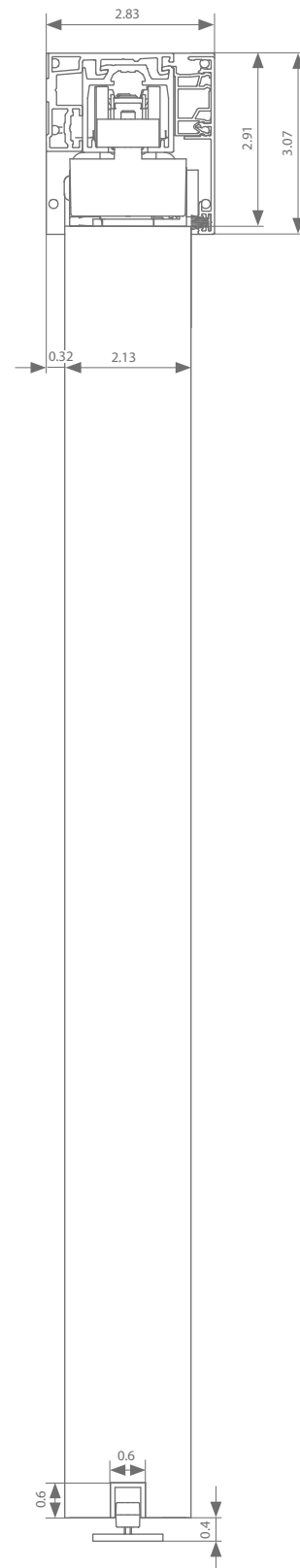

Wall mount 2.13"



Height adjustment: + - 0.16"

## Profiles

assemble your set 

	Max. door width	Length			
<b>Running track</b>	19.7"	78.7"	AAA.11000200.02	AAA.11000200.07	AAA.11000200.05
	29.5"	118.1"	AAA.11000300.02	AAA.11000300.07	AAA.11000300.05
	39.4"	157.5"	AAA.11000400.02	AAA.11000400.07	AAA.11000400.05
	59"	236.2"	AAA.11000600.02	AAA.11000600.07	AAA.11000600.05
<b>ESSI®-module (optional)</b>		3.94"	AAA.11010010.02	AAA.11010010.07	AAA.11010010.05
<b>Wall profile</b>	19.7"	78.7"	AAA.13100200.02	AAA.13100200.07	AAA.13100200.05
	29.5"	118.1"	AAA.13100300.02	AAA.13100300.07	AAA.13100300.05
	39.4"	157.5"	AAA.13100400.02	AAA.13100400.07	AAA.13100400.05
	59"	236.2"	AAA.13100600.02	AAA.13100600.07	AAA.13100600.05
<b>+ mounting set</b>			AAA.13010000.07		
<b>Cover profile</b>	19.7"	78.7"	AAA.12000200.02	AAA.12000200.07	AAA.12000200.05
	29.5"	118.1"	AAA.12000300.02	AAA.12000300.07	AAA.12000300.05
	39.4"	157.5"	AAA.12000400.02	AAA.12000400.07	AAA.12000400.05
	59"	236.2"	AAA.12000600.02	AAA.12000600.07	AAA.12000600.05
<b>+ wide clips</b> 1 per metre of cover profile		3.94"		AAA.12020010.07	AAA.12020100.07
<b>Set of end caps</b>			AAA.92030000.02	AAA.92030000.07	AAA.92030000.05
<b>Seal</b>	19.7"	78.7"	AAA.12010200.02	AAA.12010200.07	
	29.5"	118.1"	AAA.12010300.02	AAA.12010300.07	
	39.4"	157.5"	AAA.12010400.02	AAA.12010400.07	
	59"	236.2"	AAA.12010600.02	AAA.12010600.07	
<b>Bottom guiding track</b>	39.4"	39.4"	AAA.15000100.00		
	49.2"	49.2"	AAA.15000125.00		
	59"	59"	AAA.15000150.00		
	78.7"	78.7"	AAA.15000200.00		
	118.1"	118.1"	AAA.15000300.00		
	236.2"	236.2"	AAA.15000600.00		

## Fittings selection

Transverse suspension	Min. door width	Min. door width ESSI	Length	Reference
Symmetric	16.8"	20.4"		AAA.20001000.00
Belt			1968.5"	AK9.709.050
			787.4"	AK9.709.020
			393.7"	AK9.709.010

## Motorised set\*

Transverse suspension with motor	Min. door width	Min. door width ESSI	Length	Reference
Fittings	A-slide (max. 132.3 lbs/door)	21.3"	23.3"	AAA.20031000.00
Belt			1968.5"	AK9.709.050
			787.4"	AK9.709.020
			393.7"	AK9.709.010
Remote control	for 1 channel			AM3.100.104.61
	for 4 channels			AM3.100.104.252

\* see p.68 for more information

Every fitting set comes with all the rollers or softclose mechanisms, suspension, guiding systems and stoppers you need.

Technical drawings

Wall mount 1.57"

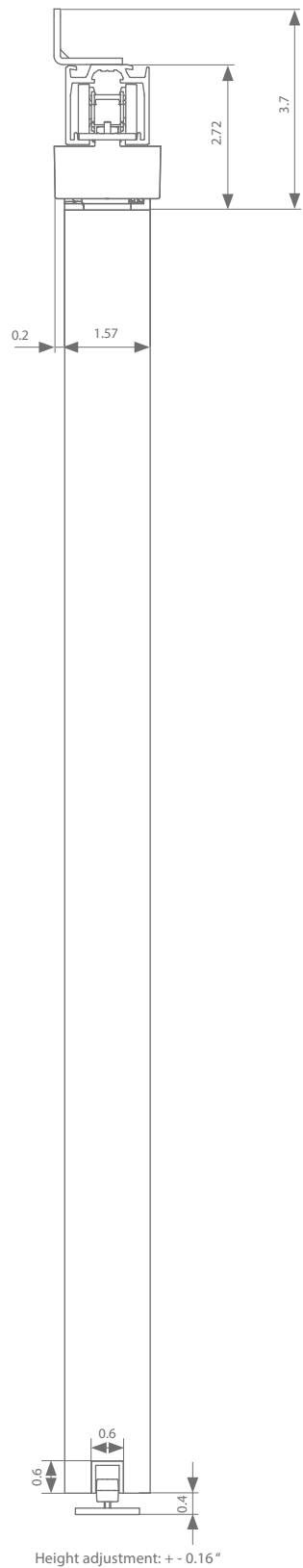

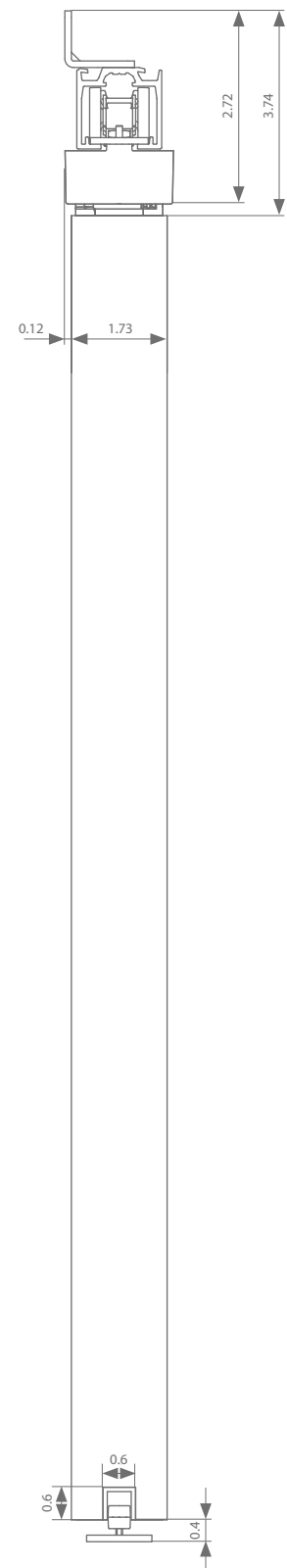

Wall mount 1.73"



Height adjustment: + - 0.16"

Profiles

	Max. door width	Length			
Running track	19.7"	78.7"	AAA.11000200.02	AAA.11000200.07	AAA.11000200.05
	29.5"	118.1"	AAA.11000300.02	AAA.11000300.07	AAA.11000300.05
	39.4"	157.5"	AAA.11000400.02	AAA.11000400.07	AAA.11000400.05
	59"	236.2"	AAA.11000600.02	AAA.11000600.07	AAA.11000600.05
ESSI®-module (optional)		3.94"	AAA.11010010.02	AAA.11010010.07	AAA.11010010.05
Wall bracket		every 19.7" needed	AAA.01000000.01		
Bottom guiding track	39.4"	39.4"	AAA.15000100.00		
	49.2"	49.2"	AAA.15000125.00		
	59"	59"	AAA.15000150.00		
	78.7"	78.7"	AAA.15000200.00		
	118.1"	118.1"	AAA.15000300.00		
	236.2"	236.2"	AAA.15000600.00		

Fittings selection

Transverse suspension	Min. door width	Min. door width ESSI	Length	Reference
Symmetric	16.8"	20.4"		AAA.20001000.00
Belt	Min. belt length = (8 x door width) + 7.9"		1968.5"	AK9.709.050
			787.4"	AK9.709.020
			393.7"	AK9.709.010

Motorised set\*

Transverse suspension with motor	Min. door width	Min. door width ESSI	Length	Reference
Fittings	A-slide (max. 132.3 lbs/door)	21.3"	23.3"	AAA.20031000.00
Belt	Min. belt length = (8 x door width) + 7.9"		1968.5"	AK9.709.050
			787.4"	AK9.709.020
			393.7"	AK9.709.010
Remote control	for 1 channel			AM3.100.104.61
	for 4 channels			AM3.100.104.252

\* see p.68 for more information

Every fitting set comes with all the rollers or softclose mechanisms, suspension, guiding systems and stoppers you need.



Technical drawings

Wall mount 1.97"

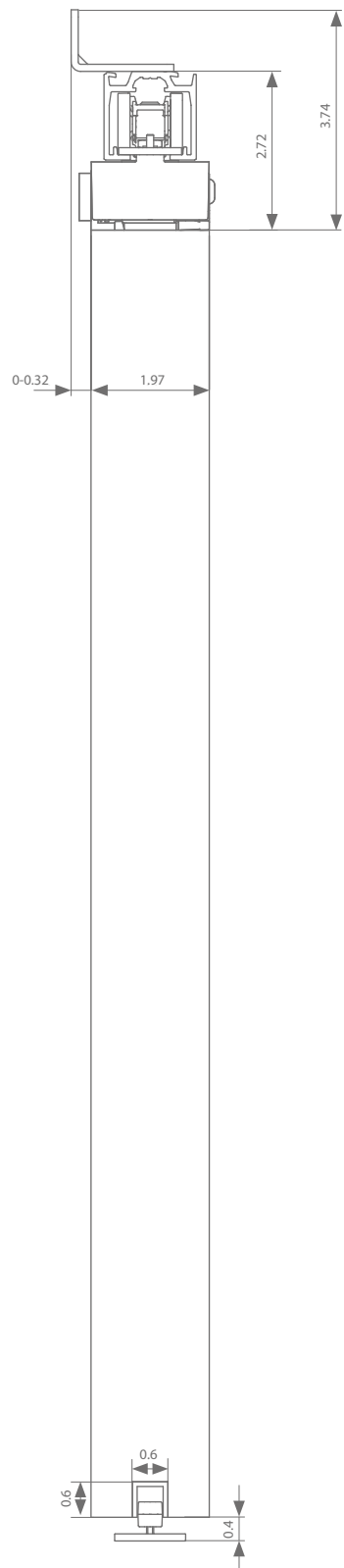

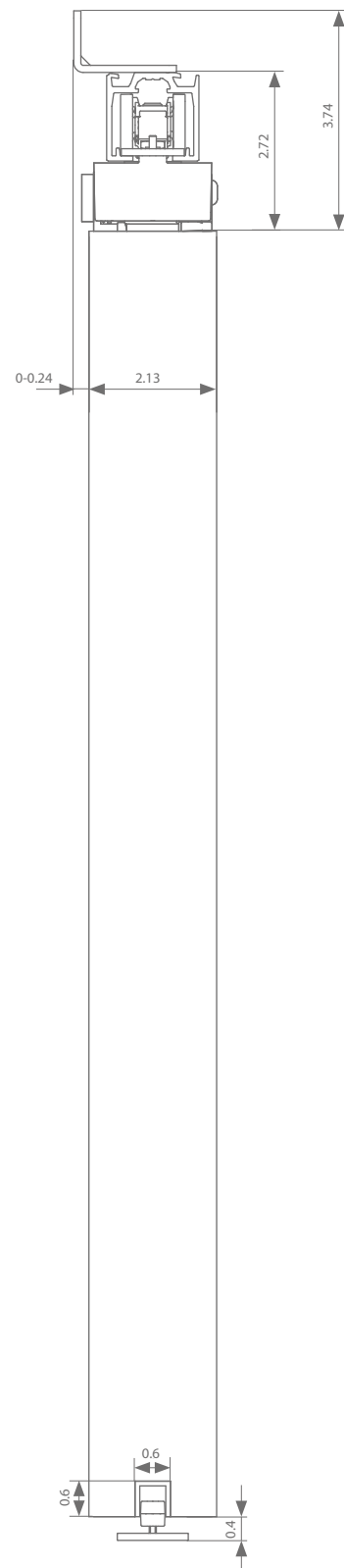

Wall mount 2.13"



Height adjustment: + - 0.16"

Profiles

	Max. door width	Length			
Running track	19.7"	78.7"	AAA.11000200.02	AAA.11000200.07	AAA.11000200.05
	29.5"	118.1"	AAA.11000300.02	AAA.11000300.07	AAA.11000300.05
	39.4"	157.5"	AAA.11000400.02	AAA.11000400.07	AAA.11000400.05
	59"	236.2"	AAA.11000600.02	AAA.11000600.07	AAA.11000600.05
ESSI®-module (optional)		3.94"	AAA.11010010.02	AAA.11010010.07	AAA.11010010.05
Wall bracket		every 19.7" needed	AAA.01100000.01		
Bottom guiding track	39.4"	39.4"	AAA.15000100.00		
	49.2"	49.2"	AAA.15000125.00		
	59"	59"	AAA.15000150.00		
	78.7"	78.7"	AAA.15000200.00		
	118.1"	118.1"	AAA.15000300.00		
	236.2"	236.2"	AAA.15000600.00		

Fittings selection

Transverse suspension	Min. door width	Min. door width ESSI	Length	Reference
Symmetric	16.8"	20.4"		AAA.20001000.00
Belt			1968.5"	AK9.709.050
		Min. belt length = (8 x door width) + 7.9"	787.4"	AK9.709.020
			393.7"	AK9.709.010

Motorised set\*

Transverse suspension with motor		Min. door width	Min. door width ESSI	Length	Reference
Fittings	A-slide (max. 132.3 lbs/door)	21.3"	23.3"		AAA.20031000.00
Belt				1968.5"	AK9.709.050
		Min. belt length = (8 x door width) + 7.9"		787.4"	AK9.709.020
				393.7"	AK9.709.010
Remote control	for 1 channel				AM3.100.104.61
	for 4 channels				AM3.100.104.2.52

\* see p.68 for more information

Every fitting set comes with all the rollers or softclose mechanisms, suspension, guiding systems and stoppers you need.

argenta Xperta wood  
wall mount symmetric 1.57/1.73" with skirting

Technical drawings

Wall mount 1.57"

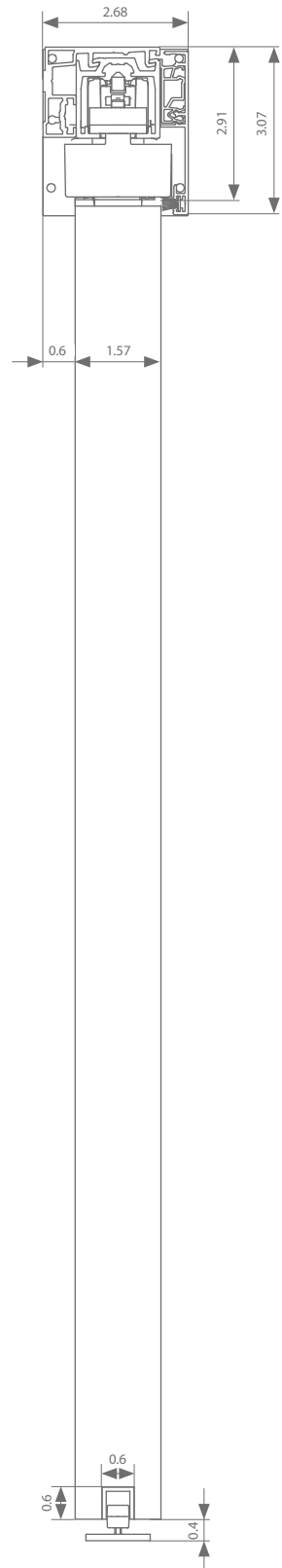

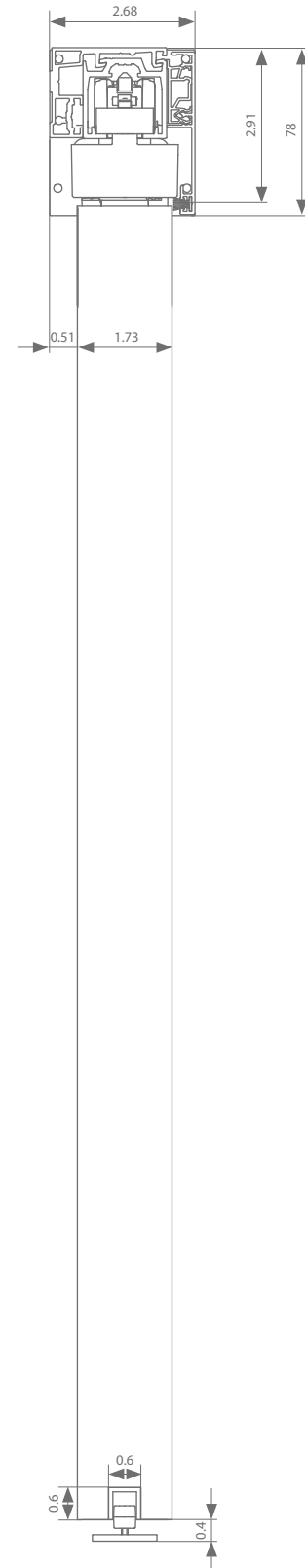

Height adjustment: + - 0.16"

Wall mount 1.73"



Profiles

assemble your set 

	Max. door width	Length			
<b>Running track</b>	19.7"	78.7"	AAA.11000200.02	AAA.11000200.07	AAA.11000200.05
	29.5"	118.1"	AAA.11000300.02	AAA.11000300.07	AAA.11000300.05
	39.4"	157.5"	AAA.11000400.02	AAA.11000400.07	AAA.11000400.05
	59"	236.2"	AAA.11000600.02	AAA.11000600.07	AAA.11000600.05
<b>ESSI®-module (optional)</b>		3.94"	AAA.11010010.02	AAA.11010010.07	AAA.11010010.05
<b>Wall profile</b>	19.7"	78.7"	AAA.13100200.02	AAA.13100200.07	AAA.13100200.05
	29.5"	118.1"	AAA.13100300.02	AAA.13100300.07	AAA.13100300.05
	39.4"	157.5"	AAA.13100400.02	AAA.13100400.07	AAA.13100400.05
	59"	236.2"	AAA.13100600.02	AAA.13100600.07	AAA.13100600.05
<b>+ mounting set</b>	1 per 3 meter	3.94"		AAA.13010000.07	
<b>Cover profile</b>	19.7"	78.7"	AAA.12000200.02	AAA.12000200.07	AAA.12000200.05
	29.5"	118.1"	AAA.12000300.02	AAA.12000300.07	AAA.12000300.05
	39.4"	157.5"	AAA.12000400.02	AAA.12000400.07	AAA.12000400.05
	59"	236.2"	AAA.12000600.02	AAA.12000600.07	AAA.12000600.05
<b>+ narrow clips</b> 1 per metre of cover profile		3.94"		AAA.12010010.07	
<b>Set of end caps</b>			AAA.92010000.02	AAA.92010000.07	AAA.92010000.05
<b>Seal</b>	19.7"	78.7"	AAA.12010200.02	AAA.12010200.07	
	29.5"	118.1"	AAA.12010300.02	AAA.12010300.07	
	39.4"	157.5"	AAA.12010400.02	AAA.12010400.07	
	59"	236.2"	AAA.12010600.02	AAA.12010600.07	
<b>Bottom guiding track</b>	39.4"	39.4"	AAA.15000100.00		
	49.2"	49.2"	AAA.15000125.00		
	59"	59"	AAA.15000150.00		
	78.7"	78.7"	AAA.15000200.00		
	118.1"	118.1"	AAA.15000300.00		
	236.2"	236.2"	AAA.15000600.00		

Fittings selection

Transverse suspension	Min. door width	Min. door width ESSI	Length	Reference
Symmetric	16.8"	20.4"		AAA.20001000.00
Belt			1968.5"	AK9.709.050
			787.4"	AK9.709.020
			393.7"	AK9.709.010

Motorised set\*

Transverse suspension with motor	Min. door width	Min. door width ESSI	Length	Reference
Fittings	A-slide** (max. 132.3 lbs/door)	21.3"	23.3"	AAA.20031000.00
Belt			1968.5"	AK9.709.050
			787.4"	AK9.709.020
			393.7"	AK9.709.010
Remote control	for 1 channel			AM3.100.104.61
	for 4 channels			AM3.100.104.2.52

\* see p.68 for more information



\*\* For matching end caps and clips, see p.45.

Every fitting set comes with all the rollers or softclose mechanisms, suspension, guiding systems and stoppers you need.

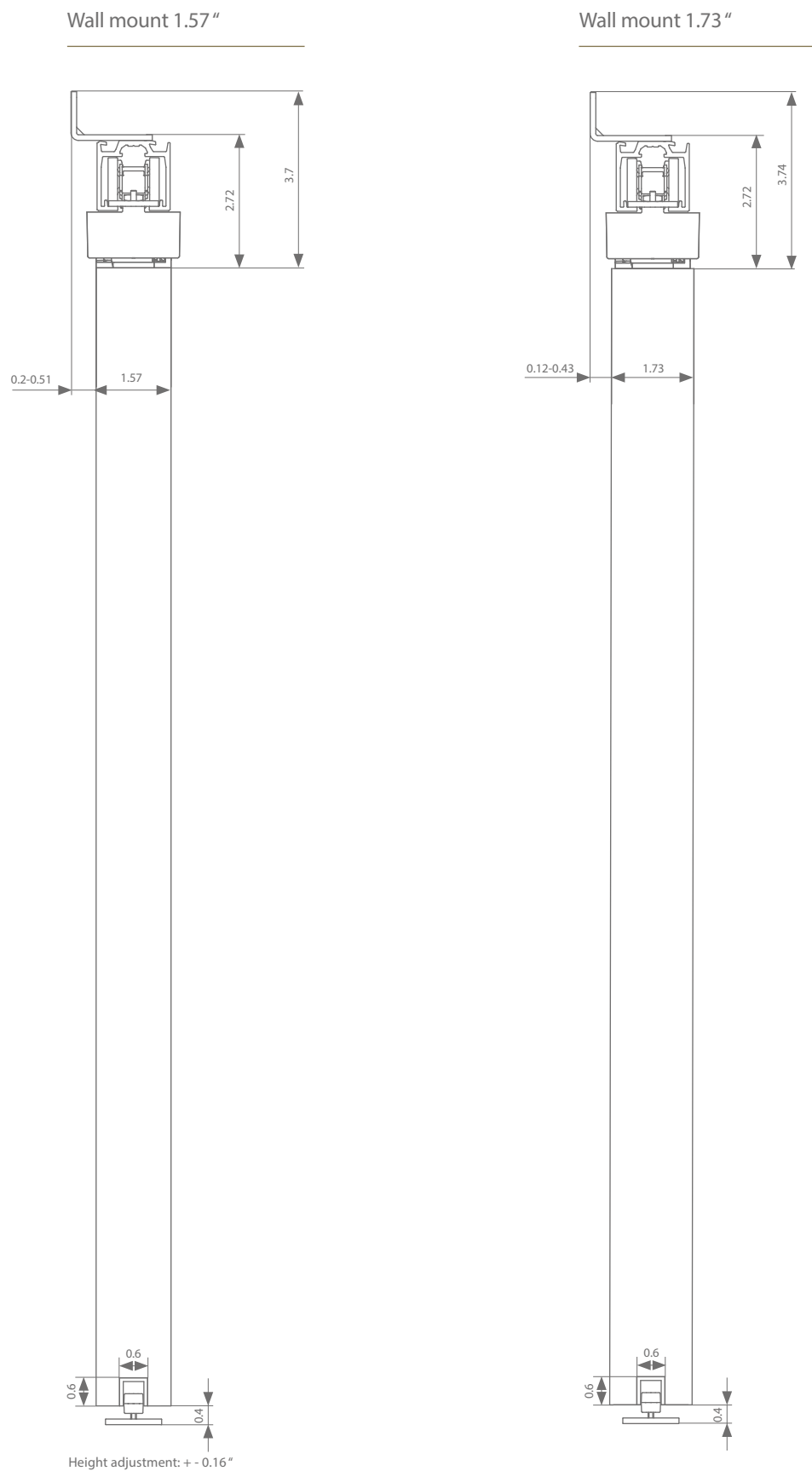
Technical drawings



Profiles

	Max. door width	Length			
Running track	19.7"	78.7"	AAA.11000200.02	AAA.11000200.07	AAA.11000200.05
	29.5"	118.1"	AAA.11000300.02	AAA.11000300.07	AAA.11000300.05
	39.4"	157.5"	AAA.11000400.02	AAA.11000400.07	AAA.11000400.05
	59"	236.2"	AAA.11000600.02	AAA.11000600.07	AAA.11000600.05
	ESSI®-module (optional)	3.94"	AAA.11010010.02	AAA.11010010.07	AAA.11010010.05
Wall bracket	every 19.7" needed	AAA.01100000.01			
Bottom guiding track	39.4"	39.4"	AAA.15000100.00		
	49.2"	49.2"	AAA.15000125.00		
	59"	59"	AAA.15000150.00		
	78.7"	78.7"	AAA.15000200.00		
	118.1"	118.1"	AAA.15000300.00		
	236.2"	236.2"	AAA.15000600.00		

Fittings selection

Transverse suspension	Min. door width	Min. door width ESSI	Length	Reference
Symmetric	16.8"	20.4"		AAA.20001000.00
Belt	Min. belt length = (8 x door width) + 7.9"		1968.5"	AK9.709.050
			787.4"	AK9.709.020
			393.7"	AK9.709.010

Motorised set\*

Transverse suspension with motor	Min. door width	Min. door width ESSI	Length	Reference
Fittings	A-slide (max. 132.3 lbs/door)	21.3"	23.3"	AAA.20031000.00
Belt	Min. belt length = (8 x door width) + 7.9"		1968.5"	AK9.709.050
			787.4"	AK9.709.020
			393.7"	AK9.709.010
Remote control	for 1 channel			AM3.100.104.61
	for 4 channels			AM3.100.104.2.52

\* see p.68 for more information

Every fitting set comes with all the rollers or softclose mechanisms, suspension, guiding systems and stoppers you need.



## Xperta 220 lbs **TELESCOPIC**

This silent system is available in two versions, one with a belt and one with noggles. In the belt version, all doors move simultaneously so they reach their end point at the same time. In the second version, the noggles move one panel after another.

PROFILE LENGTH

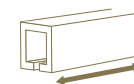

78.7 | 118.1 |  
157.5 | 236.2"

INSTALLATION



DOOR THICKNESS

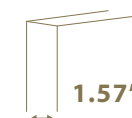

1.57"

DOOR WEIGHT



MAX.  
**220**  
LBS



anodised aluminium

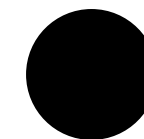

black textured coating  
RAL 9005



white textured coating  
RAL 9016

argenta Xperta wood  
dual telescopic ceiling mount 1.57"

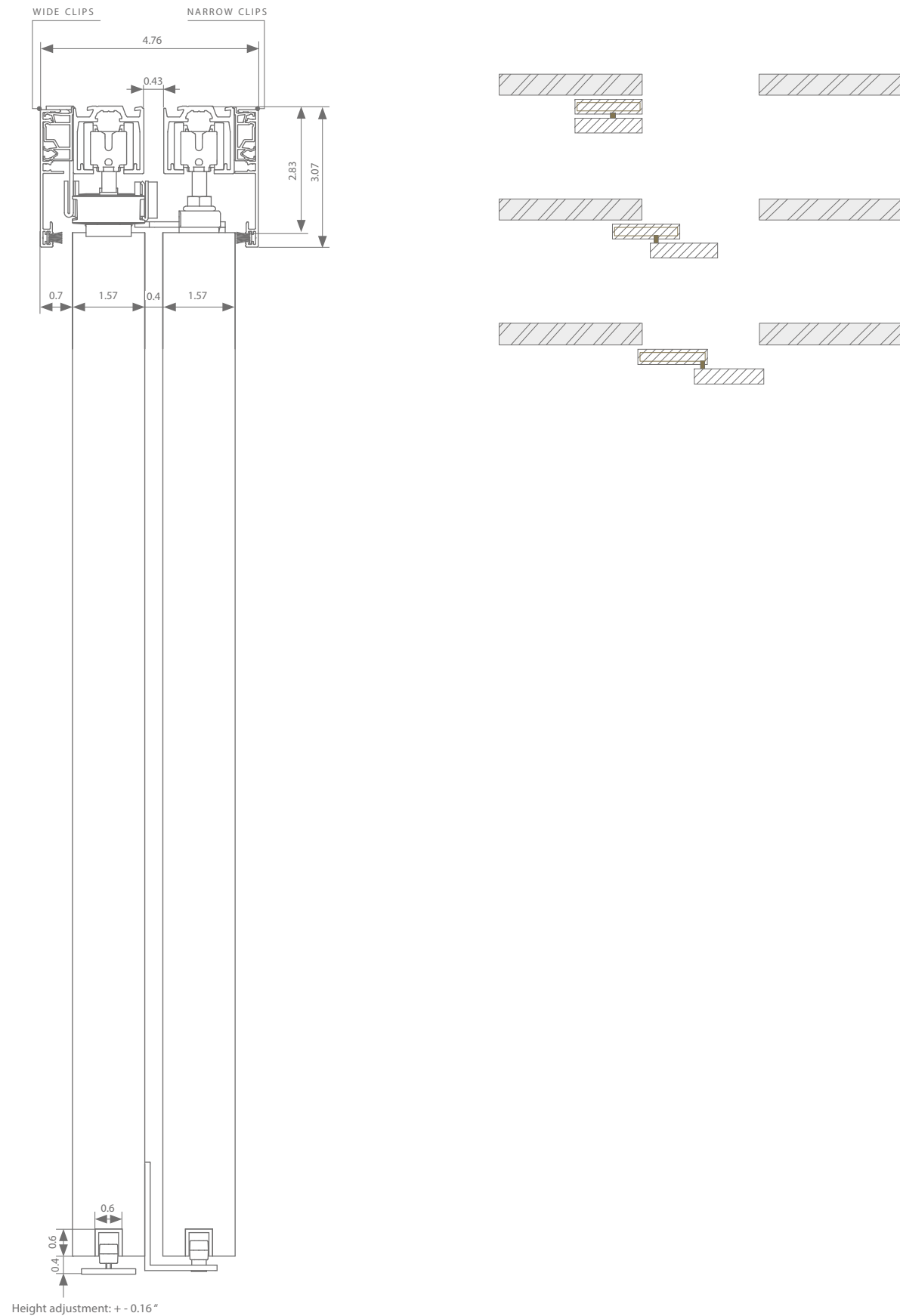

Technical drawings



Height adjustment: + - 0.16"

assemble your set 

Profiles

	Max. door width	Length			
2 x running track	26.2"	78.7"	AAA.11000200.02	AAA.11000200.07	AAA.11000200.05
	39.4"	118.1"	AAA.11000300.02	AAA.11000300.07	AAA.11000300.05
	52.5"	157.5"	AAA.11000400.02	AAA.11000400.07	AAA.11000400.05
	78.7"	236.2"	AAA.11000600.02	AAA.11000600.07	AAA.11000600.05
2xESSI®-module (optional)		3.94"	AAA.11010010.02	AAA.11010010.07	AAA.11010010.05
2 x cover profile	26.2"	78.7"	AAA.12000200.02	AAA.12000200.07	AAA.12000200.05
	39.4"	118.1"	AAA.12000300.02	AAA.12000300.07	AAA.12000300.05
	52.5"	157.5"	AAA.12000400.02	AAA.12000400.07	AAA.12000400.05
	78.7"	236.2"	AAA.12000600.02	AAA.12000600.07	AAA.12000600.05
+ narrow clips 1 per metre of cover profile		3.94"		AAA.12010010.07	
+ wide clips 1 per metre of cover profile		3.94"		AAA.12020010.07	AAA.12020100.07
2 x seal	26.2"	78.7"	AAA.12010200.02	AAA.12010200.07	
	39.4"	118.1"	AAA.12010300.02	AAA.12010300.07	
	52.5"	157.5"	AAA.12010400.02	AAA.12010400.07	
	78.7"	236.2"	AAA.12010600.02	AAA.12010600.07	
2 x bottom guiding track	39.4"	39.4"	AAA.15000100.00		
	49.2"	49.2"	AAA.15000125.00		
	59"	59"	AAA.15000150.00		
	78.7"	78.7"	AAA.15000200.00		
	118.1"	118.1"	AAA.15000300.00		
	236.2"	236.2"	AAA.15000600.00		

Fittings selection

	Transverse suspension		Min. door width	Min. door width ESSI	Length	Reference
	2 x telescopic	1 x necessary	16.8"	18.6"		AAA.20003000.00
	Belt				1968.5" 787.4" 393.7"	AK9.709.050 AK9.709.020 AK9.709.010
					Min. belt length = (2 x door width) + 15.7"	

Motorised set\*

	Transverse suspension with motor		Min. door width	Min. door width ESSI	Length	Reference
Fittings	A-slide** (max. 132.3 lbs/door)		26.9"	28"		AAA.20033000.00
Belt					1968.5" 787.4" 393.7"	AK9.709.050 AK9.709.020 AK9.709.010
					Min. belt length = (8 x door width) + 23.6"	
	Remote control					AM3.100.104.61
						AM3.100.104.252

\* see p.68 for more information

Every fitting set comes with all the rollers or softclose mechanisms, suspension, guiding systems and stoppers you need.

\*\* Cannot be combined with cover profiles and end caps



Technical drawings

Parallel ceiling mount 1

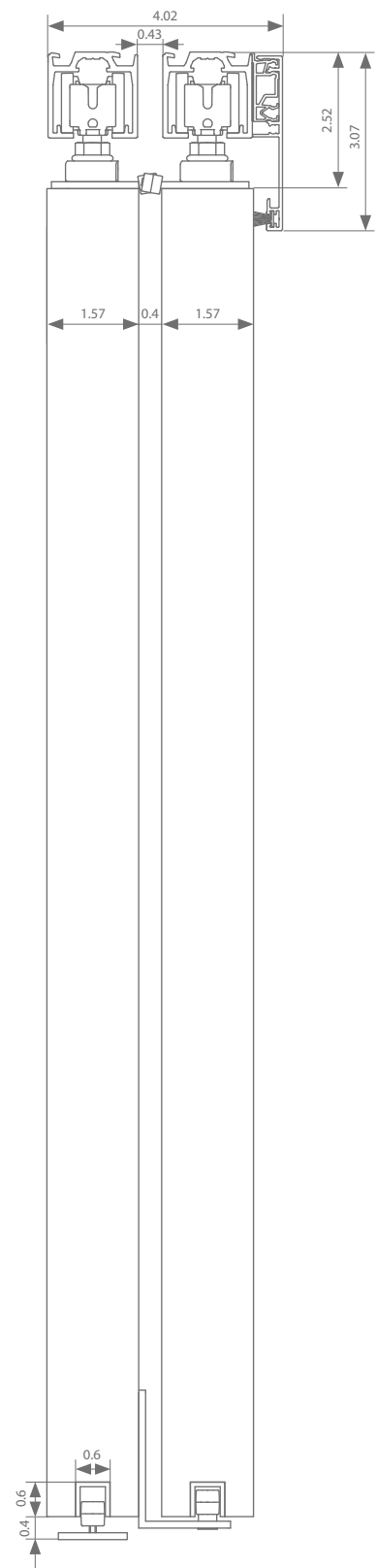

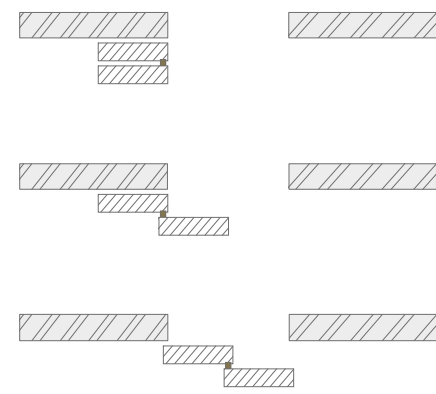
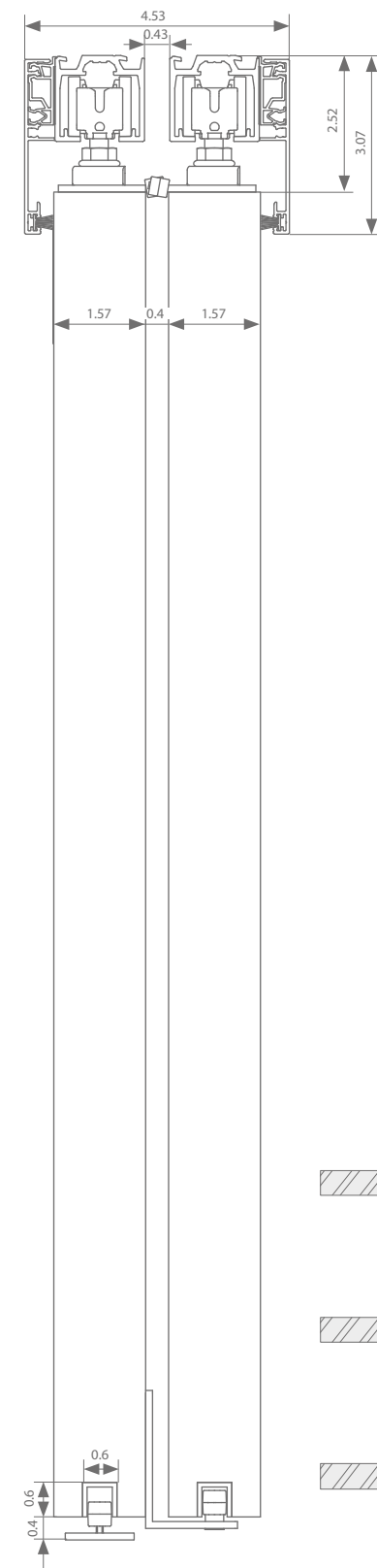

Parallel ceiling mount 2



Height adjustment: + - 0.16"

Profiles

	Max. door width	Length			
2 x running track	26.2"	78.7"	AAA.11000200.02	AAA.11000200.07	AAA.11000200.05
	39.4"	118.1"	AAA.11000300.02	AAA.11000300.07	AAA.11000300.05
	52.5"	157.5"	AAA.11000400.02	AAA.11000400.07	AAA.11000400.05
	78.7"	236.2"	AAA.11000600.02	AAA.11000600.07	AAA.11000600.05
2x ESSI®-module (optional)		3.94"	AAA.11010010.02	AAA.11010010.07	AAA.11010010.05
2 x cover profile	26.2"	78.7"	AAA.12000200.02	AAA.12000200.07	AAA.12000200.05
	39.4"	118.1"	AAA.12000300.02	AAA.12000300.07	AAA.12000300.05
	52.5"	157.5"	AAA.12000400.02	AAA.12000400.07	AAA.12000400.05
	78.7"	236.2"	AAA.12000600.02	AAA.12000600.07	AAA.12000600.05
+ narrow clips 1 per metre of cover profile		3.94"		AAA.12010010.07	
2 x seal	26.2"	78.7"	AAA.12010200.02	AAA.12010200.07	
	39.4"	118.1"	AAA.12010300.02	AAA.12010300.07	
	52.5"	157.5"	AAA.12010400.02	AAA.12010400.07	
	78.7"	236.2"	AAA.12010600.02	AAA.12010600.07	
2 x bottom guiding track	39.4"	39.4"	AAA.15000100.00		
	49.2"	49.2"	AAA.15000125.00		
	59"	59"	AAA.15000150.00		
	78.7"	78.7"	AAA.15000200.00		
	118.1"	118.1"	AAA.15000300.00		
	236.2"	236.2"	AAA.15000600.00		

Fittings selection

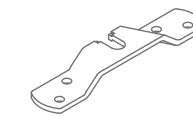



Transverse suspension		Min. door width	Min. door width ESSI	Reference
With 2 stoppers	2 x necessary	13"	16.7"	AAA.20000000.00
With double-action softclose	2 x necessary	26"	27.3"	AAA.20020000.00
+ 2 x parallel	1 x necessary			AAA.20002000.00

Every fitting set comes with all the rollers or softclose mechanisms, suspension, guiding systems and stoppers you need.

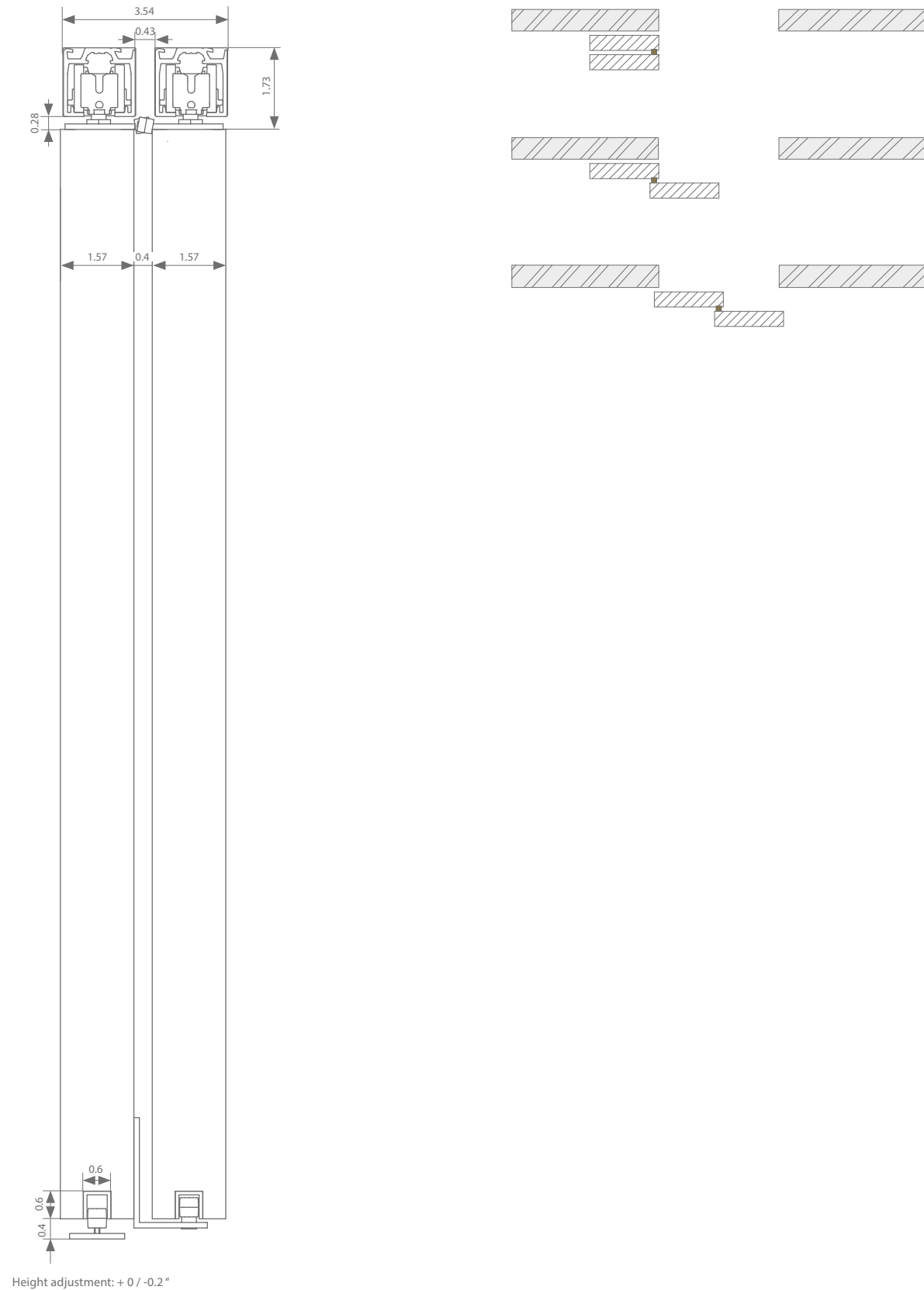
Technical drawings



Profiles

	Max. door width	Length			
2 x running track	26.2"	78.7"	AAA.11000200.02	AAA.11000200.07	AAA.11000200.05
	39.4"	118.1"	AAA.11000300.02	AAA.11000300.07	AAA.11000300.05
	52.5"	157.5"	AAA.11000400.02	AAA.11000400.07	AAA.11000400.05
	78.7"	236.2"	AAA.11000600.02	AAA.11000600.07	AAA.11000600.05
2 x ESSI®-module (optional)		3.94"	AAA.11010010.02	AAA.11010010.07	AAA.11010010.05
2 x bottom guiding track	39.4"	39.4"	AAA.15000100.00		
	49.2"	49.2"	AAA.15000125.00		
	59"	59"	AAA.15000150.00		
	78.7"	78.7"	AAA.15000200.00		
	118.1"	118.1"	AAA.15000300.00		
	236.2"	236.2"	AAA.15000600.00		

Fittings selection

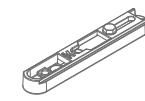
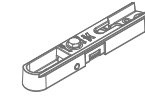

Transverse suspension		Min. door width	Min. door width ESSI	Reference	
	With 2 stoppers	2 x necessary	13.6"	17.6"	AAA.20100000.00
	Double-action softclose	2 x necessary	26.5"	28"	AAA.20120000.00
	With 2 stoppers	2 x necessary	13.6"	17.6"	AAA.20200000.00
	Double-action softclose	2 x necessary	26.5"	28"	AAA.20220000.00
+ 2 x parallel		1 x necessary		AAA.20002000.00	

Every fitting set comes with all the rollers or softclose mechanisms, suspension, guiding systems and stoppers you need.

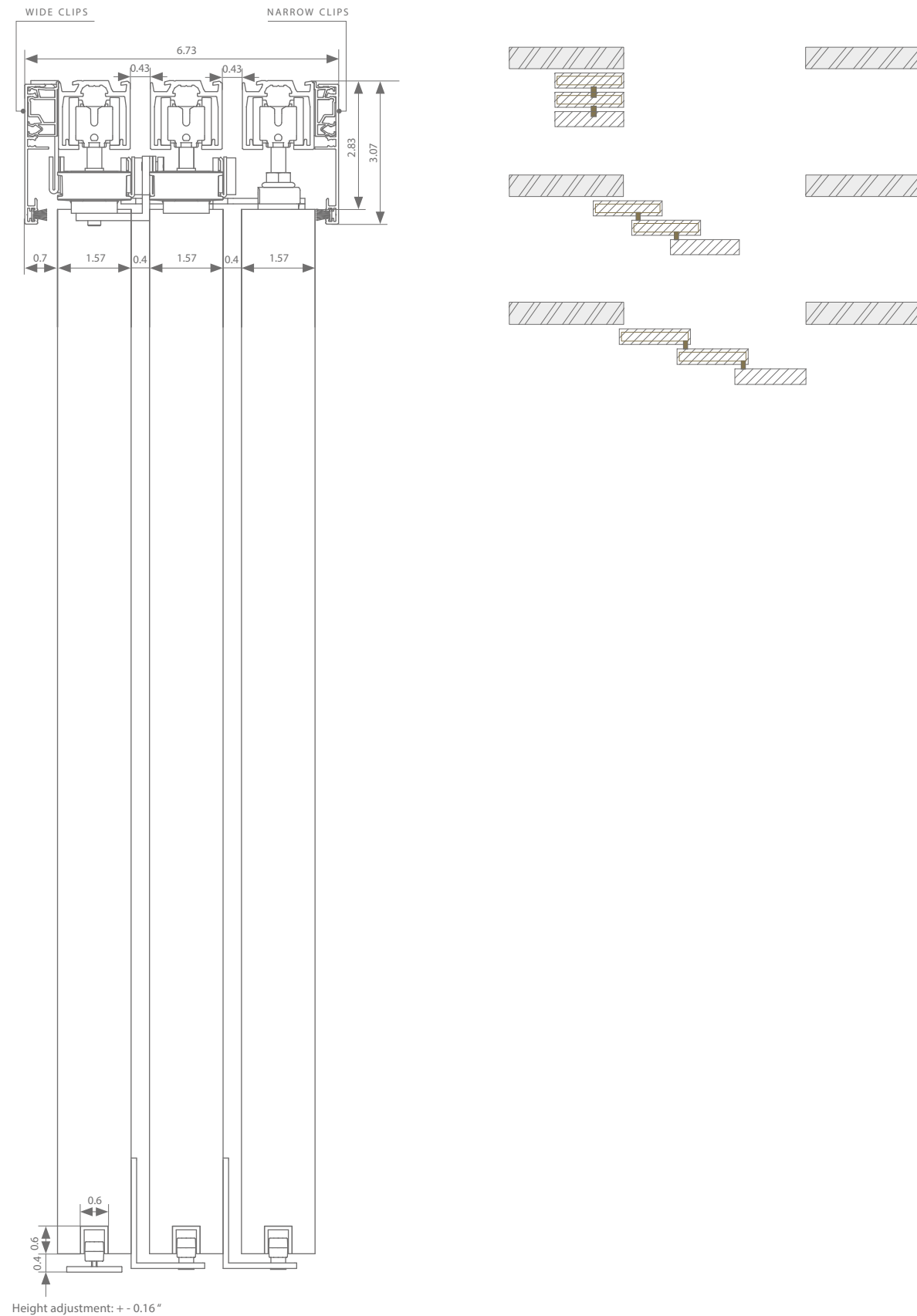
Technical drawings



Profiles

	Max. door width	Length			
3 x running track	19.7"	78.7"	AAA.11000200.02	AAA.11000200.07	AAA.11000200.05
	29.5"	118.1"	AAA.11000300.02	AAA.11000300.07	AAA.11000300.05
	39.4"	157.5"	AAA.11000400.02	AAA.11000400.07	AAA.11000400.05
	59"	236.2"	AAA.11000600.02	AAA.11000600.07	AAA.11000600.05
3x ESSI®-module (optional)		3.94"	AAA.11010010.02	AAA.11010010.07	AAA.11010010.05
2 x cover profile	19.7"	78.7"	AAA.12000200.02	AAA.12000200.07	AAA.12000200.05
	29.5"	118.1"	AAA.12000300.02	AAA.12000300.07	AAA.12000300.05
	39.4"	157.5"	AAA.12000400.02	AAA.12000400.07	AAA.12000400.05
	59"	236.2"	AAA.12000600.02	AAA.12000600.07	AAA.12000600.05
+ narrow clips 1 per metre of cover profile		3.94"		AAA.12010010.07	
+ wide clips 1 per metre of cover profile		3.94"		AAA.12020010.07 AAA.12020100.07	
2 x seal	19.7"	78.7"	AAA.12010200.02	AAA.12010200.07	
	29.5"	118.1"	AAA.12010300.02	AAA.12010300.07	
	39.4"	157.5"	AAA.12010400.02	AAA.12010400.07	
	59"	236.2"	AAA.12010600.02	AAA.12010600.07	
3 x bottom guiding track	39.4"	39.4"	AAA.15000100.00		
	49.2"	49.2"	AAA.15000125.00		
	59"	59"	AAA.15000150.00		
	78.7"	78.7"	AAA.15000200.00		
	118.1"	118.1"	AAA.15000300.00		
236.2"	236.2"	AAA.15000600.00			

Fittings selection

	Transverse suspension	Min. door width	Min. door width ESSI	Length	Reference
	3 x telescopic	1 x necessary	16.8"	18.6"	AAA.20005000.00
	Belt	Min. belt length = (4 x door width) + 15.7"		1968.5" 787.4" 393.7"	AK9.709.050 AK9.709.020 AK9.709.010

Motorised set\*

	Transverse suspension with motor	Min. door width	Min. door width ESSI	Length	Reference
Fittings	A-slide** (max. 88.2 lbs/door, 1 x necessary)	26.9"	28"		AAA.20033000.00
Belt	Min. belt length = (12 x door width) + 23.6"			1968.5" 787.4" 393.7"	AK9.709.050 AK9.709.020 AK9.709.010
Remote control	for 1 channel				AM3.100.104.61
	for 4 channels				AM3.100.104.2.52

\* see p.68 for more information      Every fitting set comes with all the rollers or softclose mechanisms, suspension, guiding systems and stoppers you need.  
\*\* Cannot be combined with cover profiles and end caps

Technical drawings

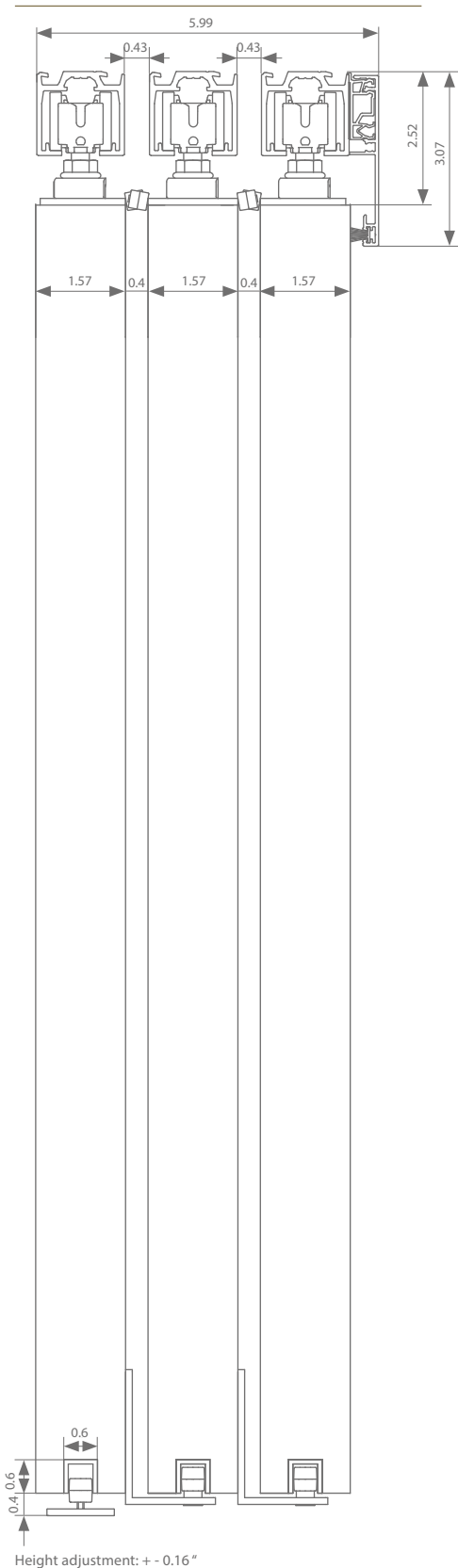

Parallel ceiling mount 1

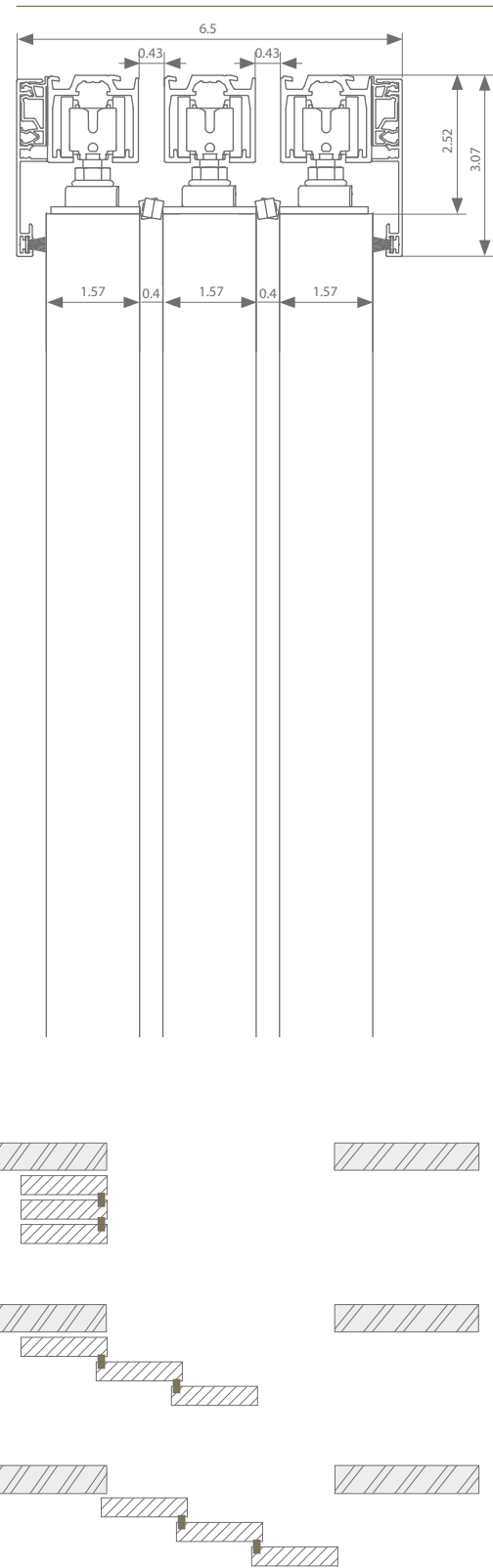

Parallel ceiling mount 2



Profiles

	Max. door width	Length			
3 x running track	19.7"	78.7"	AAA.11000200.02	AAA.11000200.07	AAA.11000200.05
	29.5"	118.1"	AAA.11000300.02	AAA.11000300.07	AAA.11000300.05
	39.4"	157.5"	AAA.11000400.02	AAA.11000400.07	AAA.11000400.05
	59"	236.2"	AAA.11000600.02	AAA.11000600.07	AAA.11000600.05
	3xESSI®-module (optional)	3.94"	AAA.11010010.02	AAA.11010010.07	AAA.11010010.05
2 x cover profile	19.7"	78.7"	AAA.12000200.02	AAA.12000200.07	AAA.12000200.05
	29.5"	118.1"	AAA.12000300.02	AAA.12000300.07	AAA.12000300.05
	39.4"	157.5"	AAA.12000400.02	AAA.12000400.07	AAA.12000400.05
	59"	236.2"	AAA.12000600.02	AAA.12000600.07	AAA.12000600.05
	+ narrow clips 1 per metre of cover profile	3.94"		AAA.12010010.07	
2 x seal	19.7"	78.7"	AAA.12010200.02	AAA.12010200.07	
	29.5"	118.1"	AAA.12010300.02	AAA.12010300.07	
	39.4"	157.5"	AAA.12010400.02	AAA.12010400.07	
	59"	236.2"	AAA.12010600.02	AAA.12010600.07	
	3 x bottom guiding track	39.4"	39.4"	AAA.15000100.00	
49.2"		49.2"	AAA.15000125.00		
59"		59"	AAA.15000150.00		
78.7"		78.7"	AAA.15000200.00		
118.1"		118.1"	AAA.15000300.00		
236.2"		236.2"	AAA.15000600.00		

Fittings selection



Transverse suspension		Min. door width	Min. door width ESSI	Reference	
	With 2 stoppers	3 x necessary	13"	16.7"	AAA.20000000.00
	With double-action softclose	3 x necessary	26"	27.3"	AAA.20020000.00
+ 3 x parallel		1 x necessary			AAA.20004000.00

Every fitting set comes with all the rollers or softclose mechanisms, suspension, guiding systems and stoppers you need.

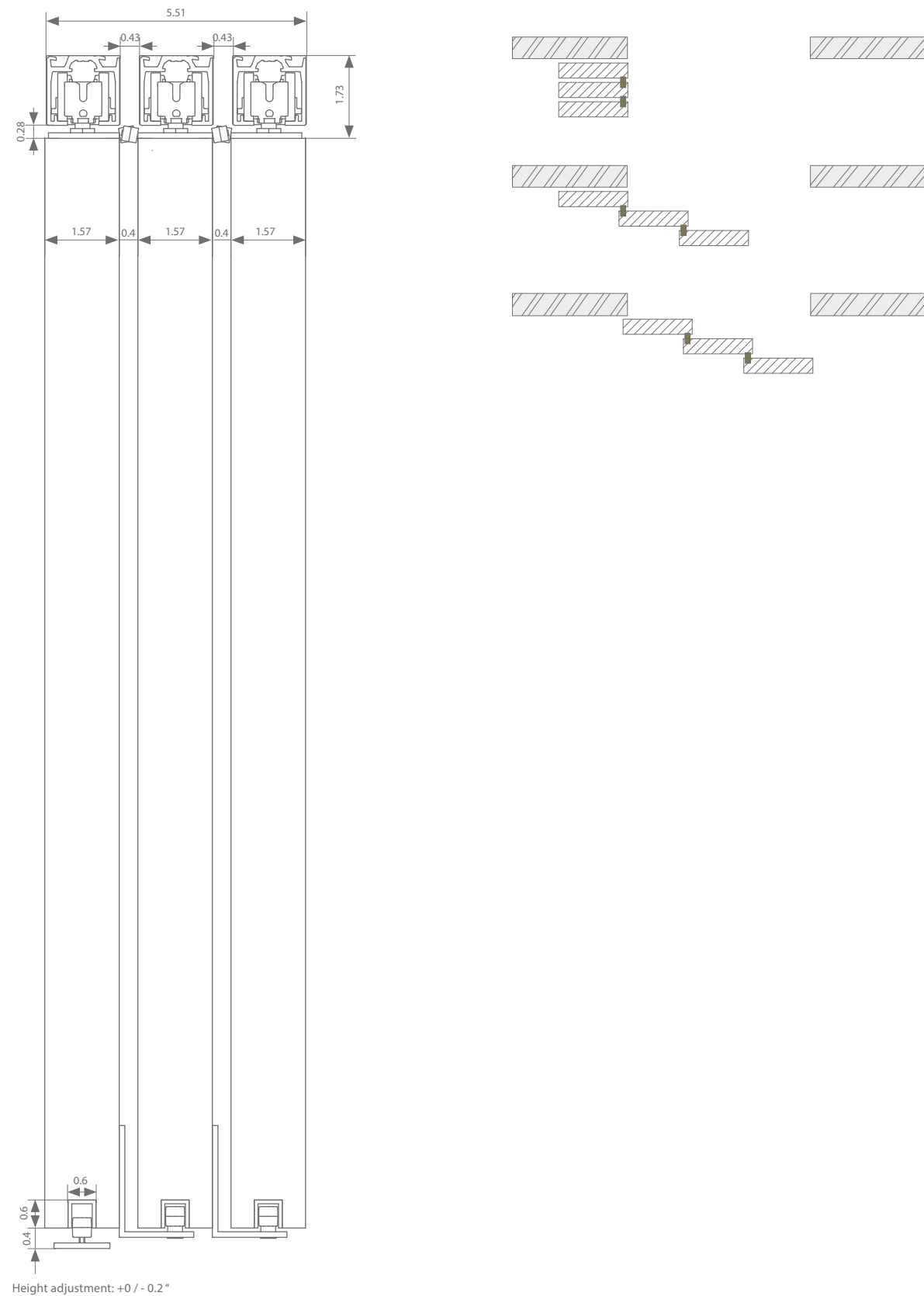
Technical drawings



Profiles

	Max. door width	Length			
3 x running track	19.7"	78.7"	AAA.11000200.02	AAA.11000200.07	AAA.11000200.05
	29.5"	118.1"	AAA.11000300.02	AAA.11000300.07	AAA.11000300.05
	39.4"	157.5"	AAA.11000400.02	AAA.11000400.07	AAA.11000400.05
	59"	236.2"	AAA.11000600.02	AAA.11000600.07	AAA.11000600.05
3 x ESSI®-module (optional)		3.94"	AAA.11010010.02	AAA.11010010.07	AAA.11010010.05
3 x bottom guiding track	39.4"	39.4"	AAA.15000100.00		
	49.2"	49.2"	AAA.15000125.00		
	59"	59"	AAA.15000150.00		
	78.7"	78.7"	AAA.15000200.00		
	118.1"	118.1"	AAA.15000300.00		
	236.2"	236.2"	AAA.15000600.00		

Fittings selection

Transverse suspension			Min. door width	Min. door width ESSI	Reference
	Manual-Fix	With 2 stoppers 3 x necessary	13.6"	17.6"	AAA.20100000.00
		Double-action softclose 3 x necessary	26.5"	28"	AAA.20120000.00
	Auto-Fix	With 2 stoppers 3 x necessary	13.6"	17.6"	AAA.20200000.00
		Double-action softclose 3 x necessary	26.5"	28"	AAA.20220000.00
+ 3 x parallel		1 x necessary			AAA.20004000.00

Every fitting set comes with all the rollers or softclose mechanisms, suspension, guiding systems and stoppers you need.

# a-slide MOTORISATION

The a-slide is the intelligent motorisation system for Xperta. The motor is mounted at the end of the Xperta running track and connected to the door leaf via a belt. One single a-slide can drive a single door, a symmetrical double door or a telescopic system, with a maximum combined door weight of 264.6 lbs.

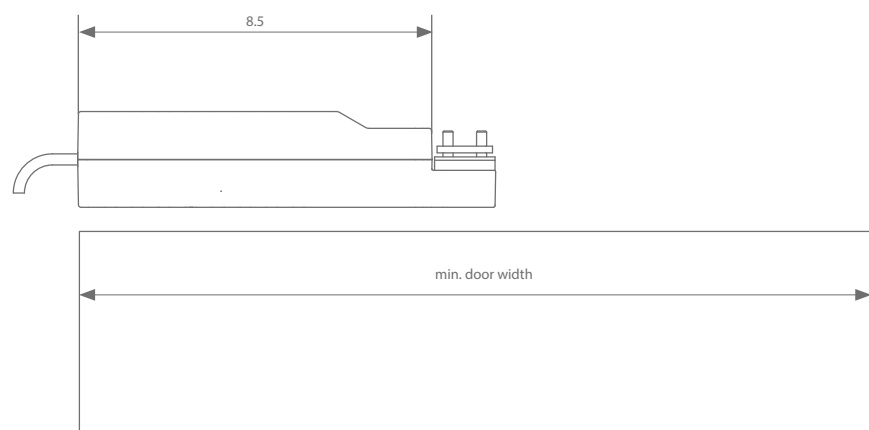

The a-slide can be operated with a wired push button or wirelessly with the optional remote control. When connected to a suitable switch module, the motor can also be integrated into a home automation system. Once connected, the motor is immediately ready for use. The handy ARLU® app allows for easy adjustment of the automatic sliding door settings to any situation.



DOWNLOAD APP

Max. weight	264.6 lbs
Connection	230V AC ~50HZ / 50W
Movement	Straight-sliding Symmetrical Telescopic
Remote controls	Switching via phase wire or remote control ARLU-app (Bluetooth and WiFi-interface)
Mode	Standard Self-closing
Speed	Adjustable up to 30 cm/s

## Basic motorised set\*

		Length	Reference
Fittings	A-slide		AAA.20030000.00
Belt	Min. belt length = (4 x door width) + 7.9"	1968.5"	AK9.709.050
		787.4"	AK9.709.020
		393.7"	AK9.709.010
Remote control	for 1 channels		AM3.100.104.61
	for 4 channels		AM3.100.104.2.52

Every fitting set comes with all the rollers or softclose mechanisms, suspension, guiding systems and stoppers you need.  
\* Items for symmetric and telescopic doors, see previous pages..

# 02

## XPERTA GLASS

As a specialist in sliding door systems, ARLU® has provided as well solutions for glass sliding doors in the Xperta range. Market needs have again been taken into account here, and benefits such as the double-action silent softclose feature have been included. The glass panels are suspended from a unique glass clamp that is suitable for glass thicknesses of 0.31, 0.39 and 0.47".





argenta xperta glass  
why choose Xperta?

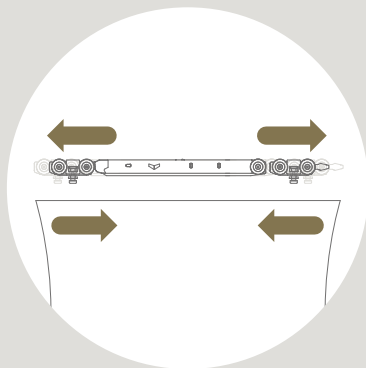

**DOUBLE-ACTION  
SOFTCLOSE**

for gentle opening and closing of doors. The compact design makes it suitable for extremely narrow doors.

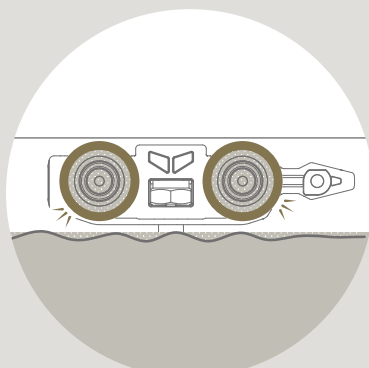

**MINIMUM ROLLING  
RESISTANCE,  
MAXIMUM NOISE  
REDUCTION**

thanks to wheels with a hard running surface and soft core.

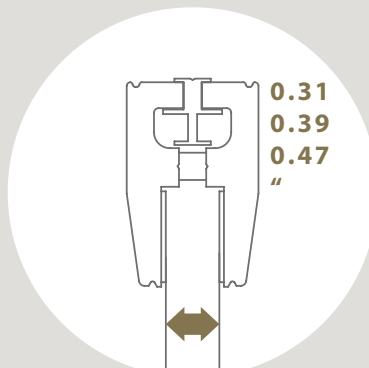

**UNIVERSAL  
GLASS CLAMP**

for 0.31, 0.39 or 0.47" glass

Quick (dis)assembly thanks to the ESSI® module

Separate activator channel

**TIP**



You can use connection piece AAA.11011000.00 to connect two profiles in line.

Easy clip-in system

Soft U-guide

Available in three colours  
F1 anodised aluminium, black  
and white textured coating



Xperta is a universal solution for glass doors up to 220 lbs. The unique running track and silent rollers ensure optimal movement of every sliding door. Xperta can be mounted with matching wall and cover profiles, or with the running track directly under the ceiling.

The Xperta invisible running track allows for an even sleeker finish in a suspended ceiling.



# Xperta SINGLE DOOR

Xperta sliding doors stand out for their quiet operation, versatility, intuitive installation, sleek design and durability. The double-action softclose makes the operation even more comfortable. Glass panels of 0.31, 0.39 and 0.47 " can be applied thanks to the universal glass clamps. These clamps can be hidden behind a cover profile with end pieces.

PROFILE LENGTH

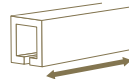

78.7 | 118.1 |  
157.5 | 236.2"

INSTALLATION



DOOR WEIGHT



anodised aluminium

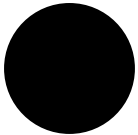

black textured coating  
RAL 9005



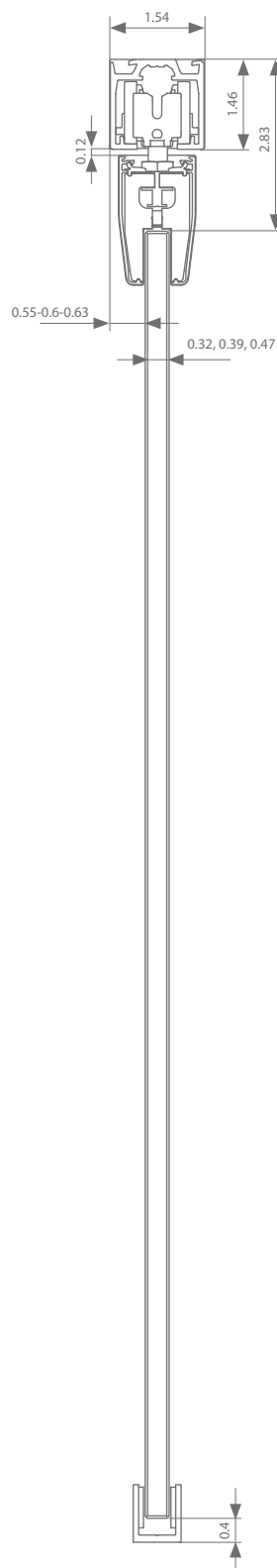

white textured coating  
RAL 9016

Technical drawings



Height adjustment: + 0 / - 0.2"

Profiles

	Max. door width	Length			
<b>Running track</b>	39.4"	78.7"	AAA.11000200.02	AAA.11000200.07	AAA.11000200.05
	59"	118.1"	AAA.11000300.02	AAA.11000300.07	AAA.11000300.05
	78.7"	157.5"	AAA.11000400.02	AAA.11000400.07	AAA.11000400.05
	118.1"	236.2"	AAA.11000600.02	AAA.11000600.07	AAA.11000600.05
<b>ESSI®-module (optional)</b>		3.94"	AAA.11010010.02	AAA.11010010.07	AAA.11010010.05
<b>Set of end caps</b>			AAA.91000000.02	AAA.91000000.07	AAA.91000000.05
<b>Cover profile</b>	39.4"	78.7"	AAB.12100200.02	AAB.12100200.07	AAB.12100200.05
	59"	118.1"	AAB.12100300.02	AAB.12100300.07	AAB.12100300.05
	78.7"	157.5"	AAB.12100400.02	AAB.12100400.07	AAB.12100400.05
	118.1"	236.2"	AAB.12100600.02	AAB.12100600.07	AAB.12100600.05
<b>Glass thickness</b>					
<b>End cap glass clamp</b>		0.31"	AAB.92110000.02	AAB.92110000.07	AAB.92110000.05
		0.39"	AAB.92120000.02	AAB.92120000.07	AAB.92120000.05
		0.47"	AAB.92130000.02	AAB.92130000.07	AAB.92130000.05

Fittings selection

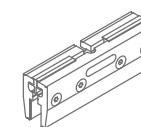

Compact suspension	Min. door width	Min. door width ESSI	Reference
With 2 stoppers	14.4"	17.8"	AAB.20000000.00
With double-action softclose	24.1"	26.4"	AAB.20020000.00

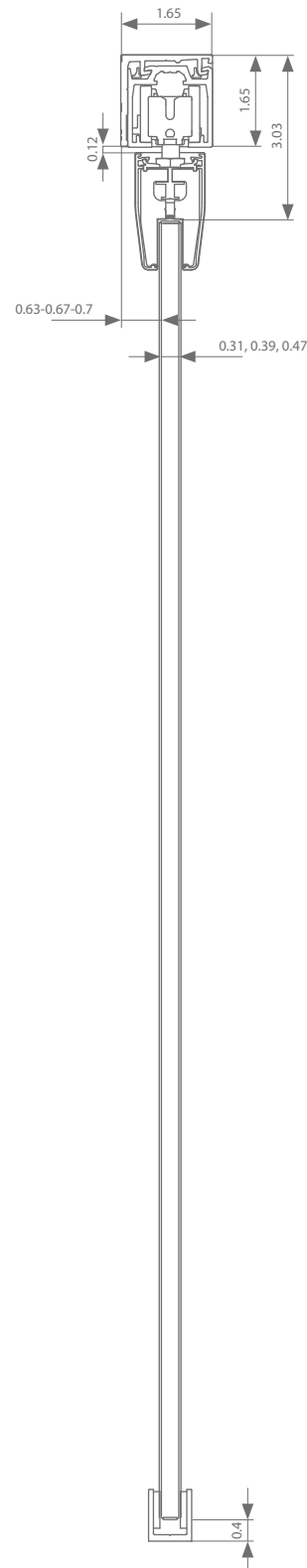

Every fitting set comes with all the rollers or softclose mechanisms, suspension, guiding systems and stoppers you need.

Technical drawings



Height adjustment: + 0 / - 0.2"

Profiles

	Max. door width	Length			
<b>Running track</b>	39.4"	78.7"	AAA.11000200.02	AAA.11000200.07	AAA.11000200.05
	59"	118.1"	AAA.11000300.02	AAA.11000300.07	AAA.11000300.05
	78.7"	157.5"	AAA.11000400.02	AAA.11000400.07	AAA.11000400.05
	118.1"	236.2"	AAA.11000600.02	AAA.11000600.07	AAA.11000600.05
<b>ESSI®-module (optional)</b>		3.94"	AAA.11010010.02	AAA.11010010.07	AAA.11010010.05
<b>Wall profile</b>	39.4"	78.7"	AAB.13200200.02	AAB.13200200.07	AAB.13200200.05
	59"	118.1"	AAB.13200300.02	AAB.13200300.07	AAB.13200300.05
	78.7"	157.5"	AAB.13200400.02	AAB.13200400.07	AAB.13200400.05
	118.1"	236.2"	AAB.13200600.02	AAB.13200600.07	AAB.13200600.05
<b>+ mounting set</b>			AAA.13010000.07		
<b>Set of end caps</b>			AAB.93200000.02	AAB.93200000.07	AAB.93200000.05
<b>Cover profile</b>	39.4"	78.7"	AAB.12100200.02	AAB.12100200.07	AAB.12100200.05
	59"	118.1"	AAB.12100300.02	AAB.12100300.07	AAB.12100300.05
	78.7"	157.5"	AAB.12100400.02	AAB.12100400.07	AAB.12100400.05
	118.1"	236.2"	AAB.12100600.02	AAB.12100600.07	AAB.12100600.05
<b>Glass thickness</b>					
<b>End cap glass clamp</b>		0.31"	AAB.92110000.02	AAB.92110000.07	AAB.92110000.05
		0.39"	AAB.92120000.02	AAB.92120000.07	AAB.92120000.05
		0.47"	AAB.92130000.02	AAB.92130000.07	AAB.92130000.05

Fittings selection

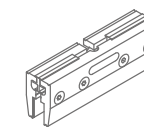

Compact suspension	Min. door width	Min. door width ESSI	Reference
With 2 stoppers	14.4"	17.8"	AAB.20000000.00
With double-action softclose	24.1"	26.4"	AAB.20020000.00

Every fitting set comes with all the rollers or softclose mechanisms, suspension, guiding systems and stoppers you need.





## Xperta FLUSH INTO CEILING

The Xperta invisible glass is the ultimate solution for ceiling high applications where the profile is seamlessly integrated into a suspended ceiling. The profile can be finished with standard plasterboard, or whatever skirting that might be chosen.

PROFILE LENGTH

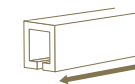

78.7 | 118.1 |  
157.5 | 236.2"

INSTALLATION



DOOR WEIGHT

MAX.  
**220**  
LBS



grey anodised  
aluminium

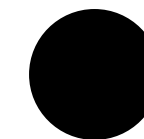

black anodised  
aluminium



white matte coating  
RAL 9016

Technical drawings

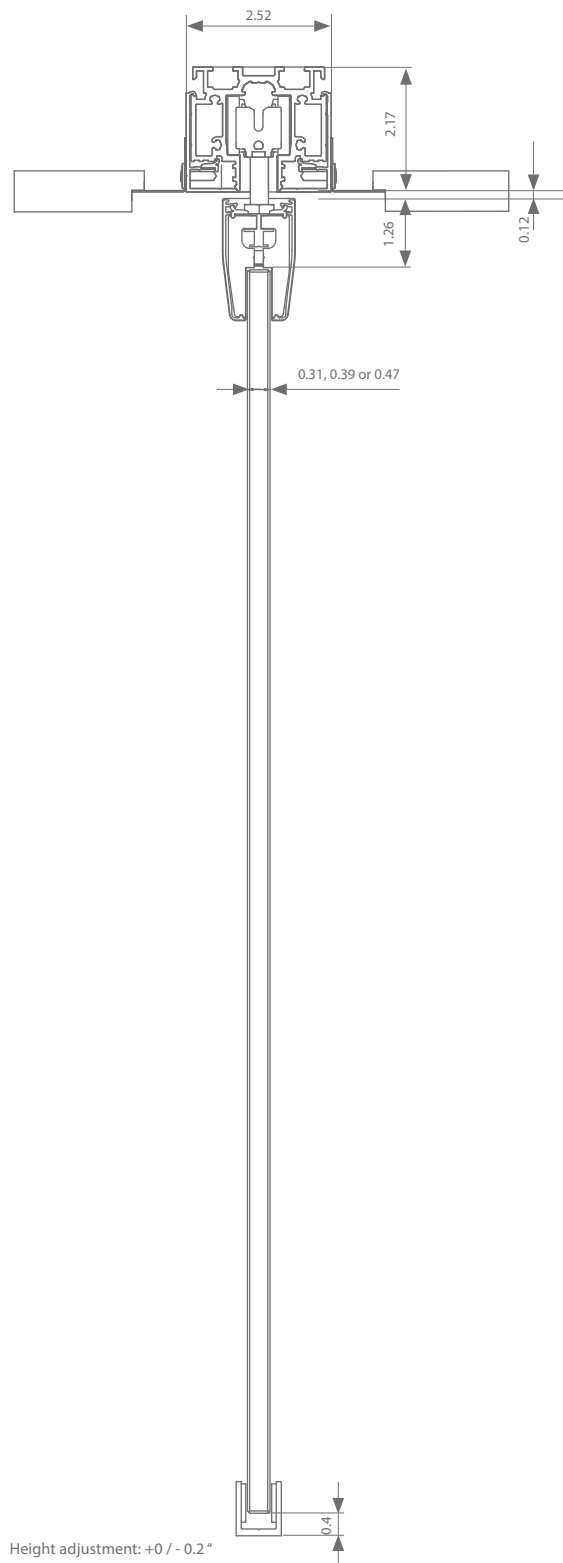

For suspended ceiling (1+2)

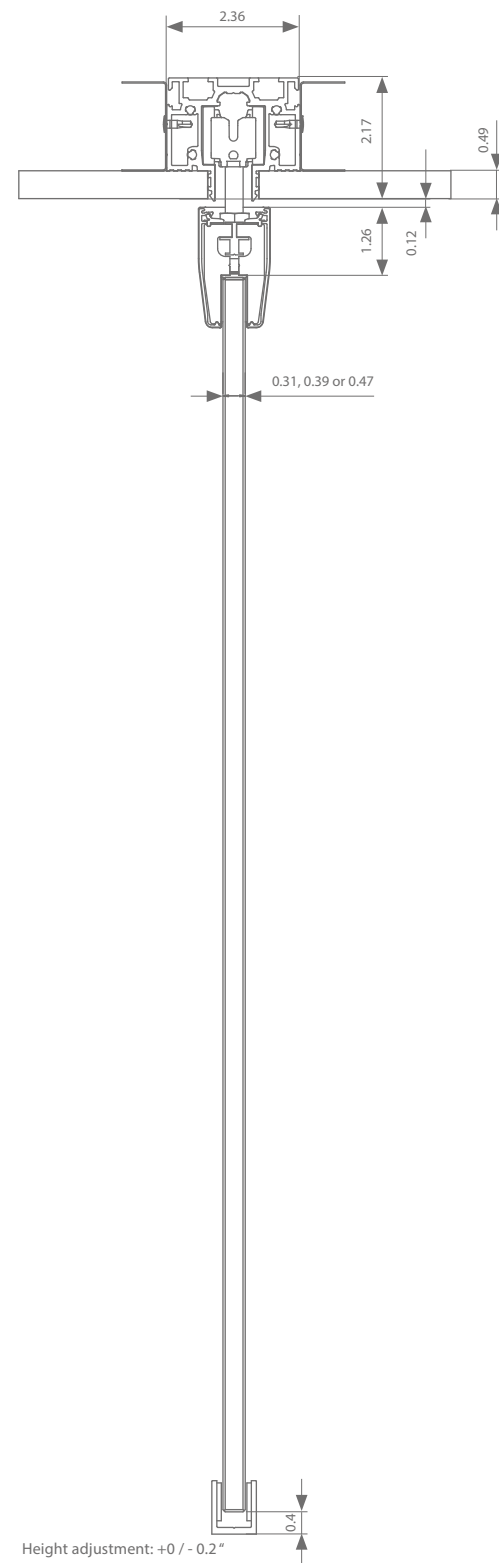

For plasterboard (1)



Profiles

	Max. door width	Length			
<b>Running track (1)</b>	39.4"	78.7"	AAA.11100200.02	AAA.11100200.07	AAA.11100200.05
	59"	118.1"	AAA.11100300.02	AAA.11100300.07	AAA.11100300.05
	78.7"	157.5"	AAA.11100400.02	AAA.11100400.07	AAA.11100400.05
	118.1"	236.2"	AAA.11100600.02	AAA.11100600.07	AAA.11100600.05
<b>ESSI®-module</b>		3.94"	AAA.11110010.02	AAA.11110010.07	AAA.11110010.05
<b>2 x extra cover profile for suspended ceilings (2)</b>	39.4"	78.7"			AAA.11120200.05
	59"	118.1"			AAA.11120300.05
	78.7"	157.5"			AAA.11120400.05
	118.1"	236.2"			AAA.11120600.05
<b>+ 2 x for ESSI</b>					AAA.11113010.05
<b>Cover profile</b>	39.4"	78.7"	AAB.12100200.02	AAB.12100200.07	AAB.12100200.05
	59"	118.1"	AAB.12100300.02	AAB.12100300.07	AAB.12100300.05
	78.7"	157.5"	AAB.12100400.02	AAB.12100400.07	AAB.12100400.05
	118.1"	236.2"	AAB.12100600.02	AAB.12100600.07	AAB.12100600.05
<b>Glass thickness</b>					
<b>End cap glass clamp</b>		0.31"	AAB.92110000.02	AAB.92110000.07	AAB.92110000.05
		0.39"	AAB.92120000.02	AAB.92120000.07	AAB.92120000.05
		0.47"	AAB.92130000.02	AAB.92130000.07	AAB.92130000.05

\* black textured coating RAL 9005, white textured coating RAL 9016

Fittings selection

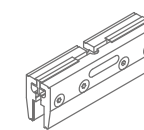

Compact suspension	Min. door width	Min. door width ESSI	Reference
With 2 stoppers	14.4"	17.8"	AAB.20000000.00
With double-action softclose	24.1"	26.4"	AAB.20020000.00

Every fitting set comes with all the rollers or softclose mechanisms, suspension, guiding systems and stoppers you need.



# NOTES

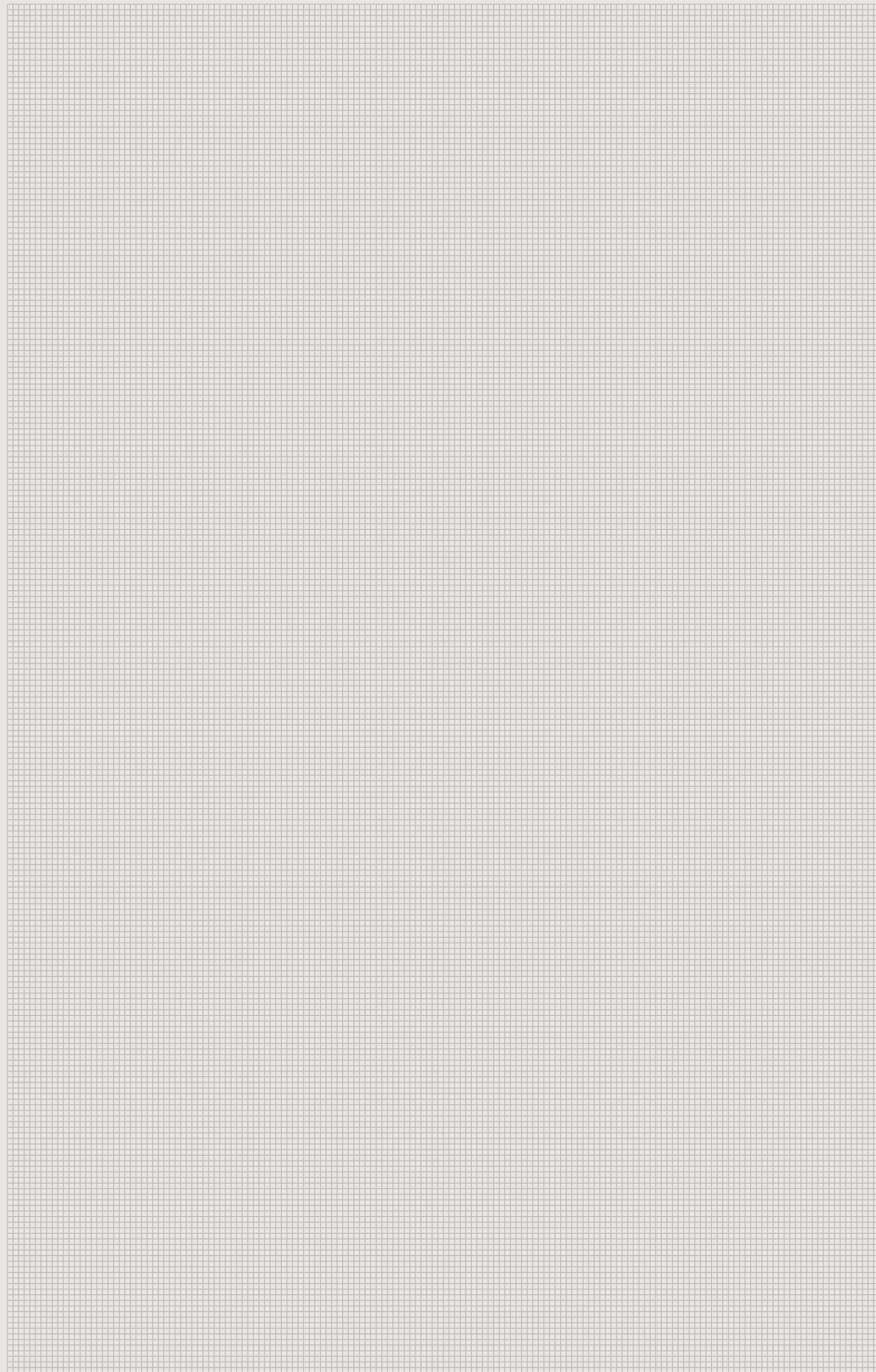

# NOTES

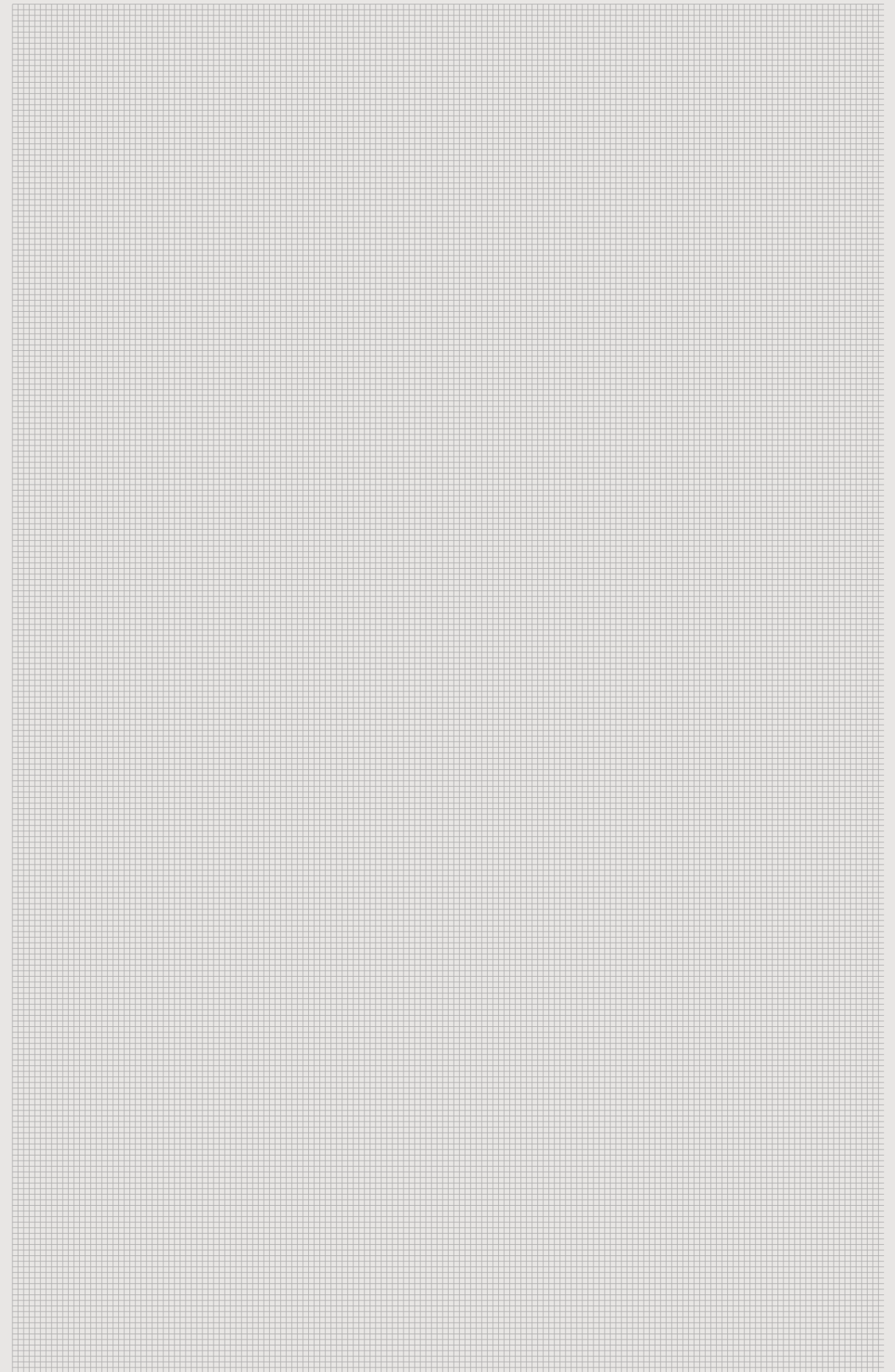



Ter Vlucht 2 +32 (0)51 27 05 00  
8850 Ardoois info@arlu.be  
Belgium WWW.ARLU.BE

